

# STERILIZATION OF MEDICAL PRODUCTS



# STERILIZATION OF MEDICAL PRODUCTS

## Volume VII

### **Editors:**

Robert F. Morrissey, Ph.D.

John B. Kowalski, Ph.D.

Johnson & Johnson

Sterilization Science & Technology

U.S.A.

Johnson & Johnson

**Proceedings of the International Kilmer Memorial Conference on the Sterilization of  
Medical Products**

**Scottsdale, Arizona**

**March 2-4, 1998**

® Johnson & Johnson 1998

ISBN 0-921-317-80-8

**Polyscience Publications Inc.  
Champlain, N.Y.**

Printed in Canada.

# Contents

## Copyright

## Preface

## Opening Session

Opening Remarks

James T. Lenehan

Fred B. Kilmer – Infection Control Pioneer

Robert F. Morrissey

Keynote Address

Joshua Lederberg

## Session I – Emerging Infectious Diseases

A Global View of Emerging Infections and Antimicrobial Resistance

James M. Hughes

Emerging Infectious Diseases: An Overview

Maria Neira and David L. Heymann

Controlling Antimicrobial Resistance in Health Care Systems — A Multifaceted Problem

John E. McGowan, Jr.

Experimental Inoculation of Plants and Animals with Ebola Virus

Robert Swanepoel, Patricia A. Leman, Felicity J. Burt, Nicholas A. Zachariades, Lawrence E.O. Braack, Thomas G. Ksiazek, Pierre E. Rollin, Sherif R. Zaki, and Clarence J. Peters

Emergence of Rodent-borne Viruses: Arenavirus and Hantavirus Infection in South America

Delia A. Enria and Silvana C. Levis

Borna Disease Infection in Humans

W. Ian Lipkin and Carolyn G. Hatalski

Dengue Hemorrhagic Fever

Suchitra Nimmannitya

Tick-borne Diseases: The Emergence of Human Granulocytic Ehrlichiosis

J. Stephen Dumler

## Discussion – Emerging Infectious Diseases

## **Session II – The Biology and Inactivation of Prions**

The Prion Diseases of Animals and Humans

Stanley B. Prusiner

Epidemiology of Creutzfeldt-Jakob Disease

Robert G. Will

Iatrogenic Creutzfeldt-Jakob Disease

Paul Brown

Inactivation of the Causal Agents of Transmissible Spongiform Encephalopathies

David M. Taylor

Inactivation of Prions by Hyperbaric Rendering Procedures

B.E.C. Schreuder, R. E. Geertsma, L.J.M. van Keulen, J.A.A.M. van Asten, P. Enthoven, R.C. Oberthür, A.A. de Koeijer, and A.D.M.E. Osterhaus

Discussion – The Biology and Inactivation of Prions

## **Session III – Emerging Sterilization Issues & Technologies**

Introduction – Emerging Sterilization Issues & Technologies

Eamonn V. Hoxey

Radiation Dose Setting/Substantiation Methods: Have We Got It Right?

Alan Tallentire

Viral Safety of Biological Products

Thomas J. Lynch

Resistance “Creep” of Biological Indicators

Nigel A. Halls

Low-Temperature Sterilization Technologies

William A. Rutala and David J. Weber

Sterilization of Medical Devices, Pharmaceutical Components, and Barrier Isolation Systems with Gaseous Chlorine Dioxide

John B. Kowalski

Development of Biological and Chemical Indicators for Monitoring Vapor-Phase Hydrogen Peroxide Sterilization Processes and Evaluation of Performance Using a Biological Indicator Evaluator Resistometer Vessel

Thomas B. May and Michael S. Korczynski

Global Harmonization of Premarket Review of Sterilization Technology

Timothy A. Ulatowski

Discussion – Emerging Sterilization Issues & Technologies

## **General Discussion**

## **Comments from Prof. Alan Tallentire – Recipient of the 1998 Kilmer Memorial Award**

Single user license provided by AAMI. Further copying, networking, and distribution prohibited.



# Preface

By all accounts, the Seventh International Kilmer Memorial Conference was the most compelling to date, set on the centennial anniversary of the publication of Kilmer's classic paper entitled *Modern Surgical Dressings*. Two Nobel Laureates participated—Joshua Lederberg presided as the Conference General Chairman and Stanley Prusiner provided insight into the biological enigma of prions.

The Conference was devoted to three themes: Emerging Infectious Diseases, Biology and Inactivation of Prions, and Emerging Sterilization Issues & Technologies. The program consisted of 22 invited speakers from seven countries, representing such diverse organizations as the World Health Organization, the Centers for Disease Control and Prevention, the National Institutes of Health, the Food and Drug Administration, academia, medicine, and the health care industry.

In addition to the papers published in these proceedings, the reader is encouraged to review the discussion sections to get a flavor of the spirited interaction between the delegates and speakers especially on the topics of newly emerging infectious diseases, microbial resistance to antibiotics, and speculation as to the ultimate impact of prion diseases on humanity.

The highlight of the Conference was the presentation of the Kilmer Award to Professor Alan Tallentire, former Graduate Dean and Professor of Pharmacy at the University of Manchester, *for excellence in advancing research, education, and international standardization of sterilization science*. Professor Tallentire has conducted pioneering work in the fields of radiation biology, aerobiology, and sterilization science, and has been a tireless global educator.

These proceedings from the seventh Conference are dedicated to Dr. Eugene R. L. Gaughran. Throughout his 33-year tenure at Johnson & Johnson, Dr. Gaughran was a champion of and innovator in the field of medical product sterilization. Among his many and varied contributions was the creation of the International Kilmer Memorial Conference.

New Brunswick, NJ

R.F. Morrissey, Ph.D.  
J.B. Kowalski, Ph.D.

**Conference General Chairman**

Joshua Lederberg, Ph.D.  
*The Rockefeller University, U.S.A.*

**Opening Session**

**Opening Remarks**

**James T. Lenehan**  
*Johnson & Johnson, U.S.A.*

**Fred B. Kilmer – Infection Control Pioneer**

**Robert F. Morrissey, Ph.D.**  
*Johnson & Johnson, U.S.A.*

**Keynote Address**

**Joshua Lederberg, Ph.D.**  
*The Rockefeller University, U.S.A.*





# Opening Remarks

James T. Lenehan

*Johnson & Johnson, U.S.A.*

It is a privilege for me to welcome such a distinguished group of speakers, delegates, and Kilmer Award recipients to the Seventh International Kilmer Memorial Conference. To our many colleagues visiting from overseas, welcome to the sunny American Southwest.

The Conference was last held in the United States in 1980, and it is very fitting that we commemorate the centennial of the publication of Kilmer's classic work, *Modern Surgical Dressings*, by holding the 1998 Conference here in Scottsdale.

The objective during our three days of deliberations is consistent with prior Kilmer Conferences, namely, to provide a forum for the sharing of scientific information that has a direct bearing on the health and well-being of people around the world, with special emphasis on the prevention of infection through intervention in the disease transmission process.

This week's program consists of 22 invited speakers from seven countries, representing such diverse organizations as the World Health Organization (WHO), the Centers for Disease Control and Prevention (CDC), the National Institutes of Health, the Food and Drug Administration, academia, medicine, and the health care industry.

We thank Professor Joshua Lederberg for agreeing to serve as Conference General Chairman and for the participation of Dr. James Hughes, the Assistant Surgeon General and Director of the National Center for Infectious Diseases — the architect of the CDC's program to control emerging and re-emerging infectious diseases.

This Conference is actually the ninth undertaking that Johnson & Johnson has been associated with over a span of 24 years devoted to the theme of infection control and sterilization science — subjects that have their roots deep in the history of our enterprise.

Many of you may be wondering why Johnson & Johnson would sponsor such an event. Beginning as it did in 1886, in the infancy of modern medicine, Johnson & Johnson joined physicians in the struggle against disease and infection. It was a time when life itself was fragile, and the most modest medical advances reaped huge rewards in terms of lives saved. Probably no area of human progress has made such remarkable gains over the past 112 years as has medical science — going as it has from virtual ignorance to vast knowledge of the human body and now its genetic constituents. Contributing to that progress, Johnson & Johnson developed the first ready-to-use surgical dressings in the mid-1880s which marked the first practical application of the theory of antiseptic wound treatment.

Years later, in the mid-1950s, our Ethicon division pioneered the first industrial application of ionizing radiation for the sterilization of medical products by using an electron accelerator to sterilize surgical sutures. More recently, Ethicon advanced minimally-invasive

surgical procedures to reduce surgery time and thus the potential for nosocomial infections. As a corporation, we continue to develop new sterilization technologies and equipment to meet the surgical requirements of the future.

At Johnson & Johnson, we have a long-term outlook in managing the business and are guided in our everyday conduct and social responsibility decisions by a Corporate Credo. The Credo, originally written by General Robert Wood Johnson in the 1940s, is a reminder of our responsibilities to four constituencies: our customers, our employees, the communities in which we live and work, and our stockholders.

We are the world's largest and most comprehensive manufacturer of health care products serving the consumer, pharmaceutical, diagnostic, and professional markets. As a whole, we employ over 90,000 people across more than 180 operating companies in 51 countries around the world, and market products in more than 175 countries.

Against that backdrop you can better understand why we are pleased to be able to help provide this forum for the exchange of knowledge about improved health care through infection control.

Around the world, people have come to expect to live longer and healthier lives. Few scientific meetings are capable of having a direct impact on these expectations. This Conference, however, is an exception. As a group, you have great potential to positively impact human health and well-being.

Infectious diseases are the leading cause of death worldwide. In 1992, the Institute of Medicine reported that the United States, as well as many parts of the world, have become unjustifiably complacent with public health strategies for controlling infectious diseases. The report went on to say: *"Pathogenic microbes can be resilient, dangerous foes. Although it is impossible to predict their individual emergence in time and place, we can be confident that new microbial diseases will emerge."*

Many factors, or combinations of factors, contribute to disease emergence. Newly emergent infectious diseases may result either when existing organisms change or evolve, or when known diseases spread to new geographic areas or new human populations. Previously unrecognized infections may appear in persons living or working in areas undergoing ecological changes. Deforestation or reforestation are examples of ecological changes that may cause people to increase their exposure to insects, animals, or environmental sources that may harbor new or unusual infectious agents. Re-emergence of infectious diseases may also occur because of the development of antimicrobial resistance in known pathogens or breakdowns in public health measures for previously controlled infections.

They say that hindsight is 20/20, and therefore it is relatively easy to view events that have impacted human health over the course of the past 100 years or so. Who would have imagined, however, that during the tenure of the Kilmer Conferences the human species would be challenged with such emerging and re-emerging infectious diseases as Acquired Immunodeficiency Syndrome (AIDS), Legionnaire's disease, toxic shock syndrome, Hantavirus Pulmonary Syndrome (HPS), Lyme disease, Ebola, Hepatitis C, multi-drug resistant tuberculosis, and diphtheria.

For example, several recent reports from WHO and the World Bank have dramatically

revised upwards the estimates of worldwide infections with the human immunodeficiency virus (HIV) and cases of AIDS. The World Bank is a major funding source for AIDS prevention programs, having committed \$632 million by year end 1996. It is believed that there are more than 30 million people infected with HIV worldwide, with 16,000 individuals infected per day.

Lyme disease was first recognized in the United States in 1975 after a mysterious outbreak of arthritis near Lyme, Connecticut. Subsequently, reports of Lyme disease increased rapidly, and the disease has become the most commonly reported vector-borne infectious disease in the United States.

Hantavirus Pulmonary Syndrome was first detected in the southwestern United States in 1993. It has been linked with exposure to infected rodents in more than a dozen states and cases continue to be detected. More than half of the persons infected in the United States have died. HPS has also been recognized in Canada and other countries.

People in developed countries are so accustomed to safe, clean, and plentiful water supplies that we only think about water when a problem arises. Outbreaks of gastrointestinal illness due to contaminated municipal water, however, still occur in the United States. The largest recorded water-borne disease outbreak in our nation's history occurred in Milwaukee, Wisconsin, in April 1993. The disease was cryptosporidiosis, a parasitic infection of the small intestine. This outbreak affected over 400,000 people, with more than 4,400 people hospitalized.

Clearly, there is much more work to be done to stay abreast of disease-causing microorganisms and their all too real threat to human health. I hope that this Conference helps meet the challenge, not only from the formal presentations, but also from the opportunity to exchange ideas face-to-face with your scientific colleagues from around the world.





# **Fred B. Kilmer – Infection Control Pioneer**

Robert F. Morrissey, Ph.D.

*Johnson & Johnson, U.S.A.*

# Introduction

Fred Kilmer was a man of the times, and the time was the late nineteenth century when America was undergoing a dramatic technological revolution. Scientific curiosity was his driving force. So too was his desire to serve mankind, to achieve pragmatic objectives. While his ability, skill, perseverance, and strength were apparent in many diverse fields of activity, most striking was his capacity to constantly look forward. He was a student of history, yet the future claimed his interest.

His appearance and demeanor, however, gave no hint of the determination that constantly churned within him. "Doc" Kilmer was mild mannered, frail in appearance, with a thin, elongated face accentuated by a goatee tapered to a point; he had the look of perpetual melancholy. Actually, Kilmer had an engaging personality, in addition to being a very astute pharmacist. The year was 1886, and Kilmer was serving as President of the New Jersey Pharmaceutical Association.

Kilmer was proprietor of the Opera House Pharmacy in New Brunswick, New Jersey, just down the street from a new company formed by the Johnson brothers. The Opera House Pharmacy had become a popular place, dispensing not only the medicaments of the day but indulging in the latest fads such as fizzled soda water. Kilmer had been there since 1879, having received his training at the New York College of Pharmacy and apprenticing in several states before settling in New Jersey.

A frequent customer at the pharmacy was Thomas Alva Edison, who bought supplies to use in his laboratories at Menlo Park some five miles away. Kilmer sold Edison some of the carbon he used in developing the first practical incandescent lamp. On his visits, Edison would go behind the prescription counter to watch Kilmer perform percolation and distillation and the other functions of pharmacy. Kilmer recalled, "At my suggestion he purchased a *U.S. Dispensatory* in order to become acquainted with the names of certain drugs and chemicals".

Over time, Kilmer and Edison became fast friends, sharing an interest in many areas of scientific research. Kilmer, through his training as a pharmacist, developed a probing curiosity and considerable knowledge about the cultivation of plants for medicinal purposes. In the display window of his drugstore, he assembled a map showing where certain plants were grown and describing how they were used in medicine. Edison was intrigued by the display and would spend long periods at the window of the Opera House Pharmacy studying Kilmer's elaborate work.

# Collaboration with Robert Wood Johnson

As he strolled up the avenue, another individual took an interest in Kilmer's display. He was a tall, stout man, with black hair and a generous mustache. He had large, deep brown eyes that seemed to rivet his subjects in place during discussions. His name was Robert Wood Johnson. He stopped at the pharmacy and met its proprietor.

This chance meeting brought together two markedly different individuals who were destined to become bound together for the rest of their lives by their deep convictions about the need to improve health care.

In one of his many visits to Kilmer's pharmacy, Johnson began discussing the teachings of Lister. Kilmer, too, was a believer, and lamented the fact that more physicians weren't practicing the basic rules of asepsis. Despite the magnitude of Lister's findings, only a handful of physicians in this country were aware of the discovery.

Out of their discussions came the realization that one of the greatest changes in the world of surgery was about to take place. Their basic premise was that all antiseptic dressings should be as ready for surgery as the surgeon himself. Such dressings should be assembled and packaged for shipment to the remotest areas and still remain free from contamination. Furthermore, the envisioned antiseptic dressings were to be constructed of a newly developed absorbent white cotton and gauze and designed in such a manner that their easy application would be readily apparent.

Together Kilmer and Johnson devised a plan. Kilmer would begin corresponding with a group of well-known American physicians and surgeons who were sympathetic to Lister, and would learn more about their experiences with what was known at the time as 'Listerism'. Meanwhile, Johnson and his associates would concentrate on improving surgical dressings so they would be available when there was a greater demand for them.

By 1887 Kilmer had gathered the views of many in the medical profession and compiled a monograph, which Johnson & Johnson printed in a booklet titled: *Modern Methods of Antiseptic Wound Treatment*. In many respects it was a 'how to' manual, and soon it was being proclaimed as the most authoritative treatise ever presented on the subject. The demand for it was astonishing, and within months 85,000 copies were in distribution.



# First Scientific Director, Johnson & Johnson

Recognizing Kilmer's many skills, Johnson wisely asked him to join the Company as Director of the Scientific Department. Kilmer pondered the decision for some time because of his dedication to pharmacy, but seeing the opportunity to play a larger role in health care and to have an influence on the direction of medical science, in 1889 he accepted.

The demand for *Modern Methods of Antiseptic Wound Treatment* continued unabated, and in time over four million copies were in distribution all over the world. This monograph, along with the introduction of moist antiseptic dressings in 1887 by Johnson & Johnson, marked the real beginning of antiseptic surgery in the United States.

During his early years at the Company, Kilmer had the opportunity to put into practice his revolutionary ideas of production hygiene. Cleanliness quickly became a religion in Johnson & Johnson. The new buildings constructed for the manufacture of surgical dressings were described by Kilmer as follows:

"The buildings set apart for this work were built for this special purpose — made plain and tight to exclude dirt. They are admirably situated away from busy and dusty streets. For miles on either side stretches river and meadow-land securing an almost dustless atmosphere."

Special attention was given to the grounds and the streets which were sprinkled and swept regularly. Inside the buildings, even more scrupulous attention was given to cleanliness. In areas adjoining the manufacturing areas, corners were painted white; even in the stairways where the tread and riser met the wall, the corner was painted white.

Kilmer described the dressings manufacturing areas in the following words:

"In fitting up the rooms in which the manipulations take place, the ideas kept in view were the exclusion of bacteria, easiness of keeping clean. The walls and ceilings are glass-smooth. The floors are filled and polished. There are no closets or shelving, no cracks or crevices to harbor dirt. The furniture consists of glass-topped tables with iron frames, allowing effectual and easy cleaning. The principal part of the work is done in the 'aseptic room', so called because all things within it are at all times kept surgically clean."

Everything was disinfected prior to entering the 'aseptic room'. The entrance to the aseptic room was through an anteroom where operators donned washable garments and proceeded to scrub their hands, face, and forearms in a solution of ammonia and soap. They rinsed in clean hot water and dried with a sterilized towel. Following this preliminary washing, persons passed immediately into the aseptic room. Once inside the room, those operators directly involved in handling the dressings were to further put on sterilized over-dresses, caps, sleeves, etc. The operators were supervised by graduate surgical nurses.

It is a curious fact that in the 1890s the employees of Johnson & Johnson preparing and packaging surgical dressings wore sterilized uniforms while many surgeons were operating in frock coats under conditions far short of surgical cleanliness.

In the dividing wall between the anteroom and the aseptic room was a sterilizer. It was rectangular in shape with doors at each end, one in the anteroom and the other in the aseptic room, and large enough to accommodate a wagon load of materials. The unit operated with saturated steam under pressure. This unit constitutes the first industrial steam sterilizer in the United States, if not the world. This sterilization technique was also used to treat dressing and packaging components before final preparation. This effectively reduced the bioburden and kept the aseptic room in a state of control.

In 1891 Kilmer established a bacteriological laboratory and repeated with great care the classical laboratory experiments of 1880 and 1881 conducted by Robert Koch and his associates in demonstrating the efficacy of hot air and steam in killing microorganisms. From these experiments, Kilmer developed a procedure for verifying an industrial sterilization process. He adopted as the reference organism, spores of *Bacillus anthracis*, an organism also favored by Koch. Kilmer took spores directly from nutrient medium to inoculate a portion of the dressing material. He cautioned, however, that the test material be wrapped in the center of the package and care be taken that this package passed through the same conditions as would the other dressings in the sterilizer load. The ability of the sterilization cycle to kill the test organisms under these conditions provided Kilmer with assurance that the other dressings in the load were also sterile. Thus was born the biological indicator in industrial sterilization.

Kilmer noted, however, that this procedure was particularly applicable to dressings which did not contain antiseptics and cautioned against its indiscriminate use with antiseptic dressings. He explained the phenomenon of bacteriostasis and described how this could be overcome by dilution. He recognized that a marginal sterilization process which affords relatively low assurance of sterility may require prolonged incubation to detect growth of surviving organisms. This concept of using reference indicator microorganisms in assuring sterility was extended to all sterile products. Training manuals were prepared to cover all aspects of manufacturing, and courses on the principles of asepsis were instituted for all employees.

When word reached Lister about the new methods of manufacturing and sterilizing surgical dressings, he wrote asking for details. On December 28, 1891, Kilmer sent a lengthy response outlining every step of the process. The inquiry generated a swell of pride among the employees of Johnson & Johnson. The man who discovered the techniques of sterile surgery was now interested in the future advances they had made. Soon production was soaring and the work force was constantly increasing in number.

Commenting on how far they had come, Kilmer wrote:

“Chemical sterilization and mechanical cleanliness are among the newer weapons that have been called to the aid of surgery. Antiseptic dressings have been made surgically clean. Antisepsis has not been abandoned, but has developed into its higher form: asepsis, and antiseptic processes have become aseptic.”

In an effort to disseminate this concept, he published in 1897 his classic paper entitled *Modern Surgical Dressings*. At this time he also instituted a company publication named *Red Cross Notes*. This periodical not only reported on developments in surgery, but

contained articles by leading surgeons. It soon became a national forum for all types of articles and comments on developments in medicine, both good and bad. Also contained in this periodical were descriptions of the manufacturing processes and procedures for testing its products, with illustrations of the facilities and selected products.

*Red Cross Notes* carried the latest bulletins on the most threatening contagious diseases: diphtheria, smallpox, typhoid, influenza, whooping cough, and tuberculosis. It promoted Company products discretely, and no one seemed to mind because it retained its scientific integrity. "It is a matter of pride that we retain the humble attitude of the sincere student," Kilmer wrote, "and we therefore earnestly solicit correspondence." Letters from physicians came in endless waves, relating their hopes and concerns about patient care. *Red Cross Notes* was edited by Kilmer until 1928.

Once the mystery of patient infection was solved, attention was focused on all of its possible causes. None was of greater concern than the suture material used to close wounds and incisions. Selecting the right material for sutures was critical, for it had to be strong and readily absorbed by the body. In 1865 Lister tried using ordinary musical instrument strings made from sheep intestines. They worked, though ironically Lister had to settle for inferior quality because all of the best strings were saved for use in musical instruments. The material was known as 'catgut,' and making it sterile was exceedingly difficult. The more the catgut was treated the greater danger there was that its natural properties would be destroyed. Catgut sutures were among Johnson & Johnson's earliest products. With them began an endless effort to improve suture quality and the complex immersion methods used in sterilization.

In the late afternoon of September 5, 1901 while attending the Pan Am Exposition in Buffalo, New York, President McKinley was shot through the stomach. Physicians decided to operate immediately in a vain attempt to save the President's life but he died a week later. McKinley's medical case became the topic of nationwide discussion. Could the life of the popular President have been saved? In the next issue of *Red Cross Notes*, Kilmer presented a detailed clinical explanation of the McKinley case, complete with anatomical diagrams. It was an attempt to use the famous case to instruct physicians on how to deal with bullet wounds of this gravity. The autopsy had already exonerated the medical team, but it was felt that a wider knowledge of the case would aid in the future treatment of abdominal wounds of this type. In the article Kilmer presented extensive excerpts from the official records, then added philosophically: "...though nations come and go, republics flourish or wither, rulers pass away, the healing art moves on, and the surgeons will turn from the keen disappointment as to the outcome of this illustrious case to a study of the scientific aspects."

# Kilmer's Role in First Aid

As industry expanded and production machinery became more complex, accident rates climbed rapidly. Information about first aid was needed and Kilmer prepared a series of bulletins. In one of the bulletins Kilmer defined first aid as “a bridge between the accident and medical and surgical assistance, over which the patient may be carried safely and securely from the scene of the accident or sudden illness to the doctor or hospital...” In 1901 the Company published the first complete book ever written on the subject, *Johnson's First Aid Manual*. It dealt with the simplest, most effective methods for the layperson to treat the injured in an emergency, while keeping in mind the caution that the ultimate fate of the injured person often depended on the actions of the first person to apply first aid. The right technique could be most helpful, while the wrong action could be fatal. Each recommended step was carefully illustrated to avoid errors, and as Kilmer noted in his introduction, “Extensiveness has in all cases been sacrificed to simplicity.”

The manual was an immediate success. Soon it was adopted by thousands of first aid training programs as the ‘official’ guide. Equally important, the book helped to focus attention on the improvement of first aid techniques. As a result, when the eighth edition of the guide went to press a decade later, there were contributions from 65 physicians, each of them dealing with a different and often new aspect of first aid. A leading medical journal, *American Medicine*, hailed the manual as the most complete book of its kind, and gave an added compliment to the Company for never having attempted “to give instruction in surgery.” The manual gained worldwide popularity on its own and went through 11 editions by 1932 when Kilmer ceased editing it.

Kilmer was not only a distinguished scientist but also a talented writer. He published widely in both professional and trade journals. There were papers on the cultivation of medicinal plants, pharmacopoeial analysis, sanitation, pharmaceutical professionalism and education, practical pharmacy, and history of pharmacy. In addition, until 1925 he was also in charge of all legal correspondence for Johnson & Johnson, including patents, trademarks, and litigations. In 1929 Kilmer organized a museum of surgical products with the “main and most important object” being the “protection of trademarks, copyrights, and patents”.



# Kilmer's Role in Public Health

Accidents and the need for first aid were not the only challenge for the American public. When a commission appointed to investigate the methods of food preparation verified the most shocking revelations, President Theodore Roosevelt and Congress were prodded into action. Roosevelt appointed Harvey W. Wiley, a strong proponent of the reforms, to administer the Pure Food and Drugs Act once it was put in workable form. This called for an evaluation of the right controls, and Kilmer's expert advice was promptly sought since he was a recognized authority in the field of public health.

Johnson & Johnson was assigned 'No. 117 — Guaranteed Under the Food and Drugs Act,' which, signed by Johnson himself, gave assurance that these products were not adulterated or misbranded. Passage of the new Pure Food and Drug Act was described by Fred Kilmer as "a marvelous revolution in the statements made by the proprietors of 'patent' or proprietary remedies and 'quack' medicines." The new law came as a jolt to some firms, and many questionable products soon disappeared from the market.

When tested, every product produced by Johnson & Johnson turned out to be in full conformity with the law and no changes in production methods or standards were required. At the request of the government, the Company made available to the Department of Agriculture, which had responsibility for the analysis of products, all of the testing procedures and techniques that had been developed in its laboratories over the years.

Kilmer had always seen his and the Company's mission in health care as extending beyond products. He described that larger role quite eloquently:

"The department is not conducted in a narrow, commercial spirit, but is constantly engaged in purely scientific inquiry, and not kept going for the purpose of paying dividends or solely for the benefit of Johnson & Johnson, but a view to aiding the progress of the art of healing."

Beyond the immediate impact that the new Act had on public health was its influence in bringing about improvements in state and local laws. Almost immediately there was increased pressure on government authorities to rectify some of the serious health conditions of the time, including the chlorination of water, inspection of milk, control of flies and mosquitoes, and regulations to decrease the spread of diphtheria and tuberculosis. Many of these measures, including the relatively new practice of giving physical examinations to school children, were part of the program already initiated by Fred Kilmer in his service as President of the New Brunswick Board of Health and advisor to the New Jersey State Board of Health. What remained to be done, however, was to educate authorities on the wisdom of tightening health laws, and Kilmer and his associates went about the task vigorously. He later recalled their efforts to bring about health reforms:

"Our work was largely educational, but out of these crude and faulty methods came the great advances in hygiene and sanitation, including improvement in the water supply, increased sewage disposal, tuberculosis campaigns, care of babies, visiting nurse programs, and a whole host of measures calculated to improve the health of

our citizens.”

# World War I and *Red Cross Notes*

The modern warfare of World War I presented new challenges to even the most gifted physicians. The noted French surgeon, Dr. Alexis Carrel, was so appalled at the high rate of amputations among the wounded due to infection that he began developing a new antiseptic system that later involved Fred Kilmer. Carrel found that deep wounds, such as those inflicted by exploding shells, healed better if kept constantly irrigated with an antiseptic solution. He devised an apparatus to irrigate wounds that used a solution of ordinary bleaching lime, which was found to be unstable and risky. This problem was brought to Kilmer's attention and a new formula was developed using chloris-soda ampoules. When dropped in water they produced the right solution to properly irrigate the wound. The formula was made available to surgeons trying Carrel's new technique, and it proved highly successful. The special 'War Surgery' issue of *Red Cross Notes* examined all aspects of the complicated procedure.

Even in normal times Kilmer was a prodigious worker who could be found in his laboratories long into the night. During the war, however, he pushed himself mercilessly. "It is this way," he explained, "if there are one million men under arms at the front, that means that hospital supplies for twice that number must be ready."

A father figure to many of the younger employees, Kilmer began corresponding with a number of the men and women who went into service by sending them notes of encouragement. In addition, he would print accounts of their experiences in Company publications. Kilmer's own son, Joyce, the talented writer and poet, had enlisted in the Army and was serving on a battlefield in France. Joyce Kilmer's most famous poem, 'Trees', was supposedly inspired by a spreading white oak tree that grew in New Brunswick.

In 1918, Joyce Kilmer, now a sergeant in the intelligence section, volunteered to replace the aide to Major Donovan of the 'Fighting 69th'. He greatly admired Donovan's bold leadership, and on the morning of July 30th accompanied him on a scouting mission. The two separated for a short time, and when the major returned he found that Kilmer had been killed by enemy fire. Annie Kilmer had now lost their fourth and last child. She had previously lost a son and daughter in infancy. Another son died as a suicide at 26 and Joyce was killed before his 32<sup>nd</sup> birthday. Fred Kilmer's writings never reflected the tragic aspects of his family life.

Strangely, the name of Kilmer has been perpetuated not because he was a distinguished scientist and talented writer, but because of his son, Alfred Joyce Kilmer. Annie Kilmer devoted the remainder of her life to perpetuating Joyce's memory by setting many of his poems to music. In addition, there is a U.S. Army Camp Kilmer; there are dozens of American Legion Posts throughout the United States named Joyce Kilmer Posts; there was a Liberty Ship in World War II named Joyce Kilmer; and there are Joyce Kilmer streets, parks, trees, and forests. This is not to say that Fred B. Kilmer was not recognized. During his lifetime he was recognized as a respected writer on scientific and medical subjects, acknowledged for his wisdom and almost prophetic understanding of the future.

# Conclusion

Until a few weeks before his death in 1934, at the age of 83, Fred Kilmer visited the Company almost every day. Johnson & Johnson had been the focal point of his life for 45 years, and by his own choice, he never retired. He came and went as he pleased, stopping in at the research laboratories or spending long hours in the archives he had set up to trace the history of the Company's trademarks and product development. Upon his death, *American Druggist* magazine described Kilmer as "...one of the most fascinating individuals American Pharmacy has given to the world." *Time* magazine described him as "the most revered pharmaceutical chemist in the country". Perhaps the most fitting tribute to his contributions to the world were expressed by the editor of the New Jersey Pharmaceutical Association's *Journal of Pharmacy* that described him as "one of the most talented and discerning writers in the pharmaceutical field".



# General References

1. Gaughran ERL. Fred B. Kilmer - pioneer in microbiological control. In: Gaughran ERL, Kereluk K, editors. Sterilization of Medical Products, Volume 1. Montreal: Multiscience Publications; 1977. pp. 1-16.
2. Foster LG, editor. Johnson & Johnson. One Hundred Year Illustrated History of Johnson & Johnson. New Brunswick (NJ): Johnson & Johnson; 1986.



# KEYNOTE ADDRESS

## Infectious Disease as an Evolutionary Paradigm<sup>1</sup>

Joshua Lederberg, Ph.D.

*Sackler Foundation Scholar, The Rockefeller University, U.S.A.*

The basic principles of genetics and evolution apply equally to human hosts and to emerging infections, in which foodborne outbreaks play an important and growing role. However, we are dealing with a very complicated coevolutionary process in which infectious agent outcomes range from mutual annihilation to mutual integration and resynthesis of a new species. In our race against microbial evolution, new molecular biology tools will help us study the past; education and a global public health perspective will help us deal better with the future.

Life expectancy in the United States from 1900 to the present (Figure 1) shows an overall steady rise, reflecting improved health conditions in general, the result of advances in medical science, hygiene, personal care, health technologies, and public health administrations. The rise decelerates asymptotically to a near plateau from the 1950s to the 1970s, reflecting an epidemic of coronary disease, which we do not yet fully understand. Improvements in medical care, attention to life style, or indiscriminate use of aspirin may all be responsible for the subsequent decrease in deaths from coronary disease. Up to the 1940s, the rising curve is jagged, reflecting sporadic infectious disease outbreaks, especially the Spanish influenza outbreak of 1918. Whether the life expectancy curve continues to rise smoothly or whether it has some jagged declines depends on what we do about transmission of infectious disease, including foodborne disease. When plotted another way (Figure 2), both the absolute number of deaths from infectious disease and the proportion of total deaths attributable to infectious disease also show steady amelioration from 1900 almost to the present.

The 1918 Spanish influenza pandemic may be a prototype for future emerging infections. Although minimized as not much more than a bad cold, influenza took a terrible toll in 1918, especially on young people (Figure 3). Somewhat older persons may have been protected by immunity from prior exposure to related strains of influenza. The disease, with rapid onset of fulminating pneumonic symptoms, killed 20 to 25 million persons worldwide. The infectious agent was not available for study at that time. However, very recently the Armed Forces Institute of Pathology recovered with PCR technology genetic fragments of the 1918 influenza virus [1]. Less than 10% of the entire genome has been recovered to date, but recovery of complete sequences is likely. Although the target genes have not yet provided a clue as to why the 1918 influenza was so devastating, they demonstrate the enormous potential of today's molecular biology tools.

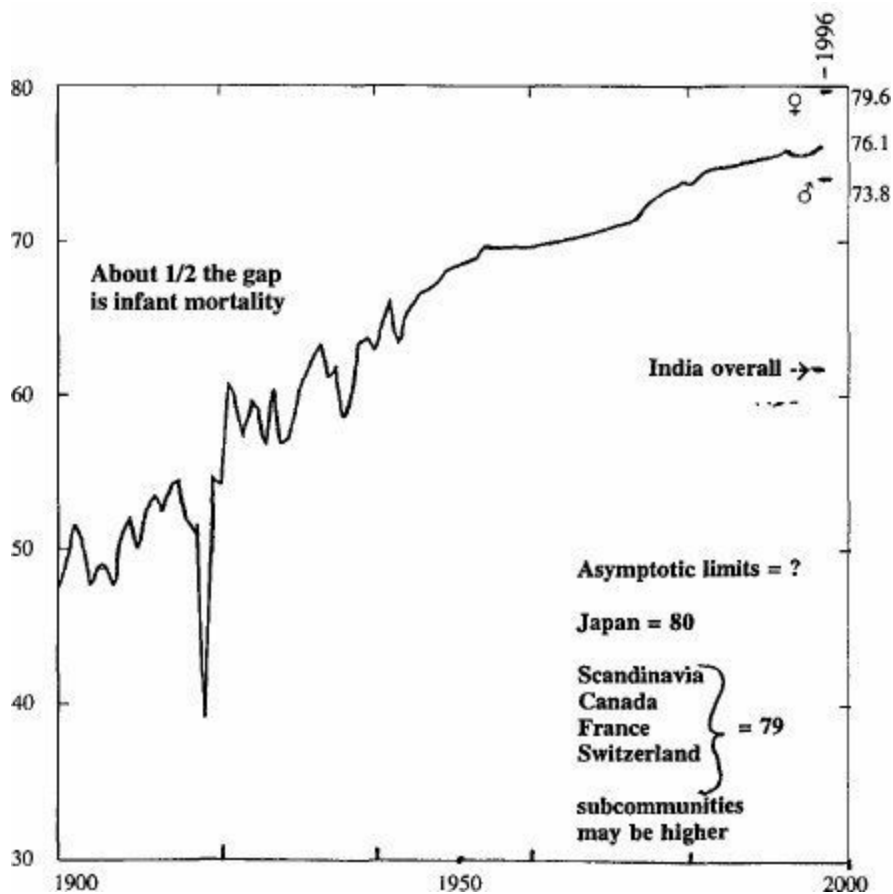

**Figure 1.** Life expectancy in the United States, at birth, 20th century.

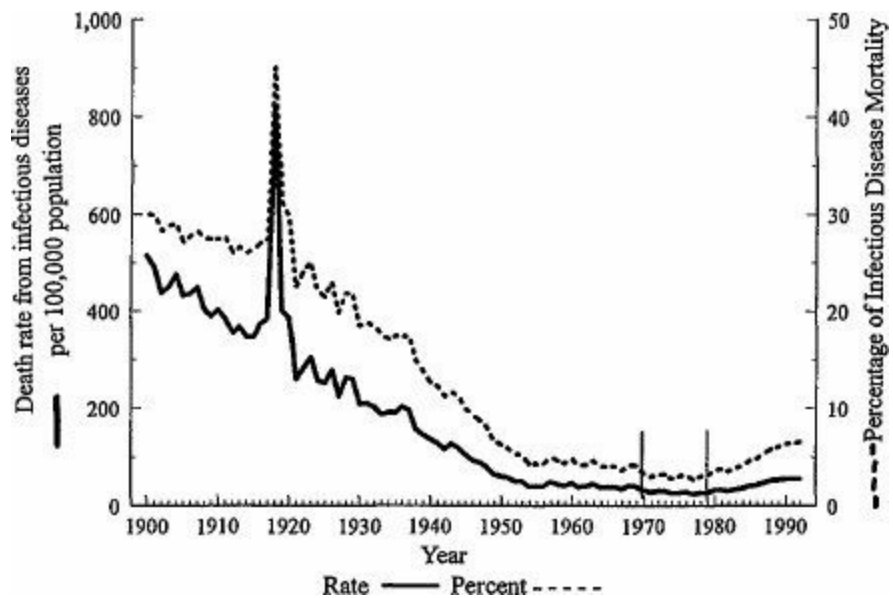

**Figure 2.** Trends in infectious diseases mortality, 1900-1992. Source: CDC, unpublished data.

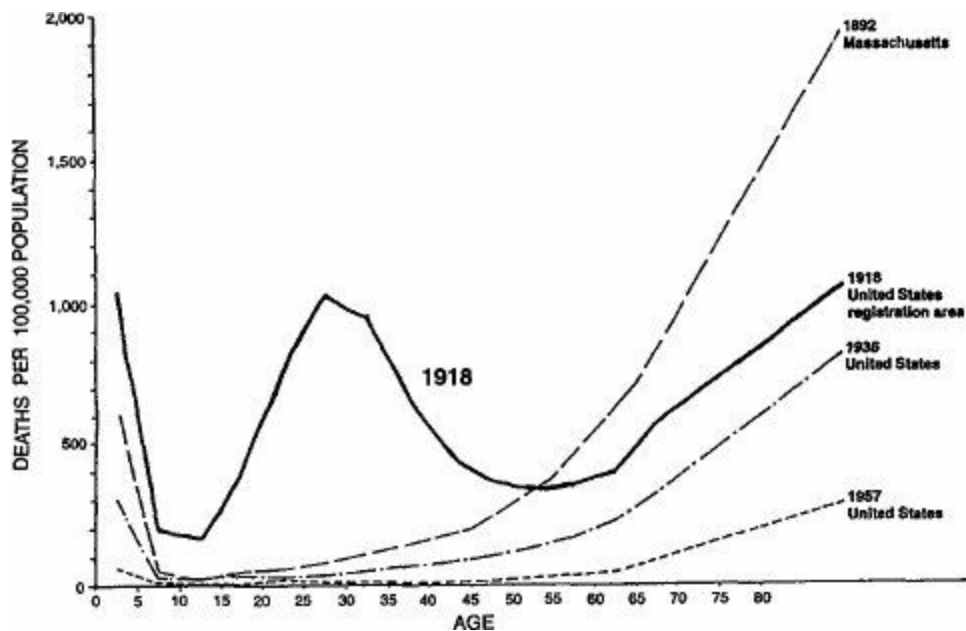

**Figure 3.** Pneumonia and influenza mortality, by age, in certain epidemic years. (Reprinted with permission of W. Paul Glezen and Epidemiologic Reviews. *Emerging Infections: Pandemic Influenza*. *Epi Rev* 1996;18:66).

These tools will enable us to better study paleovirology and paleomicrobiology. We are accustomed to stereotyping historical disease outbreaks as if we really knew what they were, but we really know very little detail about their genetic features. For example, we talk about the great historic plagues as if they indeed were *Yersinia* or cholera or malaria. We should look forward to finding out about the 14th century black death, if it was indeed *Yersinia pestis*. Although clinically unmistakable, that is not to say it was caused by the identical genotype of present *Yersinia* strains.

We need to look ahead as well as back. In this century, emerging and reemerging infections have stimulated flurries of interest, but in general we have been complacent about infectious diseases ever since the introduction of antibiotics. The effect of antibiotics on acute infections and tuberculosis as well as the effect of polio vaccination led to a national, almost worldwide, redirection of attention to chronic and constitutional diseases. However, the HIV pandemic in the early 1980s caught us off guard, reminding us that there are many more infectious agents in the world. It is fortuitous that retroviruses had already been studied from the perspective of cancer etiology; otherwise, we would have had no scientific platform whatsoever for coping with HIV and AIDS.

The Committee on International Science Engineering and Technology provided an interagency review setting out a policy framework for the United States' global response to infectious disease (Table 1). The policy provides a worldwide mantle for surveillance and monitoring, remedial measures, development of new drugs, vaccines, and treatment modalities. The global outlook is necessary, even if for purely selfish reasons, because to infectious agents the world is indivisible, with no national boundaries. Our thinking has been impoverished in terms of budget allocations for dealing with health on an international basis.

We are engaged in a type of race, enmeshing our ecologic circumstances with evolutionary changes in our predatory competitors. To our advantage, we have wonderful

new technology; we have rising life expectancy curves. To our disadvantage, we have crowding; we have social, political, economic, and hygienic stratification. We have crowded together a hotbed of opportunity for infectious agents to spread over a significant part of the population. Affluent and mobile people are ready, willing, and able to carry afflictions all over the world within 24 hours' notice. This condensation, stratification, and mobility is unique, defining us as a very different species from what we were 100 years ago. We are enabled by a different set of technologies. But despite many potential defenses — vaccines, antibiotics, diagnostic tools — we are intrinsically more vulnerable than before, at least in terms of pandemic and communicable diseases.

We could imaginably adapt in a Darwinian fashion, but the odds are stacked against us. We cannot compete with microorganisms whose populations are measured in exponents of  $10^{12}$ ,  $10^{14}$ ,  $10^{16}$  over periods of days. Darwinian natural selection has led to the evolution of our species but at a terrible cost. If we were to rely strictly on biologic selection to respond to the selective factors of infectious disease, the population would fluctuate from billions down to perhaps millions before slowly rising again. Therefore, our evolutionary capability may be dismissed as almost totally inconsequential. In the race against microbial genes, our best weapon is our wits, not natural selection on our genes.

New mechanisms of genetic plasticity of one microbespecies or another are uncovered almost daily. Spontaneous mutation is just the beginning. We are also dealing with very large populations, living in a sea of mutagenic influences (e.g., sunlight). Haploid microbes can immediately express their genetic variations. They have a wide range of repair mechanisms, themselves subject to genetic control. Some strains are highly mutable by not repairing their DNA; others are relatively more stable. They are extraordinarily flexible in responding to environmental stresses (e.g., pathogens' responses to antibodies, saprophytes' responses to new environments).

Mechanisms proliferate whereby bacteria and viruses exchange genetic material quite promiscuously. Plasmids now spread throughout the microbial world [3]. They can cross the boundaries of yeast and bacteria. Lateral transfer is very important in the evolution of microorganisms. Their pathogenicity, their toxicity, their antibiotic resistance do not rely exclusively on evolution within a single clonal proliferation.

**Table 1. Examples of Pathogenic Microbes and Infectious Diseases Recognized Since 1973 [2]**

Year	Microbe	Type	Disease
1973	Rotavirus	Virus	Major cause of infantile diarrhea worldwide
1975	Parvovirus B19	Virus	Aplastic crisis in chronic hemolytic anemia
1976	<i>Cryptosporidium</i>	Parasite	Acute and chronic diarrhea parvum
1977	Ebola virus	Virus	Ebola hemorrhagic fever
1977	<i>Legionella</i>	Bacteria	Legionnaire's disease pneumophila

1977 Hantaan virus	Virus	Hemorrhagic fever with renal syndrome (HRFS)
1977 <i>Campylobacter jejuni</i>	Bacteria	Enteric pathogens distributed globally
1980 Human T-lymphotropic virus I (HTLV-1)	Virus	T-cell lymphoma-leukemia
1981 Toxic producing strains of <i>Staphylococcus aureus</i>	Bacteria	Toxic shock syndrome (tampon use)
1982 <i>Escherichia coli</i> O157:H7	Bacteria	Hemorrhagic colitis; hemolytic uremic syndrome
1982 HTLV-II	Virus	Hairy cell leukemia
1982 <i>Borrelia burgdorferi</i>	Bacteria	Lyme disease
1983 Human immunodeficiency virus (HIV)	Virus	Acquired immunodeficiency syndrome (AIDS)
1983 <i>Helicobacter pylori</i>	Bacteria	Peptic ulcer disease
1985 <i>Enterocytozoon bieneusi</i>	Parasite	Persistent diarrhea
1986 <i>Cyclospora cayetanensis</i>	Parasite	Persistent diarrhea
1988 Human herpes-virus-6 (HHV-6)	Virus	Roseola subitum
1988 Hepatitis E	Virus	Enterically transmitted non-A, non-B hepatitis
1989 <i>Ehrlichia chafeensis</i>	Bacteria	Human ehrlichiosis
1989 Hepatitis C	Virus	Parenterally transmitted non-A, non-B liver infection
1991 Guanarito virus	Virus	Venezuelan hemorrhagic fever
1991 <i>Encephalitozoon hellem</i>	Parasite	Conjunctivitis, disseminated disease
1991 New species of <i>Babesia</i>	Parasite	Atypical babesiosis
1992 <i>Vibrio cholerae</i> O139	Bacteria	New strain associated with epidemic cholera
1992 <i>Bartonella henselae</i>	Bacteria	Cat-scratch disease; bacillary angiomatosis
1993 Sin Nombre virus	Virus	Adult respiratory distress syndrome
1993 <i>Encephalitozoon cuniculi</i>	Parasite	Disseminated disease
1994 Sabia virus	Virus	Brazilian hemorrhagic fever
1995 HHV-8	Virus	Associated with Kaposi sarcoma in AIDS patients

We have a very powerful theoretical basis whereby the application of selective pressure (e.g., antibiotics in food animals) will result in drug resistance carried by plasmids, or pathogens attacking humans. It is not easy to get direct and immediate epidemiologic evidence, but the foundations for these phenomena exist and must be taken into account in the development of policies. We have barely begun to study the responses of microorganisms under stress, although we have examples where root mechanisms of adaptive mutability are themselves responses to stress. In recent experiments, bacterial



restriction systems are more permissive of the introduction of foreign DNA, possibly letting down their guard in response to “mutate or die” circumstances. This does not reflect bacterial intelligence — that they know exactly what mutations they should undergo in response to environmental situations. Their intrinsic mutability and capacity to exchange genetic information without knowing what it is going to be is not a constant; it is certainly under genetic control and in some circumstances varies with the stress under which the microbes are placed.

Evolution is more or less proportionate to the degree of genetic divergence among the different branches of the three-tiered tree of life, with the archaeal branch, the eubacterial branch, and the eukaryotes (Figure 4). The tree illustrates the small territory occupied by humans in the overall world of biodiversity. It shows mitochondria right next to *Escherichia coli*. Bacterial invasion of a primitive eukaryote 2-1/2 to 3 billion years ago, synchronized with the development of primitive green oxygen-generating plants, conferred a selective advantage to complexes that could use oxygen in respiration. Our ancestors were once invaded by an oxidative-capable bacterium that we now call a mitochondrion and that is present in every cell of every body and almost every species of eukaryote. We did not evolve in a monotonous treelike development; we are also the resynthesis of components of genetic development that diverged as far as the bacteria and were reincorporated into the mitochondrial part of our overall genome. Another example of lateral transfer is the symbiosis that resulted from chloroplast invasion of green plants.

The outcome of encounters between mutually antagonistic organisms is intrinsically unpredictable. The 1918 influenza outbreak killed half percent of the human population; but because the consequences were to either kill the host or leave the host immune, the virus died out totally, leaving no trace in our genomes, as far as we know. Historic serology on survivors has found memory cells and antibodies against H1N1, the serotype of the resurrected 1918 virus. Unlike the influenza virus, which left no known genetic imprint, 400 to 500 retroviruses are integrated into our human genome. The full phylogeny of these encounters is unknown, but many of these viruses may precede the separation of homo sapiens from the rest of the hominid line.

Infectious agent outcomes range from mutual annihilation to mutual integration and resynthesis of a new species. Much has been made of the fact that zoonoses are often more lethal to humans than to their original host, but this phenomenon cannot necessarily be generalized. Most zoonoses do not affect humans adversely. Some are equally capable in a new host. We tend to pay most attention, however, to those, such as yellow fever, for which we have not genetically or serologically adapted and which cause severe disease.

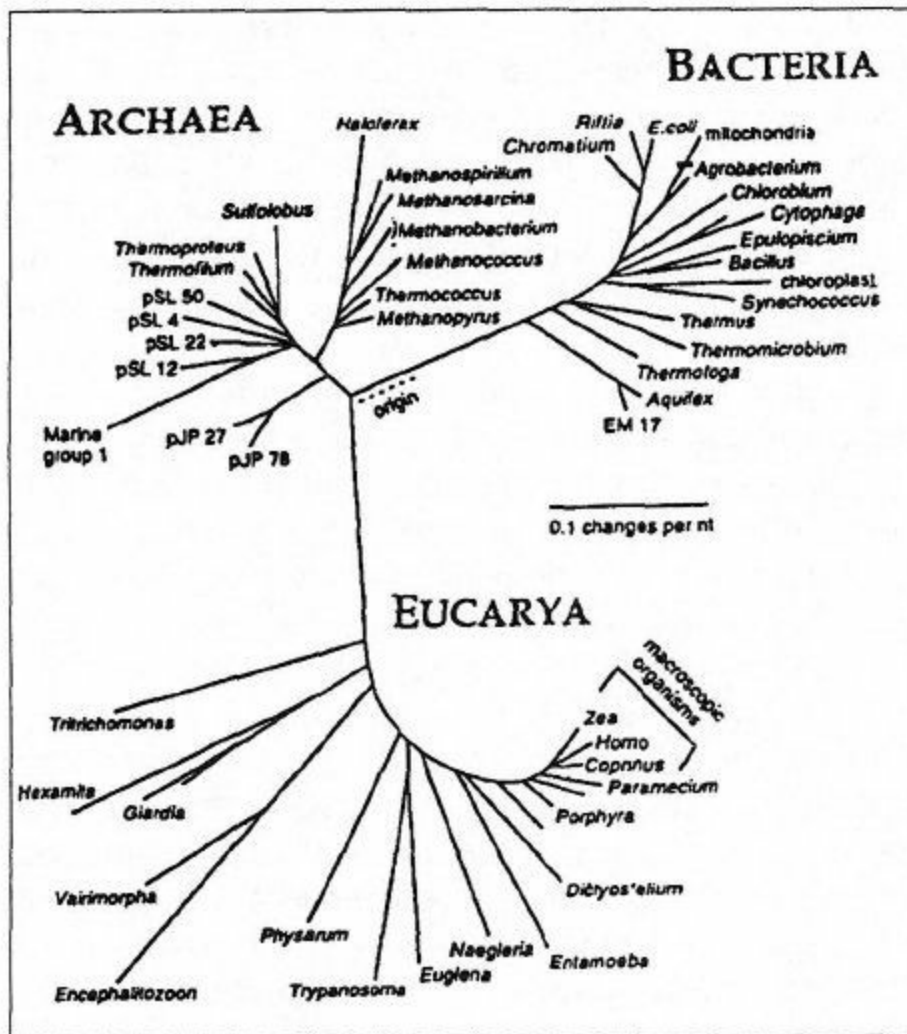

**Figure 4.** The three-domain tree of life based on small-subunit rRNA sequences. Reprinted with permission of Norman R. Pace and ASM News. ASM News 1996;62(9):464.

Canine distemper provides an example of a quasihereditary adaptation. In the Serengeti, the disease migrated from village dogs to jackals, which shared prey and had contact with lions. About one-fourth of the preserve's 4,000 lions died of canine distemper [4] but the survivors are immune and will pass immunoglobulin to their offspring. The cubs' maternal immunity will likely mitigate infection and permit a new equilibrium, not because of genetic adaptation but because of the preimmunized host. This is also the most plausible explanation for how savage the polio virus has been as a paralytic infection of young people. It may also apply to hepatitis, where cleaner is not always better if it means we do not have the "street smarts" to respond to new infectious challenges. These nongenetic adaptations between parasite and host complicate our outcome expectations.

Short-term shifts in equilibrium can give ferocious but temporary advantages to a virus. Long-term outcomes are most stable when they involve some degree of mutual accommodation, with both surviving longer. New short-term deviants, however, can disrupt this equilibrium. The final outcome of the HIV pandemic cannot be predicted. More strains with longer latency may be taking over, mitigating the disease. However, deviant strains

could counteract this effect by overcoming immunity and rapidly proliferating, with earlier and more lethal consequences.

We should also consider somatic evolution, a Darwinian process that occurs with every infection. In the clonal selection model of immunogenesis [5], an apparently random production of immunoglobulin variants, both by reassortment of parts and by localized mutagenesis, gives rise to candidate antibodies, which then proliferate in response to matching epitopes. We do not understand the details of how a given epitope enhances stepwise improvements in affinity and productivity of antibodies at various stages. The process may be more complicated than we realize; so may Darwinian evolution.

Despite the prior arguments against relying on host or genotype evolution as a response to infection, historically we have done so and now have “scars of experience.” A notable example is malaria, wherein the Duffy mutation against *Plasmodium vivax* is the only host defense with no deleterious consequences. The thalasseмии, G6PD deficiency, and hemoglobin S are all hemopoietic modifications that thwart the plasmodia; but in homozygotes, they themselves cause disease. In the evolution of our species, for every child spared an early death because a hemoglobin S mutation impeded *Plasmodium* development, another will succumb to sickle cell disease unless we can intervene. Specific remedies do not exist. Although somatic gene therapy is an interesting possibility, one that will probably progress in the next 20 years, it is paradoxical that we know more about hemoglobin S than any other molecular disease. The entire concept of genetic determination of protein structure has been based on these early observations, yet we are still searching with limited success for ways to put it to therapeutic use.

Biotechnology may enable other forms of genetic intervention through which homo sapiens could conceivably bypass natural selection and random variation. In the absence of alternatives, we might speculate about these kinds of “aversive therapies” as a last resort to save our species.

The ultimate origin of life is still the subject of many theories, as is the origin of viruses (Table 2). Each virus is different. We know nothing of virus phylogenies and cannot even substantiate the distinctions of the several hundred categories. We do not know their origin, only that they interact with host genomes in many ways. Particles could come out of any genome, become free-living (i.e., independent, autonomously replicating units in host cells), reenter a host genome as retroviruses and possibly others do, and repeat the cycle dozens of times. But no one can give a single example or claim to have significant knowledge of how any particular virus evolved, thus presenting a scientific challenge for the next 20 or 30 years.

We are dealing with more than just predation and competition. We are dealing with a very complicated coevolutionary process, involving merger, union, bifurcation, and reemergence of new species (Table 3). Divergent phenomena can occur in any binary association, with unpredictable outcomes. We have hundreds of retroviruses in our genome and no knowledge of how they got there. As to HIV, we have no evidence as yet that it has ever entered anyone’s germ line genome: we really do not know whether it ever enters germ cells. The outcomes of even that interaction could be much more complicated than the purely parasite/host relationships we are accustomed to.

## Table 2. The Origin of Viruses

---

Viruses are genomic fragments that can replicate only in the context of an intact living cell. They cannot therefore be primitive antecedents of cells.

Within a given species, viruses may have emerged as genetic fragments or reduced versions from chromosomes, plasmids, or RNA of

- 1) the host or related species
- 2) distant species
- 3) larger parasites of the same or different hosts
- 4) further evolution and genetic interchange among existing viruses

Once established, they may then cycle back into the genome of the host as an integrated episome; there they may have genetic functions or in principle might reemerge as new viruses.

These cycles have some substantiation in the world of bacterial viruses; but we have no clear data on the provenience of plant or animal viruses.

---

## Table 3. Genetic Evolution

---

Microbes (bacteria, viruses, fungi, protozoa)

Rapid and incessant

Huge population sizes  $10^{14}+$  and generation times in minutes vs. years

Intraclonal process

DNA replication — may be error-prone — in sea of mutagens sunlight; unshielded chemicals, including natural products

RNA replication — intrinsically unedited,  $>10^{-3}$  swarm species

Haploid: immediate manifestation, but partial recessives not accumulated contra multicopy plasmids

Amplification

Site-directed inversions and transpositions: phase variation

?? Other specifically evolved mechanisms: genome quadrant duplication; silencing

Interclonal process

Promiscuous recombination — not all mechanisms are known

Conjugation — dozens of species

Viral transduction and lysogenic integration: universal

Classical: phage-borne toxins in *C. diphtheriae*

Plasmid interchange (by any of above) and integration

Toxins of *B. anthracis*

Pasteur: heat attenuation: plasmid loss; chemically induced

RNA viral reassortment; ?? and recombination?

Transgressive—across all boundaries

Artificial gene splicing

Bacteria and viruses have picked up host genes (antigenic masking?)

Interkingdom: *P. tumefaciens* and plants, *E. coli* and yeast

Vegetable and mineral! oligonucleotides and yeast.

Host-parasite coevolution

Coadaptation to mutualism or accentuation of virulence?

Jury is still out (May and Anderson). Many zoonotic convergences.

Probably divergent phenomena, with short-term flareups and Pyrrhic victories, atop long-term trend to coadaptation.

---

Innovative technologies for dealing with microbial threats have the potential for fascinating therapeutic opportunities (Table 4). Some, like bacteriophage, have been set aside as laboratory curiosities. Nothing is more exciting than unraveling the details of pathogenesis. Having the full genomes of half a dozen parasitic organisms opens up new opportunities for therapeutic invention in ways that we could not have dreamed of even 5 years ago, which will lead to many more technologies. In food microbiology, we should keep in mind the probiotic as well as the adversarial and pathogenetic opportunities in our alimentary tracts.

#### **Table 4. Technologies to Address Microbial Threats**

---

Antibacterial chemotherapy

Potentially unlimited capability; bacterial metabolism and genetic structure notably different from human genome sequencing pointing to bacterial vulnerabilities

Economic-structural factors—public expectation for unachievable bargains in safety assurance, cost of development, and ultimate pricing

Dilemmas of regulation of (ab)use

Resurgent interest in bacteriophage and other biologically oriented approaches

Antiviral chemotherapy

Much more difficult program, inherently

Gross underinvestment

New approaches: antisense, ribozymes, targeted D/RNA cleavers

Problematics of sequence-selective targets

Vaccines

Gross underinvestment; other structural problems as above

Liability/indemnification

Vaccination as service to the herd

New approaches: hot biotechnology is coming along especially live attenuated: but testing dilemmas

Safety issues about use of human cells lines; adjuvants

Immunoglobulins and their progeny

Phage display and diversification: biosynthetic antibody

Passive immunization for therapy

Biologic response modifiers

New world of interleukins, cell growth factors so far just scratching surface  
Interaction with pathogenesis  
Intersection with somatic gene therapy

Technologies for diagnosis and monitoring  
Etiologic agents and control  
Host polymorphisms and sensitivities

Homely technologies needed  
Simple, effective face-masks  
Palatable water-disinfectants  
Home-use diagnostics of contamination

---

The Committee on International Science Engineering and Technology report [2] provides some recommendations (Table 5). We need a global perspective. We need to invest in public health, especially food microbiology, not just medical care, in dealing with disease. It is important to prevent foodborne disease through sensible monitoring, standards of cleanliness, and consumer and food-handler education and not just care for its victims.

**Table 5. CISET\* Recommendations for Addressing Global Infectious Disease Threats**

---

1. Concerted global and domestic surveillance and diagnosis of disease outbreaks and endemic occurrence. This must entail the installation of sophisticated laboratory capabilities at many centers now lacking them.
  2. Vector management and monitoring and enforcement of safe water and food supplies; and personal hygiene (e.g., Operation Clean Hands).
  3. Public and professional education.
  4. Scientific research on causes of disease, pathogenic mechanisms, bodily defenses, vaccines, and antibiotics.
  5. Cultivation of the technical fruits of such research, with the full involvement of the pharmaceutical industry and a public understanding of the regulatory and incentive structures needed to optimize the outcomes.
- 

\* Committee on International Science, Engineering and Technology Policy of the National Science and Technology Council.

Today we emphasize individual rights over community needs more than we did 50 to 75 years ago. Restraining the rights and freedoms of individuals is a far greater sin than allowing the infection of others. The restraints placed on Typhoid Mary might not be acceptable today, when some would prefer to give her unlimited rein to infect others, with litigation their only recourse. In the triumph of individual rights, the public health perspective has had an uphill struggle in recent pandemics.

Education, however, is a universally accepted countermeasure, especially important in foodborne diseases. Food safety programs should more specifically target food handlers,

examining their hands to determine if they are carriers, to ensure they are complying with basic sanitation.

We typically do this only after an outbreak. Perhaps we should have further debate on the social context for constraints and persuasion to contain the spread of infectious agents.



# References

1. Taubenberger JK, Reid AH, Frafft AE, Bijwaard KE, Fanning TG. Initial genetic characterization of the 1918 “Spanish” influenza virus. *Science* 1997;275:1793-6.
2. NSTC-CISET Working Group on Emerging and Reemerging Infectious Diseases. Infectious disease — a global health threat. Washington (DC): The Group;1996.
3. Lederberg J. Plasmid (1952-1997). *Plasmid*. 1998;39:1-9.
4. Roelke-Parker ME, Munson L, Packer C, et al. A canine distemper virus epidemic in Serengeti lions (*Panthera leo*). *Nature* 1996;379:441-5.
5. Lederberg J. The ontogeny of the clonal selection theory of antibody formation: reflections on Darwin and Ehrlich. *Ann N Y Acad Sci* 1988;546:175-87.

- 
1. Adapted with permission from a previously published article: Lederberg J. Infectious disease as an evolutionary paradigm. *Emerging Infectious Diseases* 1997;3(4):417-23.



# **Session I**

## **Emerging Infectious Diseases**

**Chairman: James M. Hughes, M.D.**

*Centers for Disease Control and Prevention, U.S.A.*



# A Global View of Emerging Infections and Antimicrobial Resistance

James M. Hughes, M.D.

*National Center for Infectious Diseases, Centers for Disease Control and Prevention,  
U.S.A.*

In 1962, Sir McFarland Burnet wrote, “One can think of the middle of the 20th century as the end of one of the most important social revolutions in history — the virtual elimination of the infectious disease as a significant factor in social life.” [3] We are currently paying the price for the complacency represented by this statement concerning infectious diseases.

Infectious diseases are the leading cause of death worldwide [15] and are also an important cause of mortality in the United States. Results of a recent analysis indicate that infectious diseases are the third leading cause of death in the United States when they are aggregated, ranking behind heart disease and cancer [12]. Between 1980 and 1992, a 58% increase in overall infectious disease mortality occurred. After age-adjustment, the increase was 39%. The major contributors were HIV infection and AIDS, acute respiratory disease (primarily pneumonia), and bloodstream infection.

Just over 5 years ago, the Institute of Medicine (IOM) published “Emerging Infections: Microbial Threats to Health in the United States” [9]. This report, which represents the work of a large group of experts led by Dr. Joshua Lederberg and Dr. Robert Shope, is important in several ways. The report defined the issue as “new, re-emerging, or drug-resistant infections whose incidence in humans has increased within the past two decades or whose incidence threatens to increase in the near future.” That definition is very broad. The report identified six factors that the committee felt contributed to disease emergence and re-emergence. These factors include changes in human demographics and behavior; advances in technology and industry; economic development and changes in land use patterns; the dramatic increases in international travel and commerce, microbial adaptation and change (microbial evolution) which make infectious diseases unique; and the breakdown of public health systems required to prevent and control infectious diseases at the local, state, national, and global levels [9].

The Centers for Disease Control and Prevention (CDC) took the Institute of Medicine report very seriously. Of the 15 recommendations in the report, we felt that over half were targeted primarily at CDC and most of those were directed at the National Center for Infectious Diseases. Therefore, we worked to develop a CDC plan, spurred on by a food-borne outbreak of *Escherichia coli* O157 in four western states identified in January 1993, a cryptosporidiosis water-borne outbreak in Milwaukee affecting over 400,000 people in April 1993, and the outbreak of Hantavirus Pulmonary Syndrome recognized in May 1993. The timing of the IOM report was uncanny since all three of these outbreaks occurred

within 8 months of its publication.

The experiences and lessons learned from these outbreaks helped shape the CDC Emerging Infections Plan, which was published in 1994 [4]. This plan contains four goals that focus on increasing surveillance and response capacity, addressing applied research priorities, strengthening prevention and control programs, and repairing the deterioration in the public health infrastructure locally, at the state level, nationally, and at the global level. The Plan, which has been partially implemented, has lost much of its specificity. An updated CDC Emerging Infections Plan will be published in the Fall of 1998.

An article in a national magazine prompted by the *E. coli* O157 outbreak early in 1993 asked a seemingly straight-forward question, "How safe is our food?". Unfortunately, given the inadequate state of food-borne disease surveillance in the United States, there has not been a clear answer to this question. Estimates have ranged from 6 million cases a year to 33 million cases to 81 million cases.

The National Food Safety Initiative was released in 1997. This strategy entitled, "Food Safety from Farm to Table" [8], indicates that the Clinton Administration is treating food safety in this country as a very high priority.

During the summer of 1997, the state public health laboratory in Colorado identified a cluster of 15 cases of *E. coli* O157:H7 infections, using molecular finger-printing techniques (pulse field gel electrophoresis), from widely scattered areas in the state [5]. A timely epidemiologic investigation implicated under-cooked ground beef from a single company. This observation led to a recall that expanded from 20,000 pounds of ground beef initially to 25 million pounds of ground beef. This outbreak illustrates the profound economic implications of emerging infectious disease outbreaks, and emphasizes the critical importance of public health laboratory capacity in outbreak detection and rapid public health action. Two years ago, it is doubtful that this outbreak would have even been detected. The National Molecular Subtyping Network [13] for food-borne disease surveillance (known as PulseNet), which is being developed and represents a model for disease surveillance in the future, played an important role in assessing the extent of this problem.

Drug resistance has received considerable attention nationally and globally and represents a serious public health threat. Strains of *Staphylococcus aureus* with diminished susceptibility to vancomycin were initially reported from Japan in the summer of 1997 [6]; within just a few weeks of that report, cases were recognized in the United States in Michigan and New Jersey [7]. Control of drug resistance is a major challenge requiring a multifaceted approach. However, John Burke summarized a critically important part of the problem, "Despite the multifactorial nature of antibiotic resistance, the central issue remains quite simple, the more you use it (the antimicrobial drug), the faster you lose it" [2]. Judicious antimicrobial use is an important component of the overall strategy to control this problem. We must do more than educate health care professionals about this need. We must educate the public as well regarding the need to conserve these valuable pharmaceutical resources by using them only as indicated. CDC, the American Society for Microbiology, and the American Academy of Pediatrics have jointly developed public educational materials in an effort to help address this need.

The recent H5N1 avian influenza outbreak in Hong Kong [14] required the assembly of a

multidisciplinary team involving extensive partnerships among organizations and agencies and was assembled to assess this urgent public health threat. The influenza strain, which had not previously been known to infect humans, apparently spread directly from chickens to people. Fortunately, this virus did not spread efficiently from person to person. This episode should serve as a wake-up call regarding the need for preparedness to confront the next influenza pandemic.

Clearly, the emerging infectious disease challenges of the future are going to require partnerships across disciplines; among agencies, academic institutions, organizations, societies, and foundations; and between the public and private sectors. It is critically important to have plans in place to confront these threats. The United States pandemic influenza response plan [11] that is nearing completion and the updated version of the CDC Emerging Infections Plan are two such examples.

What are some of the lessons we have learned during the past 5 years? Experience has reinforced the importance of surveillance, how critical it is to have the capacity to conduct a prompt epidemiologic investigation, how essential adequate diagnostic laboratory capacity is, how these outbreaks can disrupt travel and commerce, and the global implications that local problems can have. We have also learned that there is considerable media interest in these problems. The level of such interest, however, sometimes seems inversely proportional to the incidence of disease. The media interest is an asset in terms of providing the opportunity to communicate accurate information to policy makers and the public.

There is also a critical need to communicate new information on emerging infectious diseases to clinicians, microbiologists, biomedical researchers, and public health professionals. The CDC journal, *Emerging Infectious Diseases*, under the editorial leadership of Dr. Joseph McDade, is available in hardcopy or online through the CDC Web Site on the Internet (<http://www.cdc.gov>). The *Morbidity and Mortality Weekly Report*, and many other CDC publications relevant to emerging infections, are also available through the CDC Web Site.

In an effort to strengthen public health laboratory capacity, we have been working to re-establish a leadership role for CDC in training to provide persons with the skills needed to work effectively in state public health laboratories. We have established the CDC Emerging Infectious Diseases Laboratory Fellowship Program [1]. To date we have had 45 fellows participate in this program. An international track for this program will begin in 1998 in collaboration with the CDC Foundation and Eli Lilly and Company.

In 1995 the World Health Organization (WHO) created a new Division of Emerging and Other Communicable Diseases Surveillance and Control. WHO has also developed an emerging infections strategy which is being implemented under the leadership of Dr. David Heymann. WHO Regional Offices have also developed plans and are developing inventories of institutions in their regions with the capacity to address many of these issues.

What does the future hold? Although impossible to predict, we can be fairly certain we will have more problems with antimicrobial resistance; there will be another pandemic of influenza; and we are likely to continue to experience national and international food-borne disease outbreaks. We will also appreciate more and more the important role that microbes play in chronic diseases. The answer to the question, "Can we treat coronary artery

disease with antibiotics?”, might be yes [10]. Finally, we know we are going to have to continue to confront the unexpected. We could not have predicted the occurrence of AIDS nor do I think we could have predicted the occurrence of Hantavirus Pulmonary Syndrome. We must also be prepared to address the threat of bioterrorism.

Future strategies must avoid complacency. We must continue to develop and strengthen partnerships across disciplines and among organizations. We must strengthen research and training programs. Finally, we need to develop more effective educational programs targeted toward policy makers and the public.



# References

1. Anonymous. Emerging Infectious Diseases Fellowship Program. *Emerg Infect Dis* 1995;1:105.
2. Burke JP. How to maintain the miracle of antibiotics. *Lancet* 1995;345:977.
3. Burnet M, White DO. *Natural History of Infectious Disease*. London: Cambridge University Press; 1962.
4. Centers for Disease Control and Prevention. *Addressing Emerging Infectious Disease Threats: A Prevention Strategy for the United States*. Atlanta GA: U.S. Department of Health and Human Services, Public Health Service; 1994.
5. Centers for Disease Control and Prevention. *Escherichia coli* O157:H7 infections associated with eating a nationally distributed commercial brand of frozen ground beef patties and burgers—Colorado, 1997. *MMWR Morb Mortal Wkly Rep* 1997;46:777-78.
6. Centers for Disease Control and Prevention. Reduced susceptibility of *Staphylococcus aureus* to vancomycin—Japan, 1996. *MMWR Morb Mortal Wkly Rep* 1997;46:624-26.
7. Centers for Disease Control and Prevention. Update: *Staphylococcus aureus* with reduced susceptibility to vancomycin—United States, 1997. *MMWR Morb Mortal Wkly Rep* 1997;46:813-15.
8. Food Safety: From Farm to Table. A National Food-Safety Initiative. A Report to the President, May 1997. U.S. Department of Health and Human Services, U.S. Department of Agriculture, U.S. Environmental Protection Agency: Government Printing Office; 1997.
9. Lederberg J, Shope RE, Oaks SC Jr, editors. *Emerging Infections. Microbial Threats to Health in the United States*, Institute of Medicine. Washington, DC: National Academy Press; 1992.
10. Lip GYH, Beevers DG. Can we treat coronary artery disease with antibiotics? *Lancet* 1997;350:378-9.
11. Patriarca PA, Cox NJ. Influenza pandemic preparedness plan for the United States. *J Infect Dis* 1997;176(Suppl 1):S4-S7.
12. Pinner RW, Teutsch SM, Simonsen L, et al. Trends in infectious diseases mortality in the United States. *JAMA* 1996;275:189-93.
13. Stephenson J. New approaches for detecting and curtailing foodborne microbial infections. *JAMA* 1997;277:1337-40.
14. Subbarao K, Klimov A, Katz J, et al. Characterization of an avian influenza A (H5N1) virus isolated from a child with a fatal respiratory illness. *Science* 1998;279:393-6.
15. World Health Organization. *The World Health Report 1997: Conquering Suffering, Enriching Humanity*. Report of the Director-General. Geneva: World Health Organization; 1997.



# Emerging Infectious Diseases: An Overview

Maria Neira, M.D., M.P.H. and David L. Heymann, M.D.

*World Health Organization, Switzerland*

In the world today, the public health infrastructure for the prevention of infectious diseases has weakened, and natural and man-made phenomena such as population increase, overcrowding, and environmental changes are facilitating the emergence of previously unrecognized infectious diseases and the re-emergence of known diseases. The impact of these diseases is amplified by human travel and migration, and by the continuing evolution of antimicrobial resistance. The challenge in the 21st century will be to continue to provide resources to strengthen and ensure more cost-effective infectious disease control while also providing additional resources for other emerging public health problems such as those related to smoking and aging.

# A Twenty-Year Perspective

In the Democratic Republic of the Congo (DRC, ex-Zaire), the decrease in smallpox vaccination coverage, poverty, and civil unrest which caused humans to penetrate deep into the tropical rain forest in search of food, may have resulted in breeches in the species barrier between man and animals causing an extended and continuing outbreak of human monkeypox. During the 1970s and '80s when this zoonotic disease was the subject of extensive studies, it was shown that the monkeypox virus infected humans but that person-to-person transmission beyond three generations was rare [18]. The outbreak of human monkeypox in 1996-1997 is a clear example of the ability of infectious diseases to exploit weaknesses in our defenses against them.

Numerous infectious diseases have found weakened entry points into human populations and have emerged or re-emerged during the past 20 years. In the early to mid-1970s, for example, classic dengue fever began to reappear in Latin America after it had been almost eliminated as a result of mosquito control efforts in the 1950s and '60s [5]. Twenty years later, dengue has become hyper-epidemic in most of Latin America with over 500,000 cases reported in 1995-1996 of which over 13,000 in 25 countries were diagnosed with the hemorrhagic form [WHO, unpublished]. Cholera had not been reported in Latin America for over 100 years when it re-emerged in Peru in 1991 with over 320,000 cases and nearly 3,000 deaths. It spread rapidly throughout the continent and caused well over 1 million cases in a continuing and widespread epidemic [31].

The Ebola virus was identified for the first time in 1976, causing a disease which has come to symbolize emerging diseases and their potential impact on populations without previous immunological experience [9,10]. Ebola has caused at least four severe epidemics and numerous smaller outbreaks during the past 20 years since its identification in simultaneous outbreaks in Zaire and Sudan [2,7,8,26]. In 1976 at the time of the first Ebola outbreak in Zaire, HIV seroprevalence was already almost 1% in some rural parts of Zaire, shown retrospectively in blood which had been drawn from persons living in communities around the site of the 1976 outbreak [25]. HIV has since become a preoccupying public health problem worldwide.

# Misplaced Optimism

Within this same 20-year period, the eradication of smallpox was achieved [14]. This unparalleled public health accomplishment resulted in immeasurable savings in human suffering, death, and money, and stimulated other eradication initiatives. Transmission of poliomyelitis has been interrupted in the Americas with worldwide eradication expected during the coming decade [13]. During 1996, 2,090 cases of polio were reported to WHO, a decrease from 32,251 cases reported in 1988. Reported cases of dracunculiasis have decreased from over 900,000 in 1989 to less than 200,000 in 1996 with the majority of cases occurring in one endemic country [6]. Likewise, leprosy and Chagas disease continue their downward trends towards elimination [19,23].

The eradication of smallpox boosted an already growing optimism that infectious diseases were no longer a threat, at least to industrialized countries. This optimism had prevailed in many industrialized countries since the 1950s, a period which saw unprecedented development of new vaccines and antimicrobial agents and encouraged a transfer of resources and public health specialists away from infectious disease control. Optimism is now being replaced by an understanding that the infrastructure for infectious disease surveillance and control has suffered, and in some cases, become ineffective [11]. A combination of population shifts and movements, with changes in environment and human behavior, has created weaknesses in the defense systems against infectious diseases in both industrialized and developing countries.

# Weaknesses Facilitating Emergence and Re-emergence of Infectious Diseases

Weakening of the public health infrastructure for infectious disease control is evidenced by such failures as mosquito control in Latin America and Asia with the re-emergence of dengue now causing major epidemics [5]; failure of vaccination programs in eastern Europe contributing to the re-emergence of epidemic diphtheria and polio [12,28]; and neglect of yellow fever vaccination programs facilitating yellow fever outbreaks in Latin America and sub-Saharan Africa [29]. It is also clearly demonstrated by high levels of hepatitis B and nosocomial transmission of other pathogens such as HIV in the former USSR [27] and Romania [16], and nosocomial amplification of outbreaks of Ebola in Zaire where needles, syringes, and failed barrier nursing drove outbreaks into major epidemics [4].

Population increases and rapid urbanization during the past 20 years have resulted in a breakdown of sanitation and water systems in large coastal cities in Latin America, Asia, and Africa, thus promoting the transmission of cholera and shigellosis. In 1950, there were only two urban areas in the world with populations greater than 7 million, but by 1990 this number had risen to 23 with increasing populations in and around all major cities challenging the capacity of existing sanitary systems [1].

Man-made or natural effects on the environment also contribute to the emergence and re-emergence of infectious diseases. The effects range from global warming and consequent extension of vector-borne diseases, to ecological changes due to deforestation that increase contact between man and animals and also the possibility for microorganisms to breach the species barrier. These changes have occurred on almost every continent. They are exemplified by zoonotic diseases such as Lassa fever, first identified in West Africa in 1969 and now known to be transmitted to man from human food supplies contaminated with the urine of rats in search of food since their natural habitat could no longer support their needs [22]. The narrow band of desert in sub-Saharan Africa in which epidemic *Neisseria meningitidis* infections traditionally occur has enlarged as drought spreads south, so that countries such as Uganda and Tanzania now experience epidemic meningitis [21], while outbreaks of malaria and other vector-borne diseases have been linked to cutting of rainforests [34].

Finally, human behavior has played a role in the emergence and re-emergence of infectious diseases, best exemplified by the increase in gonorrhea and syphilis during the late 1970s [35], and the emergence and amplification of HIV worldwide [30], both of which are directly linked to unsafe sexual practices.

# Further Amplification

The emergence and re-emergence of infectious diseases are amplified by two major factors: the continuing and increasing evolution of antimicrobial resistance and dramatic increases in international travel. Antimicrobial agents are the basis for the management of important public health problems such as tuberculosis, malaria, sexually-transmitted diseases, and lower respiratory tract infections. Shortly after penicillin became widely available in 1942, Fleming sounded the first warning of the potential importance of resistance [20].

The mechanisms of resistance, a natural defense of microorganisms exposed to antimicrobials, include both spontaneous mutation and genetic transfer [20]. Selection and spread of resistant strains is facilitated by many factors including human behavior such as over-prescribing of antimicrobials, poor compliance, and unregulated sales by nonhealth care workers.

In addition to requiring increased treatment length with more expensive antimicrobial drugs or drug combinations, a doubling of mortality has been observed in some antimicrobial-resistant infections [17]. At the same time, fewer new antibiotics reach the market [3], possibly due, in part, to the risk of developing a new antimicrobial which may itself become ineffective before the investment is recovered. At present, there is no new class of broad-spectrum antibiotics on the horizon.

The role of travel in the spread of infectious diseases has been known for centuries. Today, when a traveler can be in a European or Latin American capital one day and in the center of Africa or Asia the next, humans, like mosquitoes, have become important vectors of disease. During 1995, over 500 million persons traveled by air [World Tourism Organization] contributing to the growing risk of exporting or importing infection or antimicrobial resistance. In 1988, a clone of multiresistant *Streptococcus pneumoniae* which was first isolated in Spain was later identified in Iceland [32]. Another clone of multiresistant *S. pneumoniae*, also first identified in Spain, was subsequently found in the United States, Mexico, Portugal, France, Croatia, Republic of Korea, and South Africa [24]. A study conducted by the Ministry of Health in Thailand of 411 exiting tourists showed that 11% had an acute infectious disease, mostly diarrhoeal in nature, but also respiratory infections, malaria, hepatitis, and gonorrhoea [B. Natth, personal communication]. Forced migration such as by refugees is also associated with the risk of re-emergence and spread of infectious diseases. As of January 1, 1996, there were over 26 million refugees in the world [UNHCR, 1996]. In a refugee population estimated to be between 500,000 and 800,000 in one African country in 1994, an estimated 60,000 developed cholera in the first month after the influx, and an estimated 33,000 died [15].

# Solutions

Eradication and regulation may contribute to the containment of infectious diseases, but they do not replace sound public health practices which prevent the weaknesses through which infectious diseases penetrate. Eradication was successful for smallpox and is advancing for poliomyelitis with viral transmission interrupted in the Americas. Eradication or elimination applies to very few infectious diseases, i.e., those which have no reservoir other than humans, trigger solid immunity after infection, and for which an affordable and effective intervention exists.

Attempts to regulate the spread of infectious diseases were first recorded in 1377 in a quarantine legislation designed to protect the city of Venice from plague-carrying rats on ships from foreign ports. Similar legislation in Europe, and later the Americas and other regions, led to the first international sanitary conference in 1851 which established a principle for protection against the international spread of infectious diseases: maximum protection with minimum restriction. Uniform quarantine measures were determined at that time, but a full century elapsed, with multiple regional and inter-regional initiatives, before the International Sanitary Rules were adopted in 1951. These were amended in 1969 to become the International Health Regulations (IHR) which are implemented by the World Health Organization (WHO).

The IHR provide a universal code of practice which ranges from strong national disease detection systems and measures of prevention and control including vaccination, to disinfection, disinsection, and de-ratting. The IHR currently require the reporting of three infectious diseases - cholera, plague, and yellow fever. When these diseases are reported, however, regulations are often misapplied resulting in disruption of international travel and trade, and huge economic losses. For example, when the present cholera pandemic reached Peru in 1991 it was immediately reported to WHO. In addition to its enormous public health impact, however, misapplication of the Regulations caused a severe loss in trade (due to concerns for food safety) and travel which has been estimated to be as high as 770 million US dollars.

A further problem with the IHR is that many infectious diseases, including those which are new or re-emerging, are not covered, despite their great potential for international spread. These range from relatively infrequent diseases such as viral hemorrhagic fevers to the more common threat of meningococcal meningitis.

Because of the problematic application and disease coverage of the IHR, WHO is currently revising and updating the IHR to make them more applicable to infection control in the 21st century. The revised Regulations will replace reporting of specific diseases, such as cholera, with reporting of disease syndromes such as epidemic diarrhoeal disease with high mortality. They will have a broader scope to include all infectious diseases of international importance, and will clearly indicate what measures are appropriate internationally, as well as those which are inappropriate. It is envisioned that the revised IHR will become a true global alert and response system to ensure maximum protection with minimum restriction.



the weakened public health infrastructure and strengthening of water and sanitary systems; minimizing the impact of natural and man-made changes to the environment; effectively communicating information about prevention of infectious diseases; and appropriately using antibiotics. The challenge in the 21st century will be to continue to provide resources to strengthen and ensure more cost-effective infectious disease control while also providing additional resources for other emerging public health problems such as those related to smoking and aging [33].

# References

1. An urbanizing world: Global report on human settlements, 1996. United Nations Centre for Human Settlements (HABITAT); 1996.
2. Baron RC, McCormick JB, Zubeir OA. Ebola virus disease in southern Sudan: hospital dissemination and intrafamilial spread. *Bull World Health Organ* 1983;61(6):997-1003.
3. Bax RP. Antibiotic resistance: A view from the pharmaceutical industry. *Clin Infect Dis* 1997;24(Suppl 1):S151-S153.
4. Breman JG et al. The epidemiology of Ebola haemorrhagic fever in Zaire, 1976. In: Pattyn SR, editor. *Ebola Haemorrhagic Fever*. Elsevier, North Holland Biomedical Press; 1978.
5. Dengue and dengue haemorrhagic fever in the Americas: Guidelines for Prevention and Control. Scientific Publication 548, PAHO, Washington D.C.; 1994.
6. Dracunculiasis. Global surveillance summary 1996. *Wkly Epidemiol Rec* 1997; 72(19):133-9.
7. Ebola haemorrhagic fever. *Wkly Epidemiol Rec* 1995;70(34):241-2.
8. Ebola haemorrhagic fever. A summary of the outbreak in Gabon. *Wkly Epidemiol Rec* 1997;72(1/2):7-8.
9. Ebola haemorrhagic fever in Sudan, 1976. Report of a WHO/International Study Team. *Bull World Health Organ* 1978;56(2):247-70.
10. Ebola haemorrhagic fever in Zaire, 1976. Report of an International Commission. *Bull World Health Organ* 1978;56(2):270-93.
11. Lederberg J, Shope RE, Oaks SC Jr, editors. *Emerging Infections. Microbial Threats to Health in the United States*, Institute of Medicine. Washington, DC: National Academy Press; 1992.
12. Expanded Programme on Immunization (EPI). Update: Diphtheria epidemic in the Newly Independent States of the former USSR, January 1995-March 1996. *Wkly Epidemiol Rec* 1996;71(33):245-50.
13. Expanded Programme on Immunization (EPI). Progress towards the global eradication of poliomyelitis, 1996. *Wkly Epidemiol Rec* 1997;72(26):189-94.
14. Fenner F, Henderson DA, Arita I, et al. *Smallpox and its eradication*. WHO, Geneva; 1988.
15. Goma Epidemiology Group. Public Health impact of Rwandan refugee crisis: what happened in Goma, Zaire, in July, 1994? *Lancet* 1995;345:339-44.
16. Hersh BS, Popovici F, Jezek Z, et al. Risk factors for HIV infection among abandoned Romanian children. *AIDS* 1993;7(12):1617-24.
17. Holmberg SD, et al. Health and economic impact of antimicrobial resistance. *Rev Infect Dis* 1987;9:1065-78.
18. Jezek Z, Fenner F. Human monkeypox. *Monographs in Virology*, Vol. 17; 1988.
19. Leprosy situation in the world 1997. *Wkly Epidemiol Rec* 1979;72(39):294-5.
20. Levy SB, editor. *The Antibiotic Paradox. How Miracle Drugs are Destroying the Miracle*. New York: Plenum Trade; 1992.
21. Meningococcal meningitis. *Wkly Epidemiol Rec* 1995;70(15):105-7.

22. Monath TP. Lassa fever: review of epidemiology and epizootiology. *Bull World Health Organ* 1975;52:577-92.
23. Moncayo A. Progress towards the elimination of transmission of Chagas disease in Latin America. *World Health Stat Q.* 1997;50(3-4):195-8.
24. Munoz R, Coffey TJ, Daniels M, et al. Intercontinental spread of a multiresistant clone of serotype 23F *Streptococcus pneumoniae*. *J Infect Dis* 1991;164:302-6.
25. Nzilambi N, DeCock KM, Forthal DN, et al. The prevalence of infection with human immunodeficiency virus over a 10-year period in rural Zaire. *New Engl J Med* 1988;318(5):276-9.
26. Outbreak of Ebola haemorrhagic fever in Gabon officially declared over. *Wkly Epidemiol Rec* 1996;71(17):125-6.
27. Pokrovskii VV, et al. Transmission of HIV-1 from infant to mother during breastfeeding (in Russian). *Zurnal mikrobiologii, epidemiologii i immunobiologii* 1990;3:23-6.
28. Poliomyelitis outbreak. *Wkly Epidemiol Rec* 1996;71(39):293-5.
29. Robertson SE, Hull BP, Tomori O, Bele O, LeDuc JW, Esteves K. Yellow fever. A decade of reemergence. *JAMA* 1996;276(14):1157-62.
30. Sato PA, Chin J, Mann M. Review of AIDS and HIV infection: Global epidemiology and statistics. *AIDS* 1989;3(Suppl 1):S301.
31. Siméant S. Choléra, 1991 - viel ennemi, nouveau visage. *World Health Stat Q* 1992;45(2/3):208-19.
32. Soares S, Kristinsson KG, Musser JM, Tomasz A. Evidence for the introduction of a multiresistant clone of 6B *Streptococcus pneumoniae* from Spain to Iceland in the late 1980s. *J Infect Dis* 1993;168:158-63.
33. The Global Burden of Disease. A Comprehensive Assessment of Mortality and Disability from Diseases, Injuries, and Risk Factors in 1990 and Projected to 2020. Murray CJL, Lopez AD, editors. Harvard School of Public Health, World Health Organization, World Bank; 1996.
34. Walsh JF, Molyneux DH, Birley NH. Deforestation: effects on vector-borne diseases. *Parasitology* 1993;106(Suppl):S55-S75.
35. Wasserheit JN. Effect of changes in human ecology and behavior on patterns of sexually transmitted diseases, including human immunodeficiency virus infection. *Proc Nat Acad Sci USA* 1994;91:2430-35.



# Controlling Antimicrobial Resistance in Health Care Systems — A Multifaceted Problem

John E. McGowan, Jr., M.D.

*Emory University, U.S.A.*

New resistance patterns continue to develop in the microorganisms that cause infection, not only in acute care hospitals, but also among the other key settings of managed health care systems. Appropriate control measures for such resistant organisms depend in part on the pathways by which resistance has arisen. Unfortunately, these pathways differ greatly from organism to organism and setting to setting. Effective measures are needed to decide how to use limited health care system resources to achieve the greatest control of resistant strains. Among the most important measures is improving the use of antimicrobial agents. Dealing with the use of antibiotics in the hospital is difficult, but recent studies are now identifying effective approaches. There is a great need for new methods to control the clonal spread of organisms within health care systems. Likewise, lacking are procedures to decontaminate or disinfect environmental sites and objects that can serve as a reservoir or source for the spread of organisms that cause nosocomial infections. Solutions to these problems are critical to the success of health care systems.

# Introduction

Antimicrobial-resistant microorganisms have become increasingly frequent in the health care setting [35]. In part, this is because of the presence of more patients with impaired host defenses, use of new instrumentation and procedures, decreasing resources for infection control, and the inability of some laboratory methods to detect novel resistance mechanisms [49]. Most bacterial strains that are frequent sources of nosocomial infections have been consistently susceptible to all antimicrobial agents for decades [47]. Some have now developed resistance, not only to those classic therapies, but to newer agents as well [39]. Other organisms have developed resistance to new antimicrobials almost as soon as these agents have been marketed [8].

An increase in organisms that are resistant to several different groups of antimicrobials has been noted recently [48]. These multi-drug resistant (MDR) microbes now cause an increasing number of infections each year. Such infections were previously seen primarily in the intensive care units (ICU) of hospitals, but now occur in other inpatient wards and even in ambulatory care settings [2]. In some cases, MDR strains have become so prominent that keeping patients with serious infections alive has become a difficult task, similar to that seen in the preantibiotic era [19].

As the magnitude of this problem continues to broaden, it is imperative that health care professionals become familiar with the causes of antibiotic resistance and the ways in which the emergence of resistance in bacteria can be prevented or minimized [48]. Moreover, managed health care systems are becoming a prominent feature of medical practice in the United States today [25,38]. It is no longer sufficient, therefore, to consider cross-infection solely in the context of the acute care hospital. Rather, the impact on acute care, extended care, and ambulatory components of the integrated delivery organization must be assessed [43]. The definition of the term 'nosocomial', therefore must be expanded. For many years this term referred to events in the acute care hospital. The definition must now be broadened to encompass infections occurring in all care settings used by a health care system, whether inpatient or ambulatory.

The conditions that favor the development and spread of resistant organisms are abundant in all sites of a typical health care system: acute hospital, extended care facility, and ambulatory clinic. Thus, we can expect resistant organisms to continue as a serious impediment to the development, operation, and profitability of managed care systems. This article will highlight some of the factors leading to the development of resistance in organisms found in various parts of the health care system and the problems of control and prevention of spread of these resistant bacteria in health care settings.

# Pathways by Which Resistance Appears

Six pathways have been described for the appearance or spread of bacterial resistance [35]. As seen in Table 1, each of these pathways may conceivably have a role in the appearance or increase of resistant organisms in several different settings of the health care system. Risk determinants that facilitate the operation of each of these pathways are also listed in Table 1.

New resistant bacterial strains may be introduced into the hospital setting via a patient from the outside, a health care worker from the outside or from another institution, or a contaminated commercial product. Introduction of resistant strains into hospitals from nursing homes and extended care facilities, as well as transfer in the opposite direction from hospitals to nursing homes, has become common for certain pathogens [37]. Resistant organisms may be more difficult to eradicate in certain parts of the health care system than in others. For example, extensive resources have been needed to eradicate methicillin-resistant strains of *Staphylococcus aureus* (MRSA) once they have been introduced [24].

**Table 1. Pathways by Which Resistance Appears or is Spread and Risk Determinants for Operation of Each Pathway**

Pathway	Risk Determinants
1. Introduction	Entry of Patient with Resistant Organism by: Transfer from other institutions in the health care system (acute care, extended care, etc.) Transfer from outside system Entry from community
2. Mutation, Genetic Transfer	Reservoirs with High Organism Concentration (increased chance for random mutation or transfer — lung abscess, abdominal abscess, etc.)
3. Emergence, Selection	Selective Pressures from Antimicrobial Use (whether or not prescribed appropriately) Improper or Insufficient Barrier Isolation Precautions
4. Dissemination Within the Institution	Lack of Attention to Major Vectors of Transmission (intravenous catheters, transducers, respiratory therapy equipment, etc.)

Adapted with permission from reference 35.

Resistance can be acquired by a previously susceptible strain from another species or genus [49]. Both genetic mutation or transfer of genetic material can produce this. Changes in only a few base pairs, causing substitution of one or a few amino acids in a crucial target (enzyme, cell structure, or cell wall) can affect chromosomal structure or control genes leading to new resistant strains. The changed defense is often able to inactivate whole groups of antimicrobials. Many of the antibacterial resistance genes are on plasmids that

can, and do, transfer themselves to another genus or species of bacteria. Genetic mutations may lead to resistance without altering the pathogenicity or viability of a bacterial strain [17]. This pathway is presumed to be the means by which enterococci exchange genes with other gram-positive organisms. This exchange has not occurred in the past because these organisms seldom encounter each other in nature [41]. Both organisms are an important part of the ecosystem of the acute care hospital, however, and this is where glycopeptide-resistant, as well as beta-lactamase-producing enterococci, were first observed [36]. Other bacterial resistance emerging by mutation or transfer has first been detected in the ambulatory care setting. For example, resistance to penicillin in isolates of *Streptococcus pneumoniae* appears at least as frequently in ambulatory care clinic patients as in those who are hospitalized [22].

Chromosomal determinants for resistance to a given drug may not be expressed until the organism comes in contact with it or similar compounds. When permissive conditions appear (e.g., new antibiotics in use, introduction of new conjugative plasmids), the resistance can be manifested rapidly [7]. The trigger for emergence may be the antimicrobial agent to which resistance is directed. In some cases, exposure to another antimicrobial results in induction or de-repression of a determinant (enzyme, etc.) that stimulates resistance as well to the studied drug [43]. Likewise, exposure to a stimulus that inhibits or kills the susceptible majority of a population allows a resistant subset of strains to grow at the expense of susceptible organisms. The selection factor is usually the antibiotic to which the subpopulation is resistant, but on occasion a related agent can have a great impact as well; non-drug factors such as those stimulating activity of reactions like acetylation or glucuronylation can also provide a selective advantage to organisms [32]. This explains why health care systems must examine the use of all antimicrobial agents in all settings that are part of the system, rather than only examining the use of the drug to which resistance has occurred or is feared. For certain organism-drug combinations, use of the drug itself seems closely linked to resistance [31].

Organisms can be spread from patient to patient, from one patient to another via a health care worker (e.g., on the hands of ward personnel), in contaminated commercial products (e.g., antiseptics), on other inanimate objects, or by widespread transfer of genetic material from the initial organism to others. The importance of cross-transmission varies from one health care system to another. For example, a study from France found “a ubiquitous and prevalent clone” to be responsible for more than half of the clinical isolates of *Enterobacter aerogenes* in two intensive care units [10], thus suggesting a major role for cross-infection.

Bacteria and other nosocomial pathogens can resist antimicrobials in several ways [17]. Most current outbreaks of resistance in hospital or community settings, and virtually all endemic occurrences of resistance, involve a number of these pathways, each to a greater or lesser degree [50]. Risk determinants associated with each have been defined (Table 2). Organizing the multiple and concurrent elements that lead to the appearance and spread of resistance is an important but difficult problem [35].



## Pathway<sup>1</sup> by Which Resistance Appears or Is Spread

---

### 1. **Pathway: Introduction of Organism from External Source**

Surveillance and Empiric Isolation

Survey for Resistance in Patients Coming from Known Reservoirs of Resistant Organisms (chart flagged, etc.)

Implement Barrier Isolation Precautions for Patients from Known Sites Within or Outside the Health Care System (discontinue precautions only after cultures negative)

### 2. **Pathway: Mutation, Genetic Transfer**

Decrease Reservoirs of Organisms with Potential for Mutation (proper care of instruments, fluids, selective decontamination, etc.)

### 3. **Pathway: Emergence, Selection**

Decrease Antibiotic Selective Pressures

### 4. **Pathway: Dissemination Within the Institution**

Institute Barrier Isolation Precautions to Contain Resistant Organisms (by attention to reservoirs and pathways of spread)

Maintain Proper Use of Equipment and Procedures (major risk determinants for spread)

---

<sup>1</sup> Pathways are those described in Table 1.

Adapted with permission from reference 35.

# Prevention and Control of Resistance

Several approaches are possible to minimize the threat of newly-resistant organisms [35]. For many decades, the first line of defense has been the development of new antimicrobials. New agents that can contain today's resistant organisms, however, are not likely to be available for several years [6]. Even when available, newer agents are almost always more costly, and often more toxic than the current agents that organisms have learned to resist [16]. Other strategies are therefore needed. Four strategies are discussed in detail below because they have a close connection with the resistance pathways described above (Table 2).

## *Dealing With the Introduction of New Organisms – Targeted Surveillance and Isolation*

As resistant organisms such as MRSA spread into the community, a higher proportion of patients are found to be colonized on admission or upon transfer to acute care hospitals from other facilities [5]. Control measures for this setting increasingly rely on identifying carriers of the organism at the time of admission to acute care hospitals. When these patients are promptly recognized, they are then placed in isolation until studies determine whether or not they are colonized with resistant organisms. Procedures for evaluating the efficiency of this process have been devised [4]. At the University of Virginia Hospital, the performance of this type of control for MRSA was felt effective, and a cost-benefit analysis supported the value of these activities [24]. How well this system will work for other resistant organisms is unclear and must be further examined.

## *Dealing With Mutation and Genetic Transfer – Decreasing Concentrations of Organisms*

The larger the concentration of organisms at a given site, the greater the potential that one or more isolates will develop resistance by mutation or genetic transfer. Thus, resistance can be minimized by eradicating reservoirs of organisms that have a high likelihood of developing resistance as well as small foci of organisms already resistant [51]. Such measures decrease the population in which further resistance can potentially arise. For example, MRSA colonization may be reduced by use of intranasal topical antibiotic ointment [12]. This approach may be particularly applicable to long-term care facilities, where colonization of the anterior nares by MRSA seems to precede most infections. High-level resistance to mupirocin is carried on plasmids, however, and can lead to situations where this agent cannot be employed [3].

Selective decontamination of gastrointestinal flora or endogenous organisms at other sites has been suggested as a means to reduce organism concentration and thus, control resistance [13]. A recent trial of selective decontamination of gut flora conducted in a medical-surgical intensive care unit produced little impact on resistance [50].

Some microorganisms have attributes that permit survival in or around instruments and catheters; these characteristics may be entirely independent of the organism's susceptibility to antimicrobials. The result of interaction with these materials is that organism concentration can reach appreciable levels in and around the medical instrument. Thus,

instruments can serve as the vehicles for mutation or transfer. This emphasizes the important role of proper design and use of instruments and catheters as a measure for controlling resistance.

### *Dealing With Emergence and Selection – Improving Use of Antimicrobial Agents*

Selective pressure refers to the environmental conditions that allow organisms with novel mutations or newly acquired characteristics to survive and proliferate [48]. Antimicrobial resistance is spawned, in large measure, by the selective pressures of antibiotic use [13,20]. There is some evidence to suggest an association between antimicrobial use in hospitals and antimicrobial resistance, an association that is likely causal. The causal relationship is not absolutely clear due to the lack of uniformity of definitions of resistance, variations in susceptibility test methods, potential study selection biases, and failure to control for confounding variables, especially infection control measures in the hospital or extended care setting [33]. The association of intense antibiotic use with specific drug resistance in a given hospital has been demonstrated repeatedly [47] which has led authors to suggest that “amplification of resistance by antibiotic use is a major, perhaps *the* major factor” [16]. In particular, overuse and misuse of newer, broad-spectrum antimicrobials have accelerated the problem [27].

Since antimicrobial use is a major risk factor for resistance, improving antimicrobial use must be a cornerstone when dealing with multiresistant organisms. Yet, as Greenwood notes, “these life-saving drugs have been used with unrestrained enthusiasm far surpassing the needs of the management and control of infection.” [20]. In addition, antimicrobial control by itself will seldom be sufficient to deal with all resistance problems. For example, the reduction in the use of an antibiotic in the hospital must occur before the resistant strains become entrenched and survive for reasons unrelated to selective antimicrobial pressure [47]. Furthermore, modeling of the relationship between use and resistance by the methods of population genetics suggests that without complete termination of use of an antimicrobial, the rates at which resistance declines will not be great [29].

The specific methods that best achieve antimicrobial control are also not clear. While many methods and programs have been described, controlled data on the effectiveness of these interventions in modifying antibiotic prescribing or other relevant behavior are limited. Careful, controlled evaluations are still needed to determine the outcome of each type of intervention. Two major approaches that have been attempted are educational efforts and programs to control or restrict antibiotic use.

Historically, improving antibiotic use through education of prescribers has been a goal of many programs and is an important goal of quality assurance programs [27]. To date, however, few educational programs have been reported that exert an effective influence on antibiotic prescribing [34]. Moreover, when educational programs are de-emphasized because of cost or loss of enthusiasm, antibiotic use has been found to return to a less than desirable level of quality [11]. Guidelines and treatment algorithms are currently being produced by several professional societies and governmental agencies [21]. To date, however, the overall impact of these has been small. The addition of peer review and

quality management approaches to the implementation of guidelines has also not led to uniform success [26].

When educational efforts fail to produce results, more restrictive measures have been employed. Interest in such control programs has recently increased, especially for acute care hospitals. Calls for monitoring prescribing practices have been issued as the appreciation of the importance of antibiotic use as a prelude to new resistance patterns increases [23,36]. Quality-improvement strategies for improving antimicrobial use advocate 'administrative' as well as 'educational' means [18]. It must be remembered, however, that there are also potential disadvantages of intensive control programs [34].

The basic elements of a good resistance prevention program include an active system of surveillance for resistance, an active and effective infection control program to minimize secondary spread of resistance, and an effective program of antimicrobial use stewardship [34]. The latter element, sometimes referred to as 'antibiotic control,' involves not only the limitation of use of inappropriate agents, but also the proper use, dosing, and duration of antimicrobials to achieve optimal efficacy in treating and preventing infections. It does not necessarily entail removal of specific drugs from the list of available agents, or restriction of specific drugs to certain groups of specialists.

### *Dealing With Dissemination Within the Institution – Barrier Isolation Precautions and Proper Use of Instruments and Procedures*

Measures for the containment of infection ('barrier isolation precautions') have been postulated to have a major impact on keeping nosocomial pathogens, including resistant ones, in check [45]. If these isolation procedures actually reduce the prevalence of resistance, implementation efforts are worthwhile, because infection with resistant organisms has severe economic consequences [52].

The relative importance of barrier techniques as control measures varies from site to site, depending upon which resistant organisms are most prominent at a given institution. For example, measures recommended for control of enterococcal isolates resistant to high levels of gentamicin include not only changes in antibiotic use (care in prescribing of aminoglycoside and cephalosporins) but also strict attention to handwashing and other infection control measures [40]. In general, barrier isolation precautions have been successful in reducing spread where hospitalized patients have acquired the resistant organism from an exogenous source. By contrast, when the organisms are endogenous to the patient, barrier infection control procedures have been less successful in containing the problem. For example, few of the *Enterobacter* infections associated with a cardiac surgery intensive care unit were amenable to control by isolation precautions, as the patients' infections arose from endogenous strains rather than from exogenously acquired isolates [14].

For most of the resistance pathways listed in Table 1, classic measures to contain the spread of resistant organisms are of little help. Resistance that arises by spontaneous mutation, plasmid transfer, emergence of latent resistance, or selection of resistant subpopulations is likely to occur and persist, at least in focal fashion, regardless of the

quality of isolation precautions. For these situations, the primary role of classic isolation precautions (universal precautions, body substance isolation, etc.) is to prevent dissemination of the resistant organisms. In addition, isolation measures are usually impractical in the community. Thus, these measures are practical and cost-effective in some, but not all, sites of the health care system.

# Guidelines for Control Must be Individualized

Outbreaks of infection due to resistant organisms require a combination of measures to insure control. These measures, however, will have to be individualized to specific organism-antimicrobial pairs, specific health care institutions, and specific systems for health delivery.

The reservoir and mode of spread for important resistant organisms varies dramatically. For some, like MRSA, the reservoir is now in some communities as well as in health care facilities [28]. For others, such as ESBL-containing Gram-negative bacilli, acute care hospitals, and in particular, intensive care units, are the main target [9]. Likewise, the mode of MRSA spread seems closely linked to person-to-person spread, while Gram-negative nonfermenting bacillary infections appear to be spread through liquids and respiratory therapy devices. Thus, one set of national guidelines for dealing with resistant organisms is unlikely to suffice for resistance in different organisms.

In a similar fashion, the health care setting in which resistant organisms are being encountered plays a strong role in the design of control measures. For example, plans for resistance control in long-term care facilities must be customized to the patients and types of care given in these facilities, where “strategies used in hospitals often are inapplicable” [37,45]. Likewise, guidelines for dealing with the home care setting will have to be adjusted in a similar fashion from setting to setting [30].

Finally, the approach to dealing with resistance is likely to vary not only from organism to organism but also from institution to institution, and health care system to health care system. A pilot program which is part of a cooperative effort by the Rollins School of Public Health of Emory University and the Hospital Infections Program of the CDC illustrates this point. Dubbed Project ICARE (Intensive **C**are **A**ntimicrobial **R**esistance **E**pidemiology), the study involved eight hospitals participating in the NNIS system that reported additional information on antimicrobial resistance and antimicrobial use [2]. Study of the data on MRSA showed that antimicrobial use and resistance were closely linked in some, but not all, of the hospitals. At one site, problems with infection control leading to cross-infection appeared to be a major cause of resistance, while at another site hospital levels of resistant organisms seemed to be due to a high prevalence of resistant isolates in the community. Thus, in deciding how to approach antimicrobial resistance, national or regional guidelines for resistance prevention will have to be modified by local or regional health care systems to account for local patterns, problems, and resources. These entities will need to consider their own policies, resources, and patient populations in interpreting national guidelines.

# Antimicrobial Resistance Must be a Concern for All

Several steps are needed to deal with these new resistant organisms. Among the most important measures in solving the problem of resistant organisms is by improving the use of antimicrobial agents. The prudent use of all antimicrobial agents is critical to maintaining their effectiveness. The problem of antimicrobial resistance will not likely be solved, however, until the entire health care delivery system becomes involved in the campaign [16,44]. For health care systems, this means system-wide evaluations of the magnitude of the problem in the different units and assessment of the resources available in each [43]. System-wide studies of this type are currently being conducted for infection control practices [15]. They must be added for resistance as well.

# References

1. Acar J. Broad- and narrow-spectrum antibiotics: an unhelpful categorization. *Clin Microbiol Infection* 1997;3:395-6.
2. Archibald L, Phillips L, Monnet D, McGowan JE Jr, Tenover F, Gaynes R. Antimicrobial resistance in isolates from inpatients and outpatients in the United States: increasing importance of the intensive care unit. *Clin Infect Dis* 1997;24:211-5.
3. Boyce JM. Preventing staphylococcal infections by eradicating nasal carriage of *Staphylococcus aureus*: proceeding with caution. *Infect Control Hosp Epidemiol* 1996;17:775-9.
4. Boyce JM, Vallande N, Hughes N, Chenevert C. Compliance with hospital policies for readmission of patients with methicillin-resistant *Staphylococcus aureus* (MRSA) (abstract S57). *Infect Control Hosp Epidemiol* 1996;17(5 Pt 2):P36.
5. Burt J-A, Garcia M, Jolley B-A, et al. The epidemiology and control of methicillin-resistant *Staphylococcus aureus* (MRSA) over 15 years at a large tertiary care Canadian hospital (abstract 76). *Infect Control Hosp Epidemiol* 1996;17(5 Pt 2):P28.
6. Chopra I, Hodgson J, Metcalf B, Poste G. New approaches to the control of infections caused by antibiotic-resistant bacteria. An industry perspective. *JAMA* 1996;275:401-3.
7. Chow JW, Fine MJ, Shlaes DM, et al. *Enterobacter* bacteremia: clinical features and emergence of antibiotic resistance during therapy. *Ann Intern Med* 1991;115:585-90.
8. Coronado VG, Edwards JR, Culver DH, Gaynes RP, National Nosocomial Infections Surveillance System. Ciprofloxacin resistance among nosocomial *Pseudomonas aeruginosa* and *Staphylococcus aureus* in the United States. *Infect Control Hosp Epidemiol* 1995;16:71-8.
9. Coudron PE, Moland ES, Sanders CC. Occurrence and detection of extended-spectrum b-lactamases in members of the family *Enterobacteriaceae* at a Veterans Medical Center: seek and you may find. *J Clin Microbiol* 1997;35:2593-7.
10. Davin-Regli A, Monnet D, Saux P, et al. Molecular epidemiology of *Enterobacter aerogenes* acquisition: one-year prospective study in two intensive care units. *J Clin Microbiol* 1996;34:1474-80.
11. Dunagan WC, Medoff G. Formulary control of antimicrobial usage. What price for freedom? *Diagn Microbiol Infect Dis* 1993;16:265-74.
12. Eltringham I. Mupirocin resistance and methicillin-resistant *Staphylococcus aureus* (MRSA). *J Hosp Infect* 1997;35:1-8.
13. Flaherty JP, Weinstein RA. Nosocomial infection caused by antibiotic-resistant organisms in the intensive-care unit. *Infect Control Hosp Epidemiol* 1996;17:236-48.
14. Flynn D, Weinstein RA, Kabins SA. Infections with gram-negative bacilli in a cardiac surgery intensive care unit: the relative role of enterobacter. *J Hosp Infect* 1988;11(Suppl A):367-73.
15. Fraser VJ, L'Ecuyer PB, Woeltje KF, Seiler S, Simmons BP. Evaluation of infection control practices in a multi-hospital system (abstract 54). *Infect Control Hosp Epidemiol* 1996; 17(5 Pt 2):P24.
16. Gaynes R. Antibiotic resistance in ICUs: a multifaceted problem requiring a



- multifaceted solution. *Infect Control Hosp Epidemiol* 1995;16:328-30.
17. Gold HS, Moellering RC, Jr. Antimicrobial-drug resistance. *N Engl J Med* 1996;335:1445-53.
  18. Goldmann DA, Weinstein RA, Wenzel RP, et al. Strategies to prevent and control the emergence and spread of antimicrobial-resistant microorganisms in hospitals - a challenge to hospital leadership. *JAMA* 1996;275:234-40.
  19. Greenwood D. Preserving the miracle of antibiotics. *Lancet* 1995;345:1371.
  20. Greenwood D. Tarnished gold: sixty years of antimicrobial drug use and misuse. *J Med Microbiol* 1996;43:395-6.
  21. Gross PA, Barrett TL, Dellinger EP, et al. Purpose of quality standards for infectious diseases. *Clin Infect Dis* 1994;18:421.
  22. Hoffmann J, Cetron MS, Farley MM, et al. The prevalence of drug-resistant *Streptococcus pneumoniae* in Atlanta. *N Engl J Med* 1995;333:481-6.
  23. Hospital Infection Control Practices Advisory Committee (HICPAC). Recommendations for preventing the spread of vancomycin resistance. *Infect Control Hosp Epidemiol* 1995;16:105-13.
  24. Jernigan JA, Clemence MA, Stott GA, Titus MG, et al. Control of methicillin-resistant *Staphylococcus aureus* at a university hospital: one decade later. *Infect Control Hosp Epidemiol* 1995;16:686-96.
  25. Kassirer JP. The new health care game. *N Engl J Med* 1996;335:433.
  26. Kritchevsky SB, Simmons BP. Toward better antibiotic use in hospitals. *Infect Control Hosp Epidemiol* 1994;15:688-90.
  27. Kunin CM. Resistance to antimicrobial drugs - a worldwide calamity. *Ann Intern Med* 1993;118:557-61.
  28. Layton MC, Hierholzer WJ Jr, Patterson JE. The evolving epidemiology of methicillin-resistant *Staphylococcus aureus* at a university hospital. *Infect Control Hosp Epidemiol* 1995;18:12-17.
  29. Levin BR, Lipsitch M, Perrot V, et al. The population genetics of antibiotic resistance. *Clin Infect Dis* 1997;24 Suppl 1:S9-S16.
  30. Lorenzen AN, Itkin DJ. Surveillance of infection in home care. *Am J Infect Control* 1992;20:326-9.
  31. Lubber AD, Jacobs RA, Jordan M, Guglielmo BJ. Relative importance of oral versus intravenous vancomycin exposure in the development of vancomycin-resistant enterococci. *J Infect Dis* 1996;173:1292-3.
  32. McGowan JE Jr. Antimicrobial resistance in hospital organisms and its relation to antibiotic use. *Rev Infect Dis* 1983;5:1033-48.
  33. McGowan JE Jr. Do intensive hospital antibiotic control programs prevent the spread of antibiotic resistance? *Infect Control Hosp Epidemiol* 1994;15:478-83.
  34. McGowan JE Jr, Gerding DN. Does antibiotic restriction prevent resistance? *New Horizons*. In press 1996.
  35. McGowan JE Jr, Tenover FC. Control of antimicrobial resistance in the health care system. *Infect Dis Clin N Amer* 1997;11:297-311.
  36. Murray BE. Can antibiotic resistance be controlled? *N Engl J Med* 1994;330:1229-30.

37. Nicolle LE, Bentley D, Garibaldi R, Neuhaus E, Smith P, SHEA Long-Term-Care Committee. SHEA position paper: antimicrobial use in long-term-care facilities. *Infect Control Hosp Epidemiol* 1996;17:119-28.
38. Nolan TW. Understanding medical systems. *Ann Intern Med* 1998;128:293-8.
39. Palzkill T.  $\beta$ -lactamases are changing their activity spectrum. *ASM News* 1998;64:90-5.
40. Patterson JE, Sanchez RO, Hernandez J, Grota P, Rose KA. Special organism isolation: attempting to bridge the gap. *Infect Control Hosp Epidemiol* 1994;15:335-8.
41. Rowe PM. Preparing for battle against vancomycin resistance. *Lancet* 1996;347:252.
42. Sanders CC, Wiedemann B. Conference summary. *Rev Infect Dis* 1988;10:679-80.
43. Shlaes DM, Gerding DN, John JF Jr, et al. Society for Healthcare Epidemiology of America and Infectious Diseases Society of America Joint Committee on the Prevention of Antimicrobial Resistance: Guidelines for the prevention of antimicrobial resistance in hospitals. *Clin Infect Dis* 1997;25(3):584-99.
44. Schwartz B, Bell DM, Hughes JM. Preventing the emergence of antimicrobial resistance. A call for action by clinicians, public health officials, and patients. *JAMA* 1997;278: 944-5.
45. Skolnick A. New insights into how bacteria develop antibiotic resistance. *JAMA* 1991;265:14-16.
46. Strasbaugh LJ, Crossley KB, Nurse BA, Thrupp LD, SHEA Long-Term-Care Committee. SHEA position paper: Antimicrobial resistance in long-term-care facilities. *Infect Control Hosp Epidemiol* 1996;17:129-40.
47. Swartz MN. Use of antimicrobial agents and drug resistance. 1997;337:491-2.
48. Tenover FC, Hughes JM. The challenges of emerging infectious diseases. Development and spread of multiple-resistant bacterial pathogens. *JAMA* 1996;275:300-4.
49. Tenover FC, McGowan JE Jr. Reasons for the emergence of antibiotic resistance. *Am J Med Sci* 1996;311:9-16.
50. Weiner J, Itokazu G, Nathan C, Kabins SA, Weinstein RA. A randomized, double-blind placebo-controlled trial of selective decontamination in a medical-surgical intensive care unit. *Clin Infect Dis* 1995;20:861-7.
51. Weinstein RA, Kabins SA. Strategies for prevention and control of multiple-drug resistant nosocomial infections. *Am J Med* 1991;70:449-54.
52. Wong AHM, Nicolle LE, Roberts DE. Outcomes of nosocomial pneumonia with resistant organisms in intensive care patients [abstract S3]. *Infect Control Hosp Epidemiol* 1996;17(5 Pt 2):P30.



# Experimental Inoculation of Plants and Animals with Ebola Virus<sup>1</sup>

Robert Swanepoel<sup>1</sup>, Patricia A. Leman<sup>1</sup>, Felicity J. Burt<sup>1</sup>,  
Nicholas A. Zachariades<sup>1</sup>, Lawrence E.O. Braack<sup>2</sup>, Thomas G.  
Ksiazek<sup>3</sup>, Pierre E. Rollin<sup>3</sup>, Sherif R. Zaki<sup>3</sup>, and Clarence J.  
Peters<sup>3</sup>

<sup>1</sup>*National Institute for Virology, South Africa;*

<sup>2</sup>*National Parks Board, South Africa;*

<sup>3</sup>*Centers for Disease Control and Prevention, U.S.A.*

As an adjunct to field studies aimed at seeking the natural hosts of filoviruses, it was decided to determine whether a range of candidate species could support the replication of Ebola virus. Thirty-three varieties of 24 species of plants and 19 species of vertebrates and invertebrates were experimentally inoculated with Ebola Zaire virus. Fruit and insectivorous bats supported replication and circulation of high titers of virus without necessarily suffering ill effects, with deaths occurring only in individuals which had not adapted to the diet fed in the laboratory. Other species of animals and plants proved to be refractory to infection.

The taxonomy of the *Filoviridae* is in a state of flux; the family includes viruses currently designated Marburg, Ebola Zaire, Ebola Sudan, and Ebola Ivory Coast which are believed to be endemic to Africa, and Ebola Reston which putatively originates in the Philippines [2,4]. The viruses have come to be known particularly for their propensity to cause fatal hemorrhagic disease of humans with person-to-person spread, but they vary in pathogenicity from Ebola Reston which has been associated only with asymptomatic human infection, to Ebola Zaire which has caused epidemics with fatality rates of 77% to 88% [3,4]. All of the viruses appear to be highly pathogenic for subhuman primates and outbreaks of disease have occurred in Europe and North America in monkeys imported from Africa and the Philippines, sometimes with spread of infection to humans [4]. Contact with the tissues of dead subhuman primates is also known to have served as a source of infection for humans on at least two occasions in Africa [2,8]. Nevertheless, the lethality of the viruses for subhuman primates has been interpreted to indicate that, like humans, the animals constitute incidental victims of infection, and are not true reservoir hosts [4]. The source of the filoviruses in nature remains unknown, but in some instances it was established that bats roosted in buildings or a cave visited or frequented by people who subsequently presented as primary cases of infection in outbreaks of disease in Africa. It is known that one patient was bitten or stung by what is presumed to have been an arthropod 7 days prior to developing Marburg disease [4]. Informal speculation has included the

suggestion that filoviruses may be plant viruses, perhaps even involving transmission by arthropod vectors.

The fact that outbreaks of filovirus infections have been recognized erratically, in widely separated geographic locations at unpredictable intervals, has hampered the search for the source of virus in nature, and comparatively few field investigations have been reported [4]. Following the recognition of the 1995 epidemic of Ebola fever in Kikwit, Zaire, teams of scientists coordinated by the Centers for Disease Control and Prevention, Atlanta, and the U.S. Army Medical Research Institute of Infectious Diseases, Fort Detrick, collected large numbers of vertebrate and arthropod specimens during June, July, and August 1995. Because evidence indicated that the outbreak had actually started in January 1995, it was considered possible that the virus was no longer circulating in its natural hosts in the vicinity of Kikwit by the time ecologic studies were undertaken. Thus, to allow for the possibility that the filoviruses manifest seasonal activity in their natural hosts, a team from the National Institute for Virology (NIV) in South Africa visited Kikwit in January 1996, to trap wild vertebrates and arthropods in the sites investigated by the other teams in mid-1995. Testing of the field material is a lengthy process, and no filoviruses have been detected so far. We decided to narrow the search by performing pathogenicity studies with Ebola virus in representatives of different classes and orders of living things, including vertebrates, invertebrates, and even plants. The underlying assumptions were that if a group of species is either refractory or hypersusceptible to the virus, members of the taxon are unlikely reservoir hosts of the virus, whereas members of taxa capable of circulating virus for prolonged periods without becoming ill are suspected reservoirs.

The strain of Ebola Zaire virus used in the experiments, Zaire-95, had been isolated from the blood of a patient in the 1995 epidemic in Kikwit and designated as the prototype strain of the outbreak. Stocks were prepared from virus at pass level 4 in Vero V76 cell cultures by freeze-thawing infected cultures, clarifying the supernatant culture fluid at 3,000g, and storing it in small volumes at  $-70^{\circ}\text{C}$ . Virus titers were determined by fluorescent focus assay in 8-chamber slide cultures as described for rabies [6], except that Vero cells were used, and cultures were stained with immune mouse ascitic fluid followed by fluorescein-labeled anti-mouse immunoglobulin and read on day 3 to 5 postinoculation to detect infected foci. Inoculum volumes of 10 $\mu\text{L}$  of 10-fold serial dilutions of stock virus or tissue suspensions were adsorbed to cultures, and titers were expressed as fluorescent focus-forming units (FFU) per mL.

One-month-old potted seedlings of 33 varieties of 24 species of weeds and crop plants used in plant virology (Table 1), plus colonized leafhoppers, were obtained from Dr. G. Pietersen of the Plant Protection Research Institute (PPRI) at Rietondale, Pretoria, South Africa. The plants were selected because collectively they could provide culture substrates for a broad spectrum of the known viruses of economically important plants. They were kept under suitable lighting for 10 hours each day and watered as necessary to sustain growth in the laboratory. Pigeons were obtained from the South African Institute for Medical Research in Johannesburg; 1- to 3-month-old hatchling snakes from the Transvaal Snake Park, Midrand; cockroaches from a colony at the Bureau of Standards in Pretoria; and *Mastomys natalensis* and NIH mice from colonies at NIV. All other animals used in the

studies (Table 2) were collected in the Kruger National Park, South Africa, with the permission of the National Parks Board as part of a long-standing research project on hemorrhagic fever viruses. The animals were translocated from the park under permit from the Department of Veterinary Field Services, and the experiments were conducted in a biosafety level 4 containment laboratory at NIV with clearance from the Department of Agriculture, Conservation and Environment of Gauteng Province, and the Animal Ethics Committee of NIV. All animals were fed a diet similar to their natural diets and were provided with fresh drinking water daily.

**Table 1. Plants Experimentally Inoculated with Ebola Virus**

Scientific name	Common name
<i>Arachis hypogaea</i>	Groundnut
<i>Beta vulgaris</i>	Beetroot
<i>Chenopodium amaranticolor</i>	Goosefoot weed
<i>Chenopodium quinoa</i>	Goosefoot weed
<i>Cucumis sativus</i>	Cucumber
<i>Cucurbita pepo</i>	Pumpkin
<i>Glycine max</i> <sup>a</sup>	Soybean
<i>Gomphrena globosa</i>	Weed
<i>Gossypium hirsutum</i>	Cotton
<i>Lupinus albus</i>	Lupin
<i>Lycopersicon esculentum</i>	Tomato
<i>Macroptilium atropureum</i>	Siratro bean
<i>Nicotiana benthamiana</i>	Wild tobacco
<i>Nicotiana clevelandii</i>	Wild tobacco
<i>Nicotiana glutinosa</i>	Wild tobacco
<i>Nicotiana langsdorfi</i>	Wild tobacco
<i>Nicotiana rustica</i>	Wild tobacco
<i>Nicotiana tabacum</i>	Tobacco
<i>Phaseolus vulgaris</i> <sup>a</sup>	French bean
<i>Pisum sativum</i>	Green pea
<i>Triticum aestivum</i>	Wheat
<i>Vicia faba</i>	Broadbean
<i>Vigna unguiculata</i> <sup>b</sup>	Cowpea
<i>Zea mays</i>	Maize

<sup>a</sup> Five varieties inoculated.

<sup>b</sup> Two varieties inoculated.

Vertebrates were inoculated subcutaneously with 0.1 mL of stock virus diluted 1:10 in cell culture medium, and back titration of the inoculum indicated that each animal received a dose of 40,000 or  $10^{4.6}$  FFU virus. Invertebrates were inoculated with undiluted stock virus and received approximately 1.0  $\mu$ L containing 4,000 or  $10^{3.6}$  FFU of virus, except for leafhoppers which received about 0.3  $\mu$ L inoculum. The arthropods were inoculated intrathoracically by a previously described method [5], except for ants and millipedes, which were inoculated into the hemocoel through the membranous integument between tergites. To simulate mechanical transmission, undiluted stock virus mixed with Carborundum powder was rubbed gently with cotton buds onto two leaves on each of the plant varieties on experiment; to simulate vector-borne transmission, a second plant of each type was inoculated with 1.0  $\mu$ L virus suspension into the phloem of the stem, using the same apparatus as for arthropods. A third plant of each type served as control. Plants were observed daily and those that wilted or developed apparent lesions were harvested; some material was fixed in 2.5% glutaraldehyde in buffer for examination by electron microscopy, and the rest was stored at  $-70^{\circ}\text{C}$  for virus assay. The process of embedding, sectioning, and examining the plant tissues by electron microscopy was performed by H.J. van Tonder of PPRI. Animals were sacrificed and assayed for virus content either in pools or individually, before inoculation and at intervals postinoculation (Table 2). Serum and pooled visceral organs were tested separately, and individual organ samples were preserved at  $-70^{\circ}\text{C}$  and in Formalin fixative for more detailed study later. Urine and feces samples were tested on some occasions. Materials for virus assay were prepared as 10% suspensions in culture medium, and in parallel with attempts to titrate infectivity, 0.1-mL volumes were inoculated onto Vero cell monolayers in 25-cm<sup>2</sup> flasks, which were subcultured thrice at weekly intervals before specimens were recorded as negative.

Thirteen plants either wilted or developed lesions on the leaves ascribed to mechanical injury during the inoculation process, but no infectivity could be recovered from the triturated tissues, and no evidence of virus infection was observed by electron microscopy. All animal experiments (Table 2) were performed in parallel on a single occasion except for a second experiment with insectivorous bats (*Tadarida* spp.). Insectivorous bats had difficulty adapting to a laboratory diet, and consequently 10 of 18 died in the first experiment. Although virus was recovered from the blood and organs of some, no histopathologic lesions were observed, and no evidence of widespread infection was detected by immunohistochemical technique [9]. All of the bats that died had not been eating well, and hence more insectivorous bats (*T. pumila*) were collected from the same colony as used previously and adapted to a diet of mealworms over a 3-week period before inoculation. The bats in the second experiment received the same dose of virus as the previous group, and no deaths occurred before the 12 animals in the study, including nine that were kept 21 to 28 days, were sacrificed (Table 2). None of the other vertebrates died, although some of the ants, cockroaches, and spiders died, possibly from desiccation as a result of injury during inoculation.

## **Table 2. Results of Experimental Infection of Various Animals with Ebola Virus**

Single user license provided by AAMU. Further copying, networking, and distribution prohibited.

Species	Common name	Pool size	Day Postinfection																
			1	2	3	4	5	6	7	8	9	10	11	12	13	14	21	28	
<i>Columba livia</i>	Domestic pigeon	1	0/1 <sup>a</sup>	0/1	0/1	0/1	0/1	0/1	0/1	0/1	0/1	0/1	0/1	0/1	0/1	0/1	0/1	0/2	0/2
<i>Hyperolius viridiflavus</i>	Painted reed frog	2	0/1	0/1	0/1	0/1	0/1	0/1	0/1	0/1	0/1	0/1	0/1	0/1	0/1	0/1	0/1	0/1	0/2
<i>Bufo regularis</i>	Common toad	1				0/1			0/1					0/1				0/1	
<i>Chiromantis xerampelina</i>	Grey tree frog	1						0/1		0/1								0/1	0/1
<i>Hemidactylus mabouia</i>	Tropical house gecko	1	0/1	0/1	0/1	0/1	0/1	0/1	0/1	0/1	0/1	0/1	0/1	0/1	0/1			0/1	
<i>Lamprophis fuliginosus</i>	Brown house snake	1	0/1	0/1	1/1	0/1	0/1	0/1	0/1	0/1	1/1	0/1	0/1	1/1	0/1	0/1	0/1	0/2	0/2
<i>Geochelone pardalis</i>	Leopard tortoise	1							0/1		0/1		0/1						0/1
<i>Kinixys belliani</i>	Hinged-back tortoise	1								0/2		0/2		0/2					0/2
<i>Tadarida condylura</i>	Angola free-tailed bat	1				1/2	1/2				2/2	1/1			1/1				
<i>Tadarida pumila</i>	Little free-tailed bat	1	1/1	1/1	1/1		0/1	1/2	0/2	0/1		1/1	1/1	1/1	0/1	1/1	0/1	0/4	0/5
<i>Epomophorus wahlbergi</i>	Wahlberg's epauletted fruit bat	1		0/1		1/1		1/1	1/1	1/1		1/1	1/1	1/1				1/1	0/1
<i>Mastomys natalensis</i> ss	Multimammate mouse	1	0/3	0/3	0/3	0/3	0/3	0/3	0/3	0/3	0/3	0/3	0/3	0/3	0/3	0/3	0/3	0/3	0/3
<i>Mus musculus</i>	NIH mouse	1		1/1	0/1	0/1				1/1	0/1	1/1	0/1	0/1			0/1	0/2	
<i>Periplaneta americana</i>	American cockroach	2	0/1	0/1	0/1	0/1	0/1	0/1	0/1	0/1									
<i>Austria agallia</i>	Leafhopper	50																	0/1
<i>Messor barbarus capensis</i>	Myrmicine ant	5			0/1			0/1		0/1									
<i>Stegodyphus dumicola</i>	Social spider	2	0/1	1/1	0/1	0/1	0/1	0/1	0/1	0/1								1/1	
<i>Alloporus</i> sp.	Millipede	1	0/1	0/1	0/1	0/1	0/1	0/1	0/1	0/1	0/1								
<i>Achatina</i> sp.	African landsnail	1			0/1			0/1											0/1

<sup>a</sup> Virus isolations/pools tested.

The virus replicated in bats: titers of  $10^{4.6}$  to  $10^{7.0}$  FFU/mL were recorded in sera and titers of  $10^{2.0}$  to  $10^{6.5}$  FFU/mL in pooled viscera of fruit bats. In addition, virus was recovered from the feces of a fruit bat on day 21 postinoculation. Virus was also recovered on a few occasions from snakes, and NIH mice and spiders (Table 2), but this was at a minimal titer of  $10^{1.0}$  FFU/mL and could represent residual infectivity from inoculation. Histopathologic and immunohistochemical investigations [7] have thus far been limited to some sets of the bat organs, and the only virus antigen detected was present in the endothelial cells of lung tissue of a bat sacrificed on day 8 postinoculation. Four insectivorous bat sera collected on day 28 postinoculation and four samples from noninfected bats were tested for Ebola virus antigen or antibody by enzyme-linked immunoassay [1] using conjugated chicken anti-rodent immunoglobulin; antibody was found in only one of the infected bats.

Although they do not provide conclusive evidence that bats are potential reservoir hosts of filoviruses or that the other animals are not, the findings demonstrate the validity of the experimental approach to the search for the source of the viruses in nature. If it can be shown, for instance, that a further two to three species of birds of widely divergent orders or families are refractory to the virus, birds can be accorded low priority in field studies, and efforts can be concentrated on animals capable of circulating virus. Even if evidence is obtained that certain animals become infected in the field, it would remain desirable to study the nature of the infection they undergo in the laboratory to determine whether they can harbor virus for prolonged periods and transmit it to other animals. Additionally, materials derived from the experiments can be used to develop, test, and perfect methods for



detecting infectious virus, viral antigen, nucleic acid, or antibodies in different species, and to establish whether or not demonstrable immune response develops in ostensibly refractory animals. There are no accepted methods for demonstrating antibody in many wild vertebrates; anti-bat immunoglobulin is being produced as part of the present project.

The two tadarids studied here, and many other bats, have a distribution that overlaps the sites of known filovirus outbreaks in Africa, and the migratory habits of some species would facilitate dissemination of virus [7]. The presence of virus in lung tissue implies that respiratory or oral spread of infection could occur in the confined spaces where bats roost, and isolation of virus from feces suggests the existence of mechanisms for transmission of infection to other animals. However, much remains to be learned about the nature of the infection in bats, including the sites of virus replication, persistence, and the behavior of the virus in further genera and species.

# References

1. Ksiazek TG, Rollin PE, Jahrling PB, Johnson E, Dalgard DW, Peters CJ. Enzyme immunosorbent assay for Ebola virus antigens in tissues of infected primates. *J Clin Microbiol* 1992;30:947-50.
2. Le Guenno B, Formenty P, Wyers M, Gounon P, Walker F, Boesch C. Isolation and partial characterization of a new strain of Ebola virus. *Lancet* 1995;345:1271-4.
3. Muyembe T, Kipasa M. Ebola haemorrhagic fever in Kikwit, Zaire. *Lancet* 1995;345:1448.
4. Peters CJ, Sanchez A, Rollin PE, Ksiazek TG, Murphy FA. Filoviridae: Marburg and Ebola viruses. In: Fields BN, Knipe DM, Howley PM, editors. *Field's Virology*, 3rd edition. Philadelphia: Lippincott-Raven. 1996. p. 1161-76.
5. Rosen L, Gubler D. The use of mosquitoes to detect and propagate dengue viruses. *Am J Trop Med Hyg* 1974;23:1153-60.
6. Smith JS, Yager PA, Baer GM. A rapid tissue culture test for determining rabies neutralizing antibody. In: *Laboratory Techniques in Rabies*. Geneva: World Health Organization. 1973. p. 354-7.
7. Smithers RHN. Chiroptera. In: *The Mammals of the Southern African Region*. Pretoria: University of Pretoria. 1983. p. 51-137.
8. World Health Organization. Outbreak of Ebola haemorrhagic fever in Gabon officially declared over. *Wkly Epidemiol Rec* 1996;71:125-6.
9. Zaki SR, Greer PW, Goldsmith CS, et al. Ebola virus hemorrhagic fever: pathologic, immunopathologic and ultrastructural studies. *Lab Invest* 1996;74.

- 
1. Adapted with permission from a previously published article: Swanepoel R, et al. Experimental inoculation of plants and animals with Ebola virus. *Emerging Infectious Diseases* 1996;2(4):321-5.



# Emergence of Rodent-borne Viruses: Arenavirus and Hantavirus Infection in South America

Delia A. Enria, M.D., M.P.H. and Silvana C. Levis, Ph.D.

*Instituto Nacional de Enfermedades Virales Humanas "J. Maiztegui", Argentina*

Rodent-borne viruses represent good examples of the zoonotic pool which are currently responsible for, or have the potential for, emerging human infections. During the last five decades, South America has experienced the appearance of four hemorrhagic fevers due to the arenaviruses Junin, Machupo, Guanarito, and Sabia. Other arenaviruses not associated with human diseases (Piritai, Latino, Oliveros, Tacaribe, Pichinde, Flexal, Parana, and Amapari) have also been found circulating among South American sigmodontine rodents. More recently, Hantavirus Pulmonary Syndrome (HPS) was described in the United States and now constitutes the main clinical form of human infections with hantaviruses prevalent in the Americas. Six South American countries (Argentina, Brazil, Bolivia, Paraguay, Uruguay, and Chile) have reported isolated cases and outbreaks of HPS, and many new hantaviruses have been identified, including Caño Delgadito, Río Mamoré, Laguna Negra, Juquitiba, Andes, Lechiguanas, Hu39694, Maciel, Pergamino, Bermejo, and Orán.

The elucidation of the factors responsible for the origin and spread of these illnesses is important to understand emerging diseases and is the first step for designing effective control and management strategies.

# Introduction

Hantaviruses and arenaviruses are naturally-occurring viruses of rodents, and human infections with them are among classic examples of zoonotic introductions. During the past 50 years, South America has experienced the emergence of different hemorrhagic fevers shown to be caused by arenaviruses. In the last decade more is being learned about rodent-borne viruses through the emergence of hantavirus-related illnesses.

In this article, we will review the most relevant aspects of arenavirus and hantavirus infections in South America.

# South American Arenaviral Hemorrhagic Fevers

## *Historical Perspective*

In the 1950s, a new disease was recognized in the humid pampa, the richest farming region of Argentina, and was named Argentine Hemorrhagic Fever (AHF) [3]. The etiologic agent, Junin virus, was isolated in 1958 [94]. Since then, annual outbreaks of the disease have been registered without interruption, with more than 25,000 cases reported to date (Figure 1). Since its emergence, the most striking characteristic of AHF has been the steady and progressive geographic extension of the endemic region, which has continued until the present (Figure 2) [71,73]. The initially high case-fatality rate of the disease, reaching almost 50%, was markedly reduced at first with adequate supportive measures, and more significantly with the availability of a specific effective treatment: immune plasma [28,72]. The development in the 1980s of a live attenuated Junin virus vaccine (Candid 1) with a proven efficacy against the disease is currently changing the classic epidemiological pattern and is opening the possibility for achieving disease control [4,5,74,75,77].

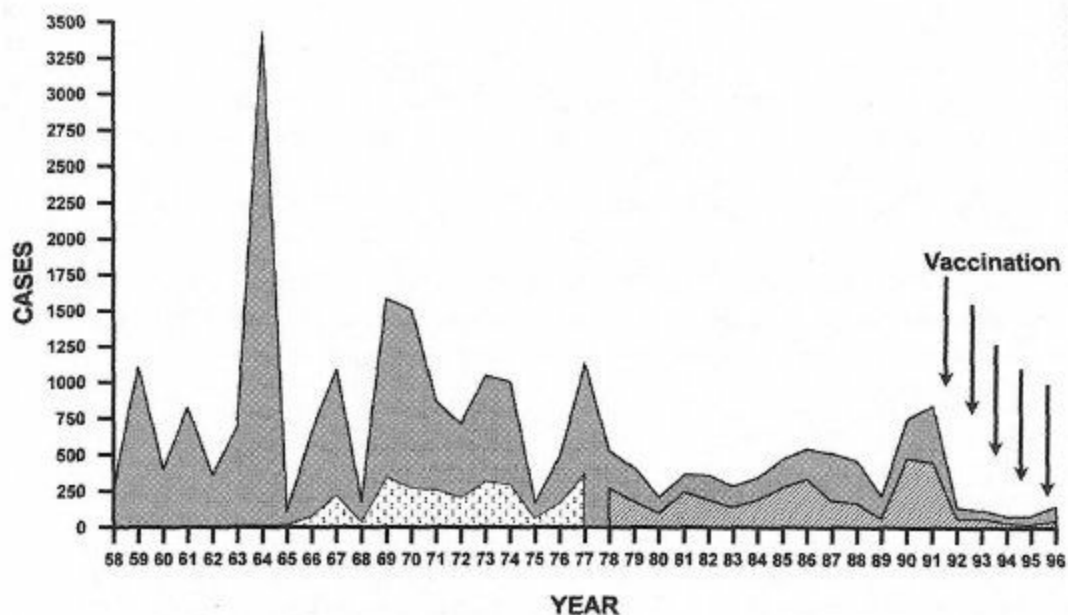

**Figure 1.** Annual distribution of AHF. Laboratory confirmation of cases is available since 1965. Annual outbreaks of the disease have been registered every year without interruption. Since 1991, vaccination with Candid 1 vaccine of the high-risk adult population resulted in a significant decline in cases.

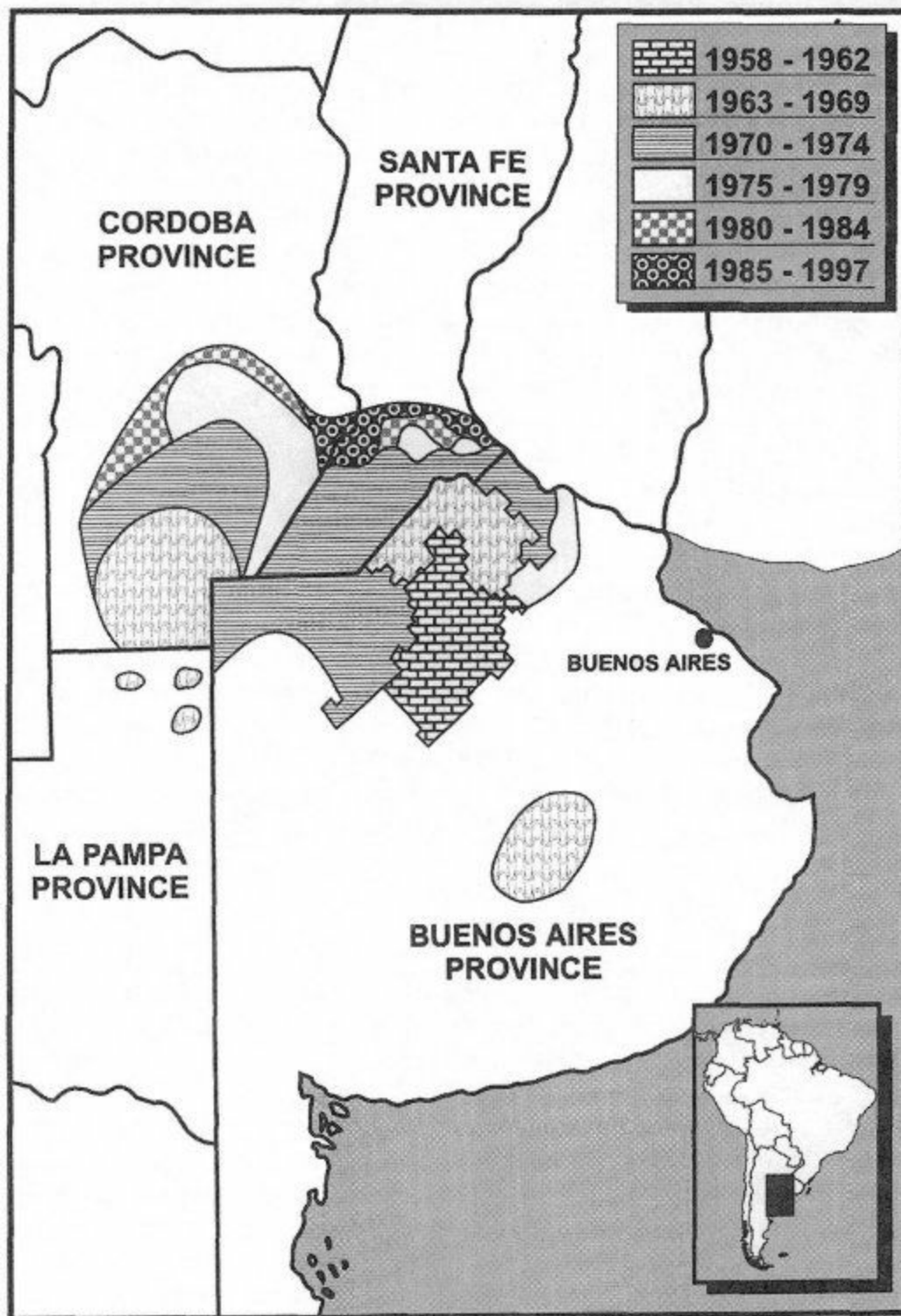

**Figure 2.** Geographic extension of AHF endemic area. Since the emergence of AHF in the 1950s, there has been an approximate 10-fold expansion in the endemic region. Current rodent studies indicate the possibility of a northward extension and re-emergence in historical areas.

Bolivian Hemorrhagic Fever (BHF) was originally described in 1959 emerging in the tropical plains of the Beni Department in eastern Bolivia, and by 1964 the etiologic agent, Machupo virus, was isolated [50]. During the 1960s, BHF became a major public health problem when it caused explosive community-wide outbreaks with substantial case-fatality rates. During the 1963-64 epidemic in San Joaquín, Beni Department, 637 cases were

reported with 113 deaths in a town of only 3,000 inhabitants [51]. These epidemics led to intensive and effective rodent control efforts during the 1960s and '70s, and community-wide outbreaks ceased [80]. Since the middle 1970s, there have been no reported cases of BHF, although sporadic illness is believed to still occur. In 1993, a lethal case confirmed as BHF marked the beginning of what was considered the re-emergence of the disease after 20 years of silence. This re-emergence included an outbreak in 1994 involving seven members of a family, six of whom died [55,56].

In 1989 a severe hemorrhagic fever was recognized by clinicians in Portuguesa State, Venezuela. At first, approaches centered on etiologic investigations of dengue viruses, but a new virus named Guanarito was identified as the cause of the disease. Guanarito virus was shown to belong to the Arenaviridae, and the new disease was named Venezuelan Hemorrhagic Fever (VHF) [108]. One hundred sixty-five cases of VHF were reported through January 1997, with two periods of continuous activity: the first between September 1989 and August 1992 with the detection of 93 cases, and the second between September 1996 and at least January 1997 with 63 cases reported. During the intervening 3-year period there were only nine recognized cases [23].

A single case of naturally-acquired disease due to the Arenavirus Sabia was reported in January 1990 [17]. There have also been two documented laboratory infections [6].

### *Etiology*

The Arenaviridae family is currently comprised of at least 19 recognized members, 15 of which are distributed throughout the Americas (Figure 3). They are enveloped viruses, with a genome consisting of two single-stranded RNA molecules. They derive their name from the Latin "Arenosus", referring to the characteristic morphology when viewed by thin section electron microscopy due to the presence of host cell ribosomes inside virions. The prototype species of this family is lymphocytic choriomeningitis virus (LCM), a worldwide-distributed virus. Viruses from this family are characterized by a spherical, somewhat pleomorphic morphology, with a diameter of about 110 to 130 nm (range, 50 to 300 nm). They bud from the host cell membrane, generally contain 20 nm particles that are cellular ribosomes, and have a lipid envelope [8,35,36,38,76,103].

Arenavirus genome consists of two single-stranded RNA molecules, designated L (large) and S (small), with lengths of approximately 3.4 and 7.2 kilobases, respectively. Two genes are encoded on each RNA in an ambisense orientation. The S RNA encodes for the nucleoprotein N and for the glycoprotein precursor (GPC). The viral glycoproteins of the envelope G1 and G2 are derived by posttranslational cleavage of the precursor GPC. The L RNA encodes for the L protein, with transcriptase replicase activity and for the Z protein, a small structural protein with a zinc-binding domain [7].





**Figure 3.** New World arenaviruses. Arenaviridae family currently comprises 19 recognized members divided into two groups. Old World arenaviruses includes LCM, Lassa, Mopeia, Mobala and Ippy.

New World arenaviruses (or Tacaribe complex) are shown, together with their main putative reservoirs. Those arenaviruses pathogenic for humans are also indicated:

- \* Junin: Argentine Hemorrhagic Fever
- \* Machupo: Bolivian Hemorrhagic Fever
- \* Guanarito: Venezuelan Hemorrhagic Fever
- \* Sabia: Hemorrhagic Fever (Brazil)

Arenaviruses were first divided by serologic assays (complement fixation and immunofluorescent tests) into two groups: the Old World and the New World or Tacaribe complex, with a low-level antigenic relatedness between the two groups. Two antigenic

subgroups were defined with the New World arenaviruses. The first group contains Amapari, Junin, Latino, Machupo, and Tacaribe viruses, while the second group is comprised of Flexal, Parana, Pichinde, and Tamiami [11,76,122].

Analysis of genetic sequence data provides a more complete picture of arenavirus relationships. As suggested by serological studies, phylogenetic analyses demonstrated that the Old World and the New World arenaviruses occupied two distinct clades. New World arenaviruses comprise three evolution lineages designated A, B, and C. The four agents (Junin, Machupo, Guanarito, and Sabia) responsible for hemorrhagic fevers are contained in lineage B. This clade also contains Amapari and Tacaribe viruses, which have not been reported to cause hemorrhagic fever [9].

## *Epidemiology*

### ***Geographic Distribution***

AHF is endemic to the humid pampa, the most fertile farming region in Argentina. The most striking epidemiologic characteristic of AHF is its progressive geographic extension (Figure 2). In 1958, cases were limited to an area of approximately 16,000 km<sup>2</sup>, with a population at risk estimated to be 270,000 inhabitants. In 1963, cases of AHF were confirmed in the Southeast region of the province of Córdoba, and between 1964 and 1967 new areas were detected in the province of Buenos Aires. Cases began to appear later in the south of the Santa Fe province [71,73]. At present, the endemo-epidemic region covers an area of approximately 150,000 km<sup>2</sup>, with a population at risk estimated to be more than 3,000,000 persons. Geographic extensions in the latest period have been smaller than those seen immediately after its discovery, suggesting an autolimitation in the extension of the endemic area. Nevertheless, rodent studies indicate the possibility of a northward extension [83]. Since 1958, annual outbreaks of AHF have been registered without interruption with more than 25,000 cases reported. Laboratory confirmation of cases has been routinely performed since 1965 (Figure 1). AHF has a focal distribution that could be related to the patchy spatial distribution of the infected reservoir of Junin virus, *Calomys musculus* [84,107]. Annual incidence rates within the endemic area may be as low as 1/100,000, but in the areas of highest activity the incidence in the general population reaches 140/100,000 with the rate as high as 355/100,000 among adult males. The incidence of AHF also varies in different years. In general, it is highest during the initial 5- to 10-year period in newly-infected areas and later declines. Nevertheless, cases continue to be reported from the older locations. This epidemiologic pattern has been modified since 1992 through vaccination of a high-risk population (Figure 1).

BHF is found in the Beni Department in Bolivia, which comprises an area of approximately 120,000 km<sup>2</sup>. This is a tropical region located in the north of Bolivia, with a rural population of approximately 16,000 inhabitants [55,58,97].

VHF was first recognized in the Guanarito area of the Portuguesa State in Venezuela. It is currently estimated that the endemic region encompasses the area 9,000 km<sup>2</sup> southeast and southwest of Portuguesa State and the nearby region of Barinas State. The total

population of this area is 300,000 persons, with 142,000 living in rural areas [23,97,111].

The geographic distribution of Sabia virus is unknown. The natural case, however, is thought to have acquired the disease in Sao Paulo State, Brazil [17].

### ***Seasonal Distribution***

Although cases of AHF can be seen throughout the year, epidemics occur predominantly during the autumn and winter seasons, with a peak incidence in the month of May coincident with the major harvesting season in Argentina [69].

BHF also tends to be a seasonal disease, with more cases occurring in the dry season, at the peak of agricultural activity [51,58].

VHF cases have been observed throughout the year, but epidemics appear to have a seasonal peak in November to January, also coinciding with maximum agricultural activity in the endemic region [23].

### ***Risk Factors***

AHF is four times more prevalent among males than females, and occurs more often among rural workers (90%) than in urban populations. Children under 14 years of age comprise about 10% of cases annually, but disease is uncommon in those younger than 4 years of age, and exceptional under the age of 2 [69]. The seasonal distribution of the illness and the prevalence among adult male rural workers reflect occupational exposure of humans and the habitats of the rodent hosts of Junin virus, which increase in density during late summer and autumn, coincident with the time of important field labor. AHF emerged in the 1950s affecting men working in agricultural-related occupations, mainly those harvesting crops by hand. With the mechanization of agricultural practices that took place in the 1960s and '70s, workers driving tractors or other machines in the field now comprise the highest group at risk.

Sporadic cases of BHF have affected adult males living in rural areas. Family and community clusters of BHF affecting both sexes and all age groups have been registered, however, and were related to invasion of towns or villages by rodents [51,80].

The highest population at risk for VHF are adult male agricultural workers, although children and adults of both sexes have been reported to suffer from the disease [23].

### ***Transmission***

#### ***Maintenance of Viruses Among Rodent Host Populations***

All currently known arenavirus pathogens for humans are rodent viruses. Each arenavirus can infect many species of rodents, but in every site there is always one species that due to its density and prevalence, as well as characteristics of the infection, behaves as the principal reservoir [15].

*C. musculus* has been identified as the principal reservoir of Junin virus, although the virus has also been isolated from the organs and body fluids of *Calomys laucha* and

*Akodon azarae*, and occasionally from *Mus musculus*, *Necromys benefactus*, and *Oligoryzomys flavescens* [106,107].

Based on IFA serological studies and identification of virus isolated, Guanarito virus was initially thought to have two reservoirs, *Sigmodon alstoni* and *Zygodontomys brevicauda*. Later studies have shown that *S. alstoni* isolates belong to Pirital virus, while those from *Z. brevicauda* are prototype Guanarito virus [34,36,111].

The Machupo virus is hosted by *Calomys callosus* [51,58,116], while the reservoir for the Sabia virus remains unknown.

Viral transmission within reservoir populations may be via horizontal or vertical routes [15]. The role of vertical transmission has been questioned for Junin and Machupo viruses. Increased mortality and fetal wastage with decreasing growth has been observed for *C. musculinus* rodents infected with Junin virus [115]. Vertical transmission of the Machupo virus would likely have a severe effect on host reproductive fitness. Reservoir rodent females experimentally inoculated at birth with Machupo virus became chronically infected and sterile [51,116]. Several lines of evidence indicate that both Junin and Machupo viruses can be maintained within rodents via a horizontal route. Experimental studies with *C. musculinus* rodents infected with Junin virus, and with *C. callosus* rodents infected with Machupo virus, have shown two types of responses. Some of the animals developed an acute disease with production of antibodies and clearance of the virus. The remaining animals developed a persistent infection, with absent or low titers of antibodies, chronic viremia, and elimination of virus in urine, feces, and saliva [114,116]. The chronically-infected host is usually asymptomatic and shows normal movement through its environment, where it comes into contact with other animals. Field studies of natural populations have demonstrated that infection with Junin virus among *C. musculinus* is more frequent among males than females and is positively correlated with age and the presence of wounds and scars [83,84].

Patterns of maintenance for Guanarito virus in *Z. brevicauda* rodents are not clear as yet, but seem to be different than that described for either the Junin or Machupo models since horizontal viral transmission has an apparent negative effect on reproductive fitness [34,97,111].

### ***Transmission to Humans***

The exact mechanism of viral transmission from rodent to humans is unknown, although there is strong evidence to support aerosol transmission. Inhalation by humans of aerosolized virus from rodent excreta is considered the main mode of transmission, but viral entry through conjunctival or other mucous membranes, ingestion, or skin abrasions is also possible.

AHF is usually not contagious, although human-to-human transmission can occur. Viremia is present in AHF patients throughout the acute febrile period, and Junin virus has occasionally been isolated from oral swabs, urine, and breast milk [69,105]. One possible exception to the low risk of person-to-person transmission is the infection of some women who are thought to have acquired the illness through intimate contact with their convalescing

husbands [10].

Person-to-person transmission with Machupo virus has been documented in both familial and nosocomial settings, and is likely to occur via direct contact with infectious body fluids. Transmission through intimate contacts during convalescence has also been documented [51,55,56,96]. Interhuman transmission or nosocomial infections have not been observed with VHF [23].

### *Ecological Dynamics*

The emergence of all South American Hemorrhagic Fevers can be connected to man-made ecological perturbations. The emergence of AHF in the 1950s is hypothesized to have resulted from human alterations to the habitat related to agricultural practices. Such changes in the environment are reported to have favored the population growth of the principal reservoir of Junin virus, *C. musculus*. The Argentine pampas, and in particular the AHF endemic area, currently exist largely as a patchwork of intensively cultivated agricultural fields, dissected by relatively more stable linear habitats of roadsides, fence lines, and railroad right of ways. The area is inhabited by an assemblage of six common species of small rodents which include five sigmodontines, *C. musculus*, *C. laucha*, *A. azarae*, *N. benefactus*, and *O. flavescens*, and the murid *M. musculus* [24,82,83,107]. *C. musculus* and *C. laucha* are relatively small-bodied, opportunistic, and highly fecund species which readily invade disturbed habitats. *C. musculus* is a habitat generalist. Although it is most frequently captured in stable linear habitats, it often forages into mature and post-harvest crop fields where it supplements its diet with grain from corn and soy beans [26]. It is rarely captured in or around human dwellings. The other three species, *N. benefactus*, *A. azarae*, and *O. flavescens* occur almost exclusively in the more stable linear habitats. *Necromys* and *Akodon* are large-bodied species, are less fecund, and display behavioral dominance over the two species of *Calomys*. Although *Calomys* may be very numerous and reach plague levels in agricultural districts, the rodent community of the preagricultural pampas grassland is thought to have been dominated by *Akodon*, *Necromys*, and *Oligoryzomys* [24].

Environmental factors controlling fluctuating rodent populations have been the subject of considerable study and controversy. One factor which very likely contributes to cyclical patterns in the incidence of AHF is climate, acting through its influence on rodent reservoir density. On the Argentine pampas, seasonal rainfall and temperature patterns have been documented as having an important influence on rodent populations. Cool, wet winters and hot, dry summers likely result in decreased populations, while warm or dry winters and cool or rainy summers contribute to increases in rodent densities [21]. It has also been hypothesized that changes in major crops, burning or cutting of linear habitat refuges, and variation in the intensity of insecticide and herbicide use according to economic conditions has contributed to shifts in disease incidence [24,73].

One common factor connected to the emergence of both BHF and VHF was conversion of the forest to cultivated fields. In Beni Department, *C. callosus* lives in habitats at the forest-grassland edge, but has also adapted to living in villages and houses on high ground

in seasonally-inundated areas. Within the VHF endemic area, rodent species carrying Guanarito virus are commonly captured in crop-field borders and roadside habitats, but they are rarely captured in peridomestic habitats [51,97,111].

Descriptions of the geographic limits of pathogenic South American arenaviruses are defined mainly by the occurrence of human disease and not by the distribution of the viruses. The main reservoir of Junin virus is found in most of central and northwestern Argentina, and its distribution largely exceeds the area considered endemic for AHF. A similar situation exists with *C. callosus*, which is found in eastern and southwestern Brazil, Bolivia, Paraguay, and northern Argentina. *Z. brevicauda* is distributed from southwest Costa Rica through Panamá to Perú and east-central Brazil [92,101]. A gradient of infection has been described in Junin virus surveys of *Calomys* across the boundaries of the AHF endemo-epidemic region. The prevalence of Junin virus infection in *C. musculinus* is highest in endemic regions and is reported to be nonexistent or low outside the endemic zone [83]. Junin virus, however, has been isolated from rodents in areas without human cases in the last 15 years and from areas where the disease has not yet been reported, indicating the possibility of new expansion of the endemic area and the re-emergence in areas currently considered historical [37].

Junin virus infection of *C. musculinus* has a patchy spatial distribution. Reasons for this particular arrangement are unclear and immunologic mechanisms have been involved. Moreover, within the AHF endemic area, other viruses have been isolated or genetically identified in small rodents. These include arenaviruses such as LCM and Oliveros, and hantaviruses such as Lechiguanas, Maciel, and Pergamino [2,8,65,66]. Similar situations have been observed in Bolivia and Venezuela. Latino virus is found in southern Beni province where *C. callosus* is considered the principal host [97,116]. Río Mamoré is a hantavirus recovered from a small rodent captured in Bolivia [46]. In Venezuela, Guanarito virus has been found in the same area as the arenavirus, Pirital, and the hantavirus, Caño Delgadito [36,109]. These findings suggest the possibility of other interactions that may be important to the dynamics of rodent infections, but have yet to be explored.

## *Human Diseases*

### ***Clinical Characteristics***

Because of their close similarities, all South American Hemorrhagic Fevers are presented here as a single entity [23,69,97]. The incubation period is usually between 6 to 14 days. The onset of illness is insidious, and characterized by chills, malaise, anorexia, headache, myalgias, and moderate hyperthermia (38° to 39°C). After several days, further constitutional, gastrointestinal, neurological, and cardiovascular signs and symptoms appear with low back ache, retroorbital pain, nausea or vomiting, epigastric pain, photophobia, dizziness, constipation, or mild diarrhea being common. An almost constant absence of productive cough or nasal congestion is helpful in distinguishing the initial symptoms of South American Hemorrhagic Fevers from those of acute respiratory infections. During the first week of illness, physical examination reveals flushing of the face, neck, and upper chest; conjunctival congestion and periorbital edema may also occur. The gums are also

congested and may bleed spontaneously or under slight pressure. An enanthem characterized by petechiae and small vesicles is almost invariably found over the soft palate. Most patients have cutaneous petechiae in the axillary regions, upper chest, and arms. Lymph nodes become enlarged, particularly in the laterocervical regions. There are no signs of pulmonary abnormalities but relative bradycardia and orthostatic hypotension are common. Hepatomegaly and splenomegaly are generally not observed and jaundice is very rare. At the end of the first week of evolution, oliguria and different degrees of dehydration occur. Neurological signs are very common and patients may be irritable, lethargic, and have a fine tremor of the hand and tongue. Moderate ataxia, cutaneous hyperesthesia, and a decrease in deep tendon reflex and muscular tonicity are present. In females, mild-to-moderate metrorrhagia is constantly present, and in some cases, is the first sign of the disease. Patients with VHF frequently complain of a sore throat among their initial symptoms.

During the second week of illness, 70 to 80% of patients begin to improve. In the remaining 20 to 30%, severe hemorrhagic or neurologic manifestations, shock, and superimposed bacterial infections appear 8 to 12 days after symptom onset. Profuse bleeding may occur in the form of hematemesis, melena, hemoptysis, epistaxis, hematomas, metrorrhagia, or hematuria. The severe neurological manifestations generally begin with mental confusion, marked ataxia, increased irritability, and intense tremors; these are followed by delirium, generalized convulsions, and coma. Acute renal failure is uncommon, but may occur in terminal cases or after prolonged periods of shock and is secondary to acute tubular necrosis. Superimposed bacterial infections, such as pneumonia and septicemia, can also complicate these diseases. They also appear during the second week, and their diagnosis may be delayed because they are usually not accompanied by leukocytosis.

Patients have a prolonged convalescence. Temporary hair loss is common and many patients have asthenia, irritability, and memory changes which are transitory and gradually disappear. During convalescence, 10% of the AHF cases treated with immune plasma develop a late neurological syndrome (LNS). This LNS appears after a symptom-free period, differs from the neurological manifestations of the acute period of AHF, and is characterized by febrile symptoms and manifestations from the cerebellar trunk [29,72].

Only a single, naturally-acquired infection with Sabia virus has been identified. It resembled the other South American Hemorrhagic Fevers except for extensive liver necrosis and jaundice [17]. Of interest, BHF case-patients from a nosocomial outbreak which occurred at high altitudes experienced jaundice and high mortality, but the reason for this was not determined [96,97].

Clinical laboratory studies are helpful in establishing an early clinical diagnosis. During the acute phase, there is progressive leukopenia and thrombocytopenia, with white blood cell counts falling to  $1,000-2,000/\text{mm}^3$  and platelet counts to  $50,000-100,000/\text{mm}^3$ . Sedimentation rate is normal or decreased. Almost invariably, there is proteinuria, with urinary sediment containing hyaline-granular casts, round cells with cytoplasmic inclusions, and hematuria. Serum creatinine and urea are normal or increased in proportion to dehydration and shock in severely ill patients. SGOT, CPK, and LDH elevations are common

but mild, and hyperbilirubinemia or hyperamylasemia are rare. During the acute illness, cerebrospinal fluid is normal, even in patients with severe neurologic disease. Changes are regularly detected in the cerebrospinal fluid of AHF cases with a LNS, however, and include a moderate increase in the number of cells and the presence of antibodies against Junin virus [29].

### ***Differential Diagnosis***

During the first week of illness, the clinical manifestations of South American Hemorrhagic Fevers are nonspecific and can be confused with several acute febrile conditions. Among the infectious diseases, differential diagnoses include typhoid fever, hepatitis, infectious mononucleosis, leptospirosis, Hantavirus Pulmonary Syndrome, malaria, yellow fever, dengue, and rickettsial infections. Diseases presenting with hematologic or neurologic alterations such as intoxications, rheumatic diseases, and blood dyscrasias should also be considered. All South American Hemorrhagic Fevers resemble one another. In the respective endemic areas or in case-patients with a history of travel to these specific geographic regions, the detection of an undetermined febrile syndrome with leukopenia and thrombocytopenia is suspicious.

### ***Etiologic Diagnosis***

Viremia occurs throughout the acute febrile period, and the viruses can be isolated from blood and from the lymphoid tissues of fatal cases. Isolation can be performed in Vero cells or similar cell culture monolayers. Cocultivation of peripheral blood mononuclear cells improves the sensitivity of the method in AHF [1]. Viral isolations also can be performed in guinea pigs or suckling mice [97]. Serologic diagnosis can be made by complement fixation, indirect immunofluorescence, neutralization, and ELISA [95]. Due to its sensitivity and specificity, ELISA is currently the method of choice. In organs obtained from autopsy, diagnosis can be also performed by immunohistochemistry. RT-PCR has also been successfully applied in AHF and can play a role in establishing etiologic diagnosis in patients who died before the appearance of the specific antibodies [68]. Recent BHF cases have been diagnosed by antigen and IgM antibodies detected by ELISA [56].

### ***Pathology and Pathophysiology***

Gross pathology and light microscopy are generally similar among different arenavirus infections, and reveal nonspecific alterations consisting of widespread congestion, edema, and hemorrhages [14,27,124]. In AHF, ultrastructural and immunohistochemical studies revealed characteristic intracellular lesions that were more prominent in lymphatic tissues and coincident with the presence of Junin virus antigens [20,39,70]. Several studies suggest that lymphatic tissues are the main sites of viral replication, with lymphocytopenia the consequence of lymphocyte depletion. Morphological studies of the bone marrow indicate that an acute and transient arrest of hemopoiesis occurs with bone marrow hypocellularity, but is without permanent hematological sequelae in patients who overcome the disease



[99].

The lack of histological lesions to explain disordered organ function and death is a common characteristic of all arenavirus infections, particularly hemorrhagic fevers. This has led to the idea that arenaviruses induce altered cell function without overt histopathology. In South American Hemorrhagic Fevers, the pathophysiology seems to be the result of direct viral action in contrast to the mouse models of LCM infection. Several studies failed to demonstrate immune complexes, complement activation, or disseminated intravascular coagulation as relevant pathogenic mechanisms in AHF [22]. Mediators released or activated as a result of the virus-cell interactions such as lymphokines, vasoactive mediators, and proteolytic enzymes may explain the alterations seen in terminal cases. In AHF, bleeding itself seems to be a joint outcome of thrombocytopenia, abnormal platelet function induced by a plasma component, and alterations in blood coagulation with fibrinolysis activation. Hemostatic abnormalities include prolongation of APTT; low levels of factors VIII and IX; increased values of factor V, von Willebrand factor (vWf), and fibrinogen; and mild decreases in antithrombin III and plasminogen. Endothelial cell involvement is also suspected, since Junin virus replicates in cultured endothelial cells, a feature supported in human disease by increased vWf levels [41,42,87].

AHF is also characterized by an acute transitory immunodeficiency. There is a lag phase in the humoral immune response, with antibodies appearing the second week of illness coincident with the recovery of patients. Cell-mediated immunity is also depressed, and there are marked changes in the T cell subpopulations which return to normal values in early convalescence [29,30,112].

Very high titers of endogenous interferon (IFN) have been demonstrated in serum samples of AHF patients during the acute phase. The levels of IFN decreased abruptly after the transfusion of immune plasma [62]. Interferon levels are significantly higher in fatal cases [63]. Another study suggests an association between histocompatibility antigens and the severity of AHF [104].

## ***Treatment***

Treatment is available for AHF, specifically the transfusion of immune plasma within the first 8 days from onset of symptoms [72]. This treatment reduces the case-fatality rate from 15 to 30% to less than 1%, and is now standardized based on the amount of neutralizing antibodies to Junin virus [28]. Immune plasma is not beneficial to patients when it is initiated more than 8 days after symptom onset [30].

For the other South American Hemorrhagic Fevers, ribavirin is the suggested treatment and should be used unless a proven alternative therapy is available [6,56]. Ribavirin may also prove to be useful in treatment of AHF [30].

Other treatment consists of adequate hydration, symptomatic measures, and proper management of the neurologic alterations, blood loss, shock, and superimposed infections. The use of steroids is not indicated. Medications should be given orally or intravenously. Intramuscular and subcutaneous injections are contraindicated because of the risk of hematomas and life-threatening infections.

## ***Clinical and Laboratory Precautions***

Universal precautions are adequate for the care of patients with AHF and when handling samples from potentially-infected persons. When aerosols or splashes are likely to occur, however, the use of a biologic safety cabinet is indicated. Viral cultures should be manipulated at biosafety level-3 (BSL-3) containment facilities. Outside the area where these viruses are indigenous, they should be handled in BSL-4 containment laboratories. All personnel working in relation to Junin virus should be immune; Candid 1 vaccine is available for the prevention of AHF for seronegative persons.

## ***Control and Preventive Measures***

In Bolivia, rodent control has been successful in reducing epidemics occurring in towns, but sporadic cases still occur after rural exposure or contact with a case-patient [55,56,58,80].

For AHF, rodent control or the control of human contact with infected rodent populations is impractical. Therefore, several efforts have been directed toward obtaining a vaccine against the disease. A live attenuated Junin virus vaccine (Candid 1) has been developed through an international cooperative project involving the Government of Argentina, the Pan American Health Organization, the United Nations Development Program, and the United States Army Medical Research and Development Command [4,5]. After completion of preclinical testing, the safety and immunogenicity of this vaccine were established in more than 300 volunteers immunized between 1985 and 1988 in Frederick, Maryland (United States) and Pergamino, Argentina [74,77-79].

Between 1988 and 1990, a prospective, randomized, double-blind, placebo-controlled trial in 6,500 human volunteers from 41 localities of the endemic area clearly established the efficacy of the vaccine in preventing AHF. Candid 1 efficacy was estimated to be 95.5% [75]. In 1991, vaccination campaigns were initiated to provide coverage to high-risk populations. Because Candid 1 is an orphan drug, however, there are limited quantities and restrictions to the geographic area and populations targeted by this vaccination were required. A total of 161,237 persons, selected on the basis of their frequent exposure and/or rural residence in areas of high incidence, were vaccinated through 1997. Although the definite impact of vaccination is still under evaluation, epidemic outbreaks in the last several years have been the lowest registered since the disease was first described (Figure 1). Seven cases of AHF have been detected among vaccinated individuals; all had mild forms of the disease with a favorable outcome.

Ongoing studies continue to reinforce previous observations concerning the safety and immunogenicity of Candid 1 vaccine. The persistence of the specific immune response is still under evaluation, but current studies have shown that 8 years after vaccination, more than 85% of the vaccinees continue to have neutralizing antibodies against Junin virus. Calculated vaccine effectiveness on target high-risk populations is 99.2% (Confidence Interval = 98.3 to 99.6%). Candid 1 may also be effective in the prevention of BHF, as suggested by preclinical studies, but the vaccine did not cross-protect against infection with Guanarito or Sabia viruses in experimental studies [97].

# Hantavirus Pulmonary Syndrome in South America

Since the initial description of Hantavirus Pulmonary Syndrome (HPS) in the United States and the discovery of the etiologic agent, multiple hantaviruses have been identified in South America. HPS epidemics as well as sporadic cases have occurred in Argentina, Brazil, Paraguay, Uruguay, Bolivia, and Chile. It is now thought that more human hantavirus infections, as well as new viruses, will be discovered in the Americas in direct concordance with our expertise in locating them.

## *Historical Perspective*

Hantavirus activity in South America has been observed since the 1980s. Several studies performed during that decade showed the circulation of these viruses among wild and laboratory rodents and provided serologic evidence for human infections in Brazil, Argentina, Bolivia, and Uruguay [59,60,93,117,118].

Following the 1993 outbreak in the United States, HPS was diagnosed in six South American countries. Brazil reported six cases, and a new virus named Juquitiba was identified in a cluster of cases in 1993 [48,125]. In 1995, an outbreak of HPS occurred in Paraguay and the investigation identified 23 laboratory-confirmed HPS cases. The etiologic agent was named Laguna Negra virus and was isolated from the putative rodent reservoir, *C. laucha* [49,121].

In Argentina, a strategy for identification of acute cases was initiated in 1993. Active surveillance was performed among patients with a clinical diagnosis of AHF, leptospirosis, and Acute Respiratory Distress Syndrome (ARDS) of unknown etiology. Three endemic areas for the disease have been described in this country: the northern, central, and southern regions. The northern region currently includes Salta and Jujuy provinces. Since the early 1980s, physicians in Orán (Salta province) described an unusual presentation of ARDS cases occurring in clusters, which were known as Distress of Orán. Multiple efforts to establish the etiology of the disease were unsuccessful. In the early 1990s, it was discovered that part of the cases grouped under the name of Distress of Orán were caused by *Leptospiras interrogans* [19]. After 1993, it was demonstrated that under that syndrome there were also cases of HPS [64]. A cluster of HPS occurred in the city of El Bolsón, Río Negro province, Southern Argentina in March 1995. Andes virus was subsequently genetically identified and implicated as the cause of the illness [64,67]. Another outbreak of HPS occurred in 1996 in the same region, with 18 cases occurring within 3 months. Two persons that had not visited the area where the outbreak occurred had contact with HPS case-patients and developed HPS, including an emergency room physician in Buenos Aires. In total, there were five case-patients who were physicians, three of whom had been responsible for treating patients with HPS. For the first time, this outbreak suggested the possibility of person-to-person transmission of Andes hantavirus [31].

As of February 6, 1998, a total of 135 cases have been confirmed in Argentina and seven different genotypes of hantaviruses were found circulating in this country. Uruguay, Bolivia, and Chile have also reported sporadic cases of HPS since 1995. The last outbreak

occurred in Chile in 1996. The possibility of some type of interhuman transmission was also suggested in this outbreak [13].

## *Etiology*

Hantaviruses are lipid-enveloped, spherical viruses of 80 to 110 nm in diameter that belong to the family Bunyaviridae. This family comprises five genera, and hantaviruses are unique among them because they are rodent-borne while all of the others are arthropod-borne. Hantaviruses consist of a RNA tri-segmented genome, with the large (L) segment of approximately 6500 nucleotides in length, the middle (M) segment of approximately 3600 to 3800 nucleotides in length, and the small (S) segment of approximately 1700 to 2100 nucleotides in length. The L segment encodes a viral polymerase, the M segment encodes G1 and G2 envelope glycoproteins, and the S segment encodes the N nucleocapsid protein [109].

The prototype virus of the family is Hantaan virus, which takes its name from the Hantaan river in Korea where it was first isolated [61]. Closely-related agents include Seoul, Dobrava-Belgrado, and Puumala viruses. Except for the Seoul virus, which is thought to have a worldwide distribution related to its rodent reservoir, *Rattus norvegicus*, all of the viruses occurred throughout the Eurasian landmass, and are responsible for a wide spectrum of human diseases known as hemorrhagic fever with renal syndrome (HFRS). HFRS has been reported almost exclusively outside the Americas, with an annual number of cases ranging from 150,000 to 200,000. The first hantavirus isolated in the Americas was Prospect Hill, and thus far has not been associated with human disease [109].

In 1993, a new disease was recognized in the United States which presented mainly as respiratory insufficiency. The etiologic agent was discovered to be a novel agent among hantavirus genus, and was named Sin Nombre virus [57,91]. After the isolation of Sin Nombre virus, many other hantaviruses have been identified circulating in the Americas. Genetic characterization of hantavirus precedes viral isolation and there are many genetically-characterized viruses that have not yet been isolated. Other viruses recognized in North America include New York 1, Black Creek Canal, and Bayou [43,44,53,54,88,100,102,110].

In South America, several hantaviruses have been identified including: Río Mamoré virus from Bolivia, Caño Delgadito virus from Venezuela, Juquitiba from Brazil, and Laguna Negra from Paraguay [46,109]. In Argentina, seven different genotypes of hantaviruses have been identified, four of which have been associated with human disease. These include Andes, Lechiguanas, Hu 39694, and Orán. The other three recognized genotypes from rodents, referred to as Maciel, Pergamino, and Bermejo, have not been associated with human disease (Figure 4) [65-67].



**Figure 4.** South American hantaviruses. Currently identified South American hantaviruses and known putative reservoirs are shown.

\* Hantaviruses that have been associated with human diseases.

## Epidemiology

More than 400 cases of HPS have been reported from eight countries of the Americas. Up through February 1998, South American countries that have reported HPS include Argentina (135 cases), Paraguay (34 cases), Chile (29 cases), Brazil (6 cases), Uruguay (2 cases), and Bolivia (1 case). In Argentina, three endemic areas for HPS have been described:

1) Northern region, including the Salta and Jujuy provinces. Cases in this area were associated with the Orán genotype.

2) Central region, including Santa Fe, Buenos Aires, and Córdoba provinces and is coincident with AHF endemic zone. Cases in this area were produced by Lechiguanas and Hu39694 genotypes.

3) Southern region, including the Río Negro, Chubut, and Neuquén provinces. Cases in

this region were caused by the Andes virus.

As in North America, HPS in South America has affected persons of all ages and both sexes, although a higher prevalence has been observed among males (almost 80%). Most infections have occurred in rural settings. The epidemiology of HPS in South America, however, is somewhat different than that in the United States, with seroprevalences among human populations varying greatly from region to region and reported to be as high as 40% among central Paraguayan Indians. A larger number of pediatric cases have been seen in Chile and Argentina compared to the United States [13,98].

## *Transmission*

### ***Maintenance of Viruses Among Rodent Host Populations***

Murid Rodents (order *Rodentia*, family *Muridae*) are the natural host and reservoirs of hantaviruses. As with the arenaviruses, the pattern of association between hantaviruses and their hosts has consistent features: 1) each virus is usually associated with a single species of rodent host; and 2) infection in the rodent host is chronic and asymptomatic and involves long-term shedding of virus into the environment via urine, feces, and saliva. At present, 11 hantaviruses have been identified in South America. Figure 4 presents the hantaviruses together with their respective putative reservoirs. Field studies strongly suggest that transmission of hantaviruses within reservoir populations occurs horizontally [85,123]. Antibodies to hantavirus were found more frequently among males than females, and were positively correlated with age and the presence of wounds and scars, suggesting that aggressive encounters among adult males may be important mechanisms of transmission. Vertical transmission has not been convincingly demonstrated. Experimental studies of infection of the different rodent hosts with hantaviruses have not yet been completed.

### ***Transmission to Humans***

Transmission of hantaviruses from rodents to humans is thought to occur primarily through the inhalation of aerosolized rodent excreta from infected hosts. Infectious aerosols may be produced as urine is shed or can result from disturbing contaminated soil, litter, or nesting materials. The possibility of transmission by the bite of an infected rodent has also been suggested.

Person-to-person transmission has been documented in an outbreak of HPS caused by the Andes virus in southern Argentina in 1996. The outbreak was unique because of the low rodent population density [31,119]. Epidemiologic and genetic studies confirmed the hypothesis of interhuman transmission. The possibility of person-to-person transmission was also suggested in the 1997 epidemic in Chile which was also caused by the Andes virus [13]. In central and northern endemic regions of Argentina and in North America, there has been no evidence of person-to-person transmission [113,120].

## ***Ecological Dynamics***

It is thought that all hantaviruses came from a common ancestor, and that they have been evolving together with the species of rodents they infect. A widespread infection with hantaviruses is found within three subfamilies of the family Muridae: the *Murinae* (Old World rats and mice), the *Sigmodontinae* (New World rats and mice), and the *Arvicolinae* (the voles). This pattern suggests that these viruses have been associated with Murine rodents since at least before these three subfamilial lineages diverged, perhaps 20 million years ago. The geological age of this family dates to the Oligocene period in North America and the Pliocene period in South America [92,101]. Another implication of the hypothesis of coevolution of these viruses and their rodent hosts, apart from their antiquity, is the wide potential diversity of hantaviruses among all the rodent species of these subfamilies.

Murid rodents are currently found in a wide variety of habitats, depending upon the particular region where they are distributed. Most rodents probably live less than 2 years, however, high reproductive potential of certain species sometimes results in large numerical increases. Peak population of rodents is then followed by a sudden crash in numbers when food supplies in a given area are exhausted. Many outbreaks of HPS have been associated with increases in rodent population densities. These temporary increases in population density may sometimes be related to unusual climatic events that result in temporary but highly favorable conditions. The resulting high population densities likely result in increased contact among rodents, a greater potential for viral transmission, and thus a higher proportion of virus-shedding rodents. The 1993 HPS outbreak in the United States was associated with El Niño influences on the climate, favoring population increases in *Peromyscus maniculatus* [16,57,85]. A similar situation was documented for the 1997 southern Chile outbreak [13]. In the southern Andes, mast seeding (or mass fruiting) have been long associated with mouse outbreaks. Mast seeding is a population phenomenon that refers to a massive reproductive output and subsequent death of long-lived plants. This cyclical phenomenon affecting bamboo plants genus *Chusquea* was documented in southern Chile, and several instances of exponential population growths of *O. longicaudatus* (a reservoir of Andes virus) were reported [89].

The range of infection of the rodent hosts is not known for many South American hantaviruses. As with arenaviruses, infection of reservoir population is patchy. Thus, hantavirus antibody prevalences vary from a high of 16% to a low of 0% in other areas. Also, this prevalence of infection is variable on a temporal scale. Such changes in infection prevalence could be related to host population dynamics.

Long-term studies of the dynamics of infection, many of them currently ongoing, are needed for a better understanding of the ecologic aspects behind these diseases. Experimental animal models similar to those developed for arenaviruses would be extremely valuable in the comprehension of the dynamics of hantavirus-related infection.

## *Human Diseases*

### ***Clinical Characteristics***

Clinical presentation of hantavirus diseases in South America has been seen primarily as HPS. A case definition for HPS developed by the Centers for Disease Control and

Prevention was useful throughout South America in detecting cases. This definition considers a probable case of HPS to be a febrile illness (fever greater than 38.3°C) in a previously healthy person characterized by unexplained adult respiratory distress syndrome or bilateral interstitial pulmonary infiltrates, with respiratory compromise requiring supplemental oxygen, or an unexplained illness resulting in death in conjunction with an autopsy examination demonstrating noncardiogenic pulmonary edema without an identifiable specific cause of death.

The incubation period is thought to be between 1 to 6 weeks followed by a prodromal phase of approximately 3 to 5 days duration which is characterized by fever, headache, and myalgias. Gastrointestinal symptoms, such as vomiting, diarrhea, or abdominal pain, and dizziness are often present. Cough and tachypnea are generally absent during the initial phase, but appear later and herald the progression to the cardiopulmonary phase of HPS. Physical examination typically reveals tachypnea, tachycardia, hypotension, and rales upon respiratory auscultation. Once the cardiopulmonary phase begins, pulmonary edema rapidly develops and almost all cases require supplemental oxygen and often mechanical ventilation. South American cases have shown some different features, including conjunctival congestion and head and neck suffusion. Hemorrhagic and renal compromise have been reported among Argentine cases in the central region caused by Lechiguanas virus, a situation also described in Chile. Though rare in SNV-associated HPS, renal involvement has also been reported for Bayou and Black Creek Canal virus-associated HPS in North America [25,45,81,86,93].

Clinical laboratory findings include leukocytosis with a marked left shift and percentages of white blood cell precursors as high as 50%. Immunoblasts (atypical lymphocytes) are frequently present. Thrombocytopenia, hemoconcentration, mildly elevated hepatic transaminases, marked elevations in serum lactate dehydrogenase, and moderately prolonged partial thromboplastin time are also found.

HPS has a characteristic radiological evolution beginning with minimal changes representative of interstitial pulmonary edema and rapidly progresses to alveolar edema with severe bilateral involvement [52]. Hemodynamic profiles in HPS patients include a normal pulmonary wedge pressure, a decreased cardiac index, and an elevated systemic vascular resistance indicative of cardiac suppression [40].

### ***Differential Diagnosis***

During the prodromal phase it is difficult to differentiate HPS from other acute febrile conditions. Once the cardiopulmonary phase begins, however, differential diagnoses include leptospirosis, psittacosis, rickettsial infections, influenza, histoplasmosis, atypical bacterial and viral community-acquired pneumonias, pneumonic plague, meningococemia and other sepsis syndromes, legionellosis, and illnesses caused by arenaviruses, flaviviruses, and other bunyaviruses.

### ***Etiologic Diagnosis***

Single user license provided by AAMI. Further copying, networking, and distribution prohibited.

Etiologic diagnosis is achieved by serology, showing the presence of ELISA IgM specific



antibodies or seroconversion by IgG; by the presence of a positive RT-PCR for hantavirus RNA; or by demonstration of viral antigens in tissues by immunohistochemistry.

### ***Pathology and Pathophysiology***

Reported pathological findings of South American cases revealed alterations similar to North American cases, with large, serous pleural effusions and severe pulmonary edema [18,32,90]. Light microscopy studies of the lungs in HPS case-patients have shown mild-to-moderate numbers of hyaline membranes, normal pneumocytes, and scarce neutrophils. The absence of a marked pulmonary response of acute inflammatory cells distinguishes HPS from most other infectious pneumonias. Atypical mononuclear cells were consistently seen in the periarteriolar and red-pulp regions of the spleen, and in the paracortex of the lymph nodes. Some patients also had atypical mononuclear cells in the hepatic triads. In a series of 12 incomplete autopsies analyzed in Argentina, other lesions were found such as myocarditis, hepatic necrosis, and renal lesions predominantly in the medullar and thrombosis of the small vessels. Some alteration of the megakaryocytes of bone marrow were also seen. It is not clear yet if these alterations would be consistently observed. In a report of cases caused by the Andes virus, more dense infiltration of the alveolar interstices, more prominent hyaline membrane, and less airspace fibrin exudation than those seen in North American cases were also described [32].

The pathogenesis of HPS has been associated with a profound abnormality in vascular permeability. Viral antigens, although widely distributed in practically all organs, are primarily detected in capillary endothelial cells, and particularly in pulmonary capillary endothelial cells.

### ***Treatment***

There is no specific effective therapy for New World hantavirus infections. Ribavirin has been effective in the treatment of HFRS, but its efficacy in the treatment of HPS is unclear [47]. One of the problems that arises in determining the efficacy of ribavirin is the difficulty in initiating therapy early in the prodromal phase. A placebo-controlled clinical trial is currently ongoing in the United States. In Argentina, a protocol for evaluating ribavirin early in the course of the disease has been approved. This study was designed with the consideration that cases presented in clusters in this country. In this study, ribavirin will be evaluated in high-risk contacts of confirmed HPS cases who develop a febrile syndrome of unknown etiology within 4 weeks of contact.

In the absence of a proven effective therapy, the treatment of HPS is based on careful fluid management, hemodynamic monitoring, and ventilatory support. The use of steroids is also being examined among South American patients.

### ***Clinical and Laboratory Precautions***

Universal precautions should be followed in the care of these patients and when handling samples from potentially infected persons. In South America, respiratory isolation

procedures for hospitalized patients may be warranted if the Andes virus is believed to be the etiologic agent and if local conditions permit. Biosafety level 2 (BSL-2) facilities and BSL-2 practices are recommended for laboratory handling of sera from persons potentially infected with the agents of HPS. When aerosols or splashes are likely to occur, however, use of a biologic safety cabinet is indicated. Potentially-infected tissue samples should be handled in BSL-2 facilities in accordance with BSL-3 practices. Cell-culture virus propagation should be carried out in BSL-3 containment facilities in accordance with BSL-3 practices. Large scale growth of virus, including preparing and handling viral concentrates, should be performed in BSL-4 containment facilities.

### *Control and Preventive Measures*

Control of wild rodent populations is impracticable and probably undesirable. Strategies for disease prevention are directed to minimizing contact with rodents and their excreta, especially in the domestic and peridomestic settings. The effectiveness of these strategies has not yet been proven [12].

# Conclusions

'Old' viruses are the causes of 'new' diseases all over the world, particularly in South America. The emergence of arenaviral hemorrhagic fevers in the past 50 years, the discovery of several circulating arenaviruses, and the similar emergence of HPS and the identification of a great number of new hantaviruses, signals the potential threat of these agents in this continent. The large number of rodent species that inhabit the Americas suggests the possibility of the existence of many yet undiscovered arenaviruses and hantaviruses. These viruses may also cause human illnesses [33]. This reinforces the importance of continuous research in the area of rodent-borne viruses. The public health impact of the associated diseases in humans is sometimes minimized due to their low incidence, but the high case-fatality rates among young healthy people should remold the analysis.

The experience acquired with arenaviral hemorrhagic fevers should be considered when analyzing hantaviral infections. In this respect, AHF illustrates an excellent public health example. For this disease, we have an effective treatment that has allowed the case-fatality rate of the disease to be markedly reduced. It is foreseen that definite control of AHF would be achieved if enough Candid 1 vaccine were available to inoculate all of the at-risk population. It remains to be seen, however, if this experience can be repeated for other rodent-borne viruses, considering all of the difficulties that arise with low incidence zoonotic diseases both from a scientific and a financial viewpoint.

On the other hand, many topics regarding rodent-borne viruses remain unanswered and controversial. As an illustration, for the AHF model discussed we still lack a confirmed hypothesis in relation to the factors behind the emergence and progressive geographic extension of the disease. Long-term studies of the ecological dynamics would provide more adequate answers and proposals.

# References

1. Ambrosio AM, Enria DA, Maiztegui JI. Junin virus isolation from lympho-mononuclear cells of patients with Argentine Hemorrhagic Fever. *Intervirology* 1986;25(2):97-102.
2. Ambrosio AM, Feuillade MR, Gamboa GS, Maiztegui JI. Prevalence of Lymphocytic Choriomeningitis virus infection in a human population of Argentina. *Am J Trop Med Hyg* 1994;50(3):381-6.
3. Arribalzaga RA. Una nueva enfermedad epidémica a germen desconocido: hipertermia nefrotóxica, leucopénica y enantemática. *Día Médico* 1955;27:1204-10.
4. Barrera Oro JG, Eddy G. Characteristics of candidate live attenuated Junin virus vaccine. Fourth International Conference on Comparative Virology; 1982; Banf, Alberta, Canada. Abstract S4-10.
5. Barrera Oro JG, McKee KT. Towards a vaccine against Argentine Hemorrhagic Fever. *Bull Pan Am Health Organ* 1991;25:118-26.
6. Barry M, Russi M, Armstrong L, et al. Treatment of a laboratory-acquired Sabia virus infection. *N Engl J Med* 1995;333:294-6.
7. Bishop DHL. Arenaviridae and their replication. In: Fields BN, Knipe DM, et al., editors. *Virology*. 2nd ed. New York: Raven Press; 1990. p. 1231-43.
8. Bowen MD, Peters CJ, Mills JN, Nichol ST. Oliveros virus: a novel arenavirus from Argentina. *Virology* 1996;217:362-6.
9. Bowen MD, Peters CJ, Nichol ST. The filogeny of New World (Tacaribe complex) arenaviruses. *Virology* 1996;219:285-90.
10. Briggiler AM, Enria DA, Feuillade MR, Maiztegui JI. Contagio interhumano e infección clínica con virus Junin (VJ) en matrimonios residentes en área endémica de Fiebre Hemorrágica Argentina (FHA). *Medicina (Buenos Aires)* 1987;47(6):565.
11. Casals J, Buckley SM, Cedeno R. Antigenic properties of the arenaviruses. *Bull World Health Organ* 1975;52:421-7.
12. CDC. Hantavirus infection – southwestern United States: Interim recommendations for risk reduction. *MMWR Morb Mortal Wkly Rep* 1993;42;ii-13.
13. CDC. Hantavirus pulmonary syndrome. Chile. *MMWR Morb Mortal Wkly Rep* 1997;46:949-51.
14. Child PL, MacKenzie RB, Johnson KM. Bolivian Hemorrhagic Fever. A pathologic description. *Arch Path* 1967;83:434-45.
15. Childs JC, Peters CJ. Ecology and epidemiology of arenaviruses and their hosts. In: Salvato MS, editor. *The Arenaviridae*. New York: Plenum Press; 1993. p. 331-73.
16. Childs JE, Ksiazek TG, Spiropoulou CF, et al. Serologic and genetic identification of *Peromyscus maniculatus* as the primary rodent reservoir for a new hantavirus in the southwestern United States. *J Infect Dis* 1994;169:1271-80.
17. Coimbra TLM, Nassar ES, Burattini MN, et al. New arenavirus isolated in Brazil. *Lancet* 1994;343:391-2.
18. Conclusiones y recomendaciones del Primer Taller Interdisciplinario sobre Hantavirus, Buenos Aires 9 y 10 de diciembre de 1996. Ministerio de Salud y Acción Social de la Republica Argentina, editor. Buenos Aires, Argentina: ANLIS; 1997. p. 15.

19. Cortes J, Supaga ME, Cacace ML, et al. Síndrome Pulmonar por Hantavirus y Leptospirosis en Orán, Salta. I Congreso Argentino de Zoonosis. I Congreso Latinoamericano de Zoonosis; 1995; Buenos Aires.
20. Cossio P, Laguens R, Arana R, Segal A, Maiztegui J. Ultrastructural and immunohistochemical study of the human kidney in Argentine Hemorrhagic Fever. *Virchows Arch. A Path Anat and Histol* 1975;368:1-9.
21. Crespo JA. Relaciones entre estados climáticos y la ecología de algunos roedores de campo (cricketidae). *Revista Argentina de Zoogeografía (Buenos Aires)* 1944;41:137-44.
22. de Bracco MME, Rimoldi MT, Cossio PM, et al. Argentine Hemorrhagic Fever. Alterations of the complement system and anti-Junin virus humoral response. *N Engl J Med* 1978;299:216-21.
23. de Manzione N, Salas RA, Paredes H, et al. Venezuelan Hemorrhagic Fever: clinical and epidemiologic studies of 165 cases. *Clin Infect Dis* 1998;26:308-13.
24. de Villafañe G, Kravetz FO, Donadio O, et al. Dinámica de las comunidades de roedores en agroecosistemas pampásicos. *Medicina (Buenos Aires)* 1977;37:128-40.
25. Duchin JS, Koster FT, Peters CJ, et al. Hantavirus pulmonary syndrome: A clinical description of 17 patients with a newly recognized disease. *N Engl J Med* 1994;330:949-55.
26. Ellis BA, Mills JN, Childs JE, et al. Structure and floristics of habitats associated with five rodent species in an agroecosystem in central Argentina. *J Zoology*. In press 1998.
27. Elsner B, Schwarz ER, Mando OG, Maiztegui JI, Vilches AM. Pathology of 12 fatal cases of Argentine Hemorrhagic Fever. *Am J Trop Med Hyg* 1973;22:229-36.
28. Enria DA, Briggiler AM, Fernandez NJ, Levis SC, Maiztegui JI. Importance of dose of neutralizing antibodies in treatment of Argentine Hemorrhagic Fever with immune plasma. *Lancet* 1984;8397:255-6.
29. Enria DA, Damilano AJ, Briggiler AM, et al. Síndrome neurológico tardío en enfermos de Fiebre Hemorrágica Argentina tratados con plasma inmune. *Medicina (Buenos Aires)* 1985;45(6):615-20.
30. Enria DA, Maiztegui JI. Antiviral treatment of Argentine Hemorrhagic Fever. *Antivir Res* 1994;23:23-31.
31. Enria D, Padula P, Segura EL, et al. Hantavirus pulmonary syndrome in Argentina: Possibility of person-to-person transmission. *Medicina (Buenos Aires)* 1996;56:709-11.
32. Feddersen RM, Hjelle B, Bharadwaj B, Barclay CE, Samengo L. Microscopic pathologic findings and tissue distribution of viral antigen in Hantavirus Pulmonary Syndrome due to Andes virus. *Am J Trop Med Hyg* 1997;57(3):145.
33. Framptom JW, Lanser S, Nichols CR, Ettestad PJ. Sin Nombre virus infection in 1959 [letter]. *Lancet* 1995; 346:781-2.
34. Fulhorst CF, Tesh RB, Ksiazek TG, Peters CJ, Salas RA. Experimental infection of the cane mouse *Zygodontomys brevicauda* with Guanarito virus (Arenaviridae) [abstract]. *Am J Trop Med Hyg* 1994;51(3):8.
35. Fulhorst CF, Bowen MD, Ksiazek TG, et al. Isolation and characterization of Whitewater Arroyo virus, a novel North American arenavirus. *Virology* 1996;224:114-20.
36. Fulhorst CF, Bowen MD, Salas RA, et al. Isolation and characterization of Pirital virus,

- a newly discovered South American *arenavirus*. Am J Trop Hyg 1997;56:548-53.
37. Garcia J, Calderon G, Sabattini M, Enria D. Infeccion por virus Junin (VJ) de *Calomys musculinus* (Cm) en áreas con diferente situación epidemiológica para la Fiebre Hemorrágica Argentina (FHA). Medicina (Buenos Aires) 1996;56(5/2):624.
  38. González JP, Bowen MD, Nichol ST, Rico-Hesse R. Genetic characterization and phylogeny of Sabia virus, an emergent pathogen in Brazil. Virology 1996;221:318-24.
  39. González PH, Cossio PM, Arana RM, Maiztegui JI, Laguens RP. Lymphatic tissue in Argentine hemorrhagic fever. Arch Pathol Lab Med 1980;104:250-4.
  40. Hallin GW, Simpson SQ, Crowell RE, et al. Cardiopulmonary manifestations of hantavirus pulmonary syndrome. Crit Care Med 1996;24:252-8.
  41. Heller MV, Saavedra MC, Falcoff R, Maiztegui JI, Molinas FC. Increased tumor necrosis factor-alpha levels in Argentine Hemorrhagic Fever. J Infect Dis 1992;166(5):1203-4.
  42. Heller MV, Marta RF, Sturk A, et al. Early markers of blood coagulation and fibrinolysis activation in Argentine Hemorrhagic Fever. Thromb Haemost 1995;73:368-73.
  43. Hjelle B, Chavez-Giles F, Torrez-Martinez N, et al. Genetic identification of a novel hantavirus of the harvest mouse *Reithrodontomys megalotis*. J Virol 1994;68:6751-54.
  44. Hjelle B, Lee SW, Song W, et al. Molecular linkage of hantavirus pulmonary syndrome to the white-footed mouse, *Peromyscus leucopus*: Genetic characterization of the M genome of New York virus. J Virol 1995;69(12):8137-41.
  45. Hjelle B, Goade D, Torrez-Martinez N, et al. Hantavirus pulmonary syndrome, renal insufficiency, and myositis with infection by Bayou hantavirus. Clin Inf Dis 1996;23:495-500.
  46. Hjelle B, Torrez-Martinez N, Koster FT. Hantavirus pulmonary syndrome-related virus from Bolivia [letter]. Lancet 1996;347:57.
  47. Huggins JW, Hsiang CM, Cosgriff TM, et al. Prospective, double-blind concurrent, placebo-controlled clinical trial of intravenous ribavirin therapy of hemorrhagic fever with renal syndrome. J Infect Dis 1991;164:1119-27.
  48. Iversson LB, Travassos da Rosa A, et al. Human infection by hantavirus in southern and southeastern Brazil. Revista de Associacao Médica Brasileira 1994;40:85-92.
  49. Johnson AM, Bowen MD, Ksiazek TG, et al. Laguna Negra virus associated with HPS in western Paraguay and Bolivia. Virology 1997;238:115-27.
  50. Johnson KM, Wiebenga NH, MacKenzie RB, et al. Virus isolations from human cases of hemorrhagic fever in Bolivia. Proc Soc Exp Biol Med 1965;118:113-8.
  51. Johnson KM, Halstead SB, Cohen SN. Hemorrhagic fevers of Southeast Asia and South America: a comparative appraisal. Progr Med Virol 1967;9:105-58.
  52. Ketal LH, Williamson MR, Telepak RJ, et al. Hantavirus Pulmonary Syndrome (HPS): Radiographic findings in 16 patients. Radiology 1994;191:665-78.
  53. Khan AS, Spiropoulou CF, Morzunov S, et al. Fatal illness associated with a new hantavirus in Louisiana. J Med Virol 1995;46:281-6.
  54. Khan AS, Gavia M, Rollin PE, et al. Hantavirus pulmonary syndrome in Florida: Association with the newly identified Black Creek Canal virus. Am J Med 1996;100:46-8.
  55. Kilgore PE, Peters CJ, Mills JN, et al. Prospect for the control of Bolivian Hemorrhagic

- Fever. *Emerg Inf Dis* 1995;1:97-100.
56. Kilgore PE, Ksiazek TG, Rollin PE, et al. Treatment of Bolivian Hemorrhagic Fever with intravenous ribavirin. *J Infect Dis* 1997;24:718-22.
57. Ksiazek TG, Peters CJ, Rollin PE, et al. Identification of a new North American hantavirus that causes acute pulmonary insufficiency. *Am J Trop Med Hyg* 1995;52:117-23.
58. Kuns ML. Epidemiology of Machupo virus infection: II. Ecological and control studies of hemorrhagic fever. *Am J Trop Med Hyg* 1965;14:813-6.
59. LeDuc JW, Smith GA, Pinheiro FP, Vasconcelos PF, Rosa ES, Maiztegui JI. Isolation of a Hantaan-related virus from Brazilian rats and serological evidence of its widespread distribution in South America. *Am J Trop Med Hyg* 1985;34:810-5.
60. LeDuc JW, Smith GA, Childs JE, et al. Global survey of antibody to Hantaan-related viruses among peridomestic rodents. *Bull World Health Organ* 1986;64:139-44.
61. Lee H, Lee P, Johnson K. Isolation of the etiologic agent of Korean fever. *J Infect Dis* 1978;137:298-308.
62. Levis SC, Saavedra MC, Cécconi C, et al. Endogenous interferon in Argentine Hemorrhagic Fever. *J Infect Dis* 1981;149:428-33.
63. Levis SC, Saavedra MC, Ceccoli C. Correlation between endogenous interferon and the clinical evolution of patients with Argentine hemorrhagic fever. *J Interferon Res* 1985;5:383-9.
64. Levis SC, Briggiler AM, Cacace M, et al. Emergence of Hantavirus Pulmonary Syndrome in Argentina [abstract]. *Am J Trop Med Hyg* 1995;53(2 Suppl 233): Abstract 441.
65. Levis S, Rowe J, Morzunov S, Enria DA, St Jeor S. New hantaviruses causing hantavirus pulmonary syndrome in central Argentina. *Lancet* 1997;349:998-9.
66. Levis S, Morzunov S, Rowe J, et al. Genetic diversity and epidemiology of hantaviruses in Argentina. *J Infect Dis*. In press 1998.
67. Lopez N, Padula P, Rossi C, Lazaro ME, Franze-Fernandez MT. Genetic identification of a new hantavirus causing severe pulmonary syndrome in Argentina. *Virology* 1996;220:223-6.
68. Lozano ME, Enria DA, Maiztegui JI, Grau O, Romanowski V. Rapid diagnosis of Argentine Hemorrhagic Fever by reverse transcriptase PCR-based assay. *J Clin Microbiol* 1995;33(5):1327-32.
69. Maiztegui JI. Clinical and epidemiological patterns of Argentine Hemorrhagic Fever. *Bull World Health Organ* 1975;52:567-75.
70. Maiztegui JI, Laguens RP, Cossio PM. Ultrastructural and immunohistochemical studies in five cases of Argentine Hemorrhagic Fevers. *J Infect Dis* 1975;132:35-43.
71. Maiztegui JI, Sabbatini MS. Extensión progresiva del área endémica de Fiebre Hemorrágica Argentina. *Medicina (Buenos Aires)* 1977;37(3):162-6.
72. Maiztegui JI, Fernandez NJ, Damilano AJ. Efficacy of immune plasma in treatment of Argentine Hemorrhagic Fever and association between treatment and a late neurological syndrome. *Lancet* 1979;8154:1216-7.
73. Maiztegui JI, Feuillade MR, Briggiler AM. Progressive extension of the endemic area

- and changing incidence of Argentine Hemorrhagic Fever. *Med Microbiol Immunol* 1986;175:149-52.
74. Maiztegui JI, Levis S, Enria D, et al. Inocuidad e inmunogenicidad en seres humanos de la cepa Candid 1 de virus Junin. *Medicina (Buenos Aires)* 1988;48(6):660.
  75. Maiztegui JI, McKee KT, Enria DA, et al. Protective efficacy of a live attenuated vaccine against Argentine Hemorrhagic Fever. *J Infect Dis*. In press 1998.
  76. Martinez Peralta LA, Coto C, Weissenbacher MC. The Tacaribe complex: the close relationship between a pathogenic (Junin) and a nonpathogenic (Tacaribe) arenavirus. In: Salvato MS, editor. *The Arenaviridae*. New York: Plenum Press; 1993. p. 281-8.
  77. McDonald D, McKee K, Peters C, Feinsod F, Cosgriff T, Barrera Oro J. Initial clinical assessment of humans inoculated with live-attenuated Junin vaccine. VII International Congress of Virology; 1987; Edmonton, Canada.
  78. McKee KT, Barrera Oro JG, Kuehne AI, Spisso JA, Maland BG. Candid 1: Argentine Hemorrhagic Fever vaccine protects against lethal Junin virus challenge in rhesus macaques. *Intervirology* 1992;34:154-63.
  79. McKee KT, Barrera Oro JG, Kuehne AI, Spisso JA, Maland BG. Safety and immunogenicity of a live-attenuated Junin (Argentine Hemorrhagic Fever) vaccine in rhesus macaques. *Am J Trop Med Hyg* 1993;48:403-11.
  80. Mercado RR. Rodent control programmes in areas affected by Bolivian Haemorrhagic Fever. *Bull World Health Organ* 1975;52:691-6.
  81. Mertz GJ, Hjelle B, Bryan RT. Hantavirus infection. In: Schrier RW, editor. *Advances in Internal Medicine*. Chicago: Mosby Year Book Inc; 1997. p. 369-421.
  82. Mills JN, Ellis BA, McKee KT Jr, Maiztegui JI, Childs JE. Habitat associations and relative densities of rodent populations in cultivated areas of central Argentina. *J Mammology* 1991;72(3):470-9.
  83. Mills JN, Ellis BA, McKee KT Jr, et al. A longitudinal study of Junin virus activity in the rodent reservoir of Argentine Hemorrhagic Fever. *Am J Trop Med Hyg* 1992;47(6):749-63.
  84. Mills JN, Ellis BA, Childs JE, et al. Prevalence of infection with Junin virus in rodent populations in the epidemic area of Argentine Hemorrhagic Fever. *Am J Trop Med Hyg* 1994;51(5):554-62.
  85. Mills JN, Ksiazek TG, Ellis BA. Patterns of association with host and habitat: Antibody reactive with Sin Nombre virus in small mammals in the major biotic communities of the southwestern United States. *Am J Trop Med Hyg* 1997;56:273-84.
  86. Moleanar RL, Dalton C, Lipman HB, et al. Clinical features that differentiate hantavirus pulmonary syndrome from three other acute respiratory illnesses. *Clin Infect Dis* 1995;21:643-9.
  87. Molinas FC, Bracco MME, Maiztegui JI. Coagulation studies in Argentine Hemorrhagic Fever. *J Infect Dis* 1981;143:1-6.
  88. Morzunov SP, Feldmann H, Spiropoulou CF, et al. A newly recognized virus associated with a fatal case of hantavirus pulmonary syndrome in Louisiana. *J Virol* 1995;69:1980-3.
  89. Murua R, Gonzalez LE, Gonzalez M, Jofre YC. Efectos del florecimiento del arbusto



*Chusquea quila* Kunth (Poaceae) sobre la demografía de poblaciones de roedores de los bosques templados fríos del sur chileno. Boletín de la Sociedad de Biología, Concepción, Chile 1996;67:37-42.

90. Neffen EL, Pini NC, Enria DA, et al. Hallazgos histopatológicos e inmunohistoquímicos del primer caso de autopsia de Síndrome Pulmonar por Hantavirus (SPH) en la Argentina. V Congreso Latinoamericano de Medicina Tropical. V Congreso Cubano de Microbiología y Parasitología. II Congreso Cubano de Medicina Tropical. Congreso 60 Aniversario de IPK; 1997; Ciudad de la Habana, Cuba.
91. Nichol ST, Spiropoulou CF, Morzunov S, et al. Genetic identification of a hantavirus associated with an outbreak of acute respiratory illness. Science 1993;262:914-7.
92. Norwak RM. Walker's Mammals of the World. Vol. 2. Baltimore: The Johns Hopkins University Press; 1993.
93. Parisi MN, Enria DA, Pini NC, Sabattini MS. Detección retrospectiva de infecciones clínicas por hantavirus en la Argentina. Medicina (Buenos Aires) 1996;56:1-13.
94. Parodi AS, Greenway DJ, Rugiero HR, et al. Sobre la etiología del brote epidémico de Junin. Día Médico 1958;30:2300-1.
95. Peters CJ, Webb A, Johnson KM. Measurement of antibodies to Machupo virus by the indirect fluorescent technique. Proc Soc Exp Biol Med 1972;142:256-531.
96. Peters CJ, Kuehne RW, Mercado R, Le Bow RH, Spertzel RO, Webb PA. Hemorrhagic fever in Cochabamba, Bolivia. Am J Epidemiol 1974;99:425-33.
97. Peters CJ. Arenaviruses. In: Belshe R, editor. Textbook of Human Virology. 2nd ed. St. Louis: Mosby Year Book, Inc; 1991. p. 541-70.
98. Pini N, Resa A, Laime G, et al. Hantavirus infections in children in Argentina. Emerg Infect Dis 1998;4(1):1-3.
99. Ponzinibbio C, Gonzalez PH, Maiztegui JI, Laguens RP. Estudio morfológico de la médula osea humana en Fiebre Hemorrágica Argentina. Medicina (Buenos Aires) 1979;39:441-6.
100. Ravkov EV, Rollin PE, Ksiazek TG, Peters CJ, Nichol ST. Genetic and serologic analysis of Black Creek Canal virus and its association with human disease and *Sigmodon hispidus* infection. Virology 1995;210:482-9.
101. Redford KH, Eisenberg JF. Mammals of the Neotropics. Chicago: The University of Chicago Press; 1992.
102. Rollin PE, Ksiazek TG, Elliot LH, et al. Isolation of Black Creek Canal virus, a new hantavirus from *Sigmodon hispidus* in Florida. J Med Virol 1995;46:35-9.
103. Rowe WP, Pugh WE, Webb PA, Peters CJ. Serological relationship of the Tacaribe complex viruses to Lymphocytic Choriomeningitis Virus. J Virol 1970;5:289-92.
104. Saavedra N, Feuillade M, Levis S, Maiztegui J, Haas E. Antígenos de histocompatibilidad en la Fiebre Hemorrágica Argentina. Medicina (Buenos Aires) 1985;45:342.
105. Sabattini MS, Maiztegui JI. Adelantos en Medicina: Fiebre Hemorrágica Argentina, Medicina (Buenos Aires) 1970;30(1):111-28.
106. Sabattini MS, Gonzalez de Rios LE, Diaz G, Vega VR. Infección natural y experimental de roedores con virus Junin. Medicina (Buenos Aires) 1977;37(3):149-59.

107. Sabattini MS, Contigiani MS. Ecological and biological factors influencing the maintenance of arenaviruses in nature, with special reference to the agent of Argentine Hemorrhagic Fever. In: Pinheiro FD, editor. International Symposium on Tropical Arbovirus and Hemorrhagic Fevers. Rio de Janeiro: Academia Brasileira de Ciencias; 1982. p. 251-2.
108. Salas R, de Manzione N, Tesh RB, et al. Venezuelan Hemorrhagic Fever. Lancet 1991;338:1033-6.
109. Schamajohn C, Hjelle B. Hantaviruses: A global disease problem. Emerg Infect Dis 1997;3(2):95-104.
110. Spiropoulou CF, Morzunov S, Feldman H, Sanchez A, Peters CJ, Nichol ST. Genome structure and variability of a virus causing hantavirus pulmonary syndrome. Virology 1994;200:715-23.
111. Tesh RB, Wilson ML, Salas R, et al. Field studies on the epidemiology of Venezuelan Hemorrhagic Fever: Implication of the cotton rat *Sigmodon alstoni* as the probable rodent reservoir. Am J Trop Med Hyg 1993;49(2):227-35.
112. Vallejos DA, Ambrosio AM, Feuillade MR, Maiztegui JI. Lymphocyte subsets alteration in patients with Argentine Hemorrhagic Fever. J Med Virol 1989;27:160-3.
113. Vitek CR, Breiman RF, Ksiazek TG, et al. Evidence against person-to-person transmission of hantavirus to health care workers. Clin Infect Dis 1996;22:824-6.
114. Vitullo AD, Hodara VL, Merani MS. Effect of persistent infection with Junin virus on growth and reproduction of its natural reservoir, *Calomys musculus*. Am J Trop Med Hyg 1987;37:663-9.
115. Vitullo AD, Merani MS. Vertical transmission of Junin virus in experimentally infected adult *Calomys musculus*. Intervirology 1990;31:339-44.
116. Webb PA, Justines G, Johnson KM. Infection of wild and laboratory animals with Machupo and Latino viruses. Bull World Health Organ 1975;52:493-9.
117. Weissenbacher M, Merani MS, Hodara VL, et al. Hantavirus infection in laboratory and wild rodents in Argentina. Medicina (Buenos Aires) 1990;50:43-6.
118. Weissenbacher MC, Cura E, Segura EL, et al. Serological evidence of human hantavirus infection in Argentina, Bolivia, and Uruguay. Medicina (Buenos Aires) 1996;56:17-22.
119. Wells RM, Estani SS, Yadon ZE, et al. An unusual hantavirus outbreak in southern Argentina: Person-to person transmission? Emerg Infect Dis 1997;3(2):171-4.
120. Wells RM, Young J, Williams RJ, et al. Hantavirus transmission in the United States. Emerg Infect Dis 1997;3:361-5.
121. Williams RJ, Bryan RT, Mills JN, et al. An outbreak of hantavirus pulmonary syndrome in western Paraguay. Am J Trop Med Hyg 1997;57:274-82.
122. Wulff H, Hanger JV, Webb PA. Interrelationships among arenaviruses measured by indirect immunofluorescence. Intervirology 1978;9:344-50.
123. Yangihara R. Hantavirus infection in the United States: Epizootiology and epidemiology. Rev Infect Dis 1990;12:449-57.
124. Zaki SR, Peters CJ. Viral hemorrhagic fevers. In: Connor DH, Chandler FW, Schwartz DA, Manz HJ, Lack EE, editors. The Pathology of Infectious Diseases. Norwalk (Conn):

Appleton and Lange; 1997. p. 347-64.

125. Zaparoli MA, Iversson LB, Rosa MD, et al. Investigation on case-contacts of human disease caused by hantavirus in Juquitiba, State of Sao Paulo, Brazil [abstract]. *Am J Trop Med Hyg* 1995;53:232-3.



# **Borna Disease Infection in Humans**

W. Ian Lipkin, M.D. and Carolyn G. Hatalski, Ph.D.

*University of California, Irvine, U.S.A.*

Borna disease virus (BDV) is a newly classified nonsegmented negative-strand RNA virus with international distribution that infects a broad range of warm-blooded animals ranging from birds to primates. Infection results in movement and behavioral disturbances that are reminiscent of some neuropsychiatric syndromes. BDV has not been clearly linked to any human disease; however, several reports suggest an association between BDV infection and selected neuropsychiatric disorders.

# Introduction

Although Borna disease (BD) was first recognized in the early 1800s as a neurological syndrome with an infectious basis, Borna disease virus (BDV) has only recently been characterized as the causative agent. BDV is the prototype of a newly recognized virus family, *Bornaviridae*, within the nonsegmented negative-strand RNA viruses (order *Mononegavirales*) [50,62]. Several aspects of the molecular biology of BDV are unusual including nuclear localization for replication and transcription [13], overlap of open reading frames and transcription units [14,49], posttranscriptional modification of subgenomic RNAs [17,51], and marked conservation of coding sequence across a wide variety of animal species and tissue culture systems [6,52]. BDV replicates at lower levels than most known viruses [35,43], is not lytic, and persists in the nervous system despite a vigorous immune response [11,54]. BDV is tropic for the limbic circuits, reflecting at least in part, a requirement for phosphorylation by a cellular kinase (PKC $\epsilon$ ) with similar distribution [53]. In the classical syndrome, infected animals present with disorders of movement and behavior [35,57,58]; however, clinical signs may be dramatic, subtle, or inapparent depending on the integrity and intensity of the host immune response to viral gene products and the time of infection relative to brain development.

# Natural Infection and Transmission

Originally described as a disease of horses, BD has also been found in sheep, llamas, ostriches, cats, and cattle [reviewed in 46]. Because an even larger variety of species has been experimentally infected, it is predicted that the host range is likely to include all warm-blooded animals. There are no data concerning infection of species other than warm-blooded hosts.

The geographic distribution of BDV is unknown. Natural infection has been reported only in Central Europe, North America, and parts of Asia (Japan and Israel). This apparent restriction, however, may reflect lack of reliable methods and reagents for diagnosis of infection or failure to consider the possibility of BDV infection. Recent reports of asymptomatic naturally-infected animals do indeed suggest that the virus may be even more widespread than previously appreciated [28,39,40].

Neither the reservoir nor the mode for transmission of natural infection is known. An olfactory route for transmission has been proposed because intranasal infection is efficient and the olfactory bulbs of naturally infected horses show inflammation and edema early in the course of disease [22,37]. Reports of BDV nucleic acid and proteins in peripheral blood mononuclear cells (PBMC) also indicate a potential for hematogeneous transmission [8-11,29,30,39-41,48,55]. Experimental infection of rodents results in virus persistence and is associated with the presence of viral gene products in saliva, urine, and feces [55]. Such secreta/excreta are known to be important in transmission of other pathogenic viruses (e.g., lymphocytic choriomeningitis virus, hantaviruses). Thus the rodent provides the potential for both a natural reservoir and vector; however, because no studies of natural BDV infection have been reported in rodents, the significance of rodents for transmission of BDV to other domesticated animals and humans remains speculative. There are no published data concerning vertical transmission of BDV in natural or experimental hosts.

# Animal Models for BDV Pathogenesis

BD in naturally-infected horses and sheep is characterized by agitated aggressive behavior that progresses over a period of weeks to paralysis and inanition [1]. Efforts to find a convenient rodent model settled on the Lewis rat because the immune-mediated disease in this animal model most closely resembles that seen in naturally-infected horses and sheep. Rats infected as adults have hyperactivity and exaggerated startle responses coincident with the appearance of viral gene products in limbic system neurons and infiltration of mononuclear cells into the brain [15,42]. The inflammation recedes over a period of several weeks but virus persists and animals show stereotyped motor behaviors, dyskinesias, and dystonias associated with distinct changes in the CNS dopamine system [55,56] as well as decreased activity and cachexia [42]. In contrast, rats infected as neonates do not mount a cellular immune response to the virus and have a different disease characterized by stunted growth, hyperactivity, subtle learning disturbances, and altered taste preferences [16,20].

Behavioral disturbances have been reported in experimentally infected primates: tree shrews and rhesus monkeys. Infected tree shrews have altered social and sexual behaviors, manifested as abnormal dominance relationships and failure to mate [59]. Infected rhesus monkeys are initially hyperactive and subsequently become apathetic and hypokinetic [60].



# BDV and Neuropsychiatric Disease

## Serology

Recognition of BDV's broad host and geographic range led to the proposal that it might cause human neuropsychiatric disease. Because the behavioral disturbances in animals were considered to be reminiscent of affective disorders, particularly bipolar depression, initial studies were targeted toward investigation of these disorders. The earliest work to suggest a link between BDV and human mental illness came from a serologic survey in 1985 of 285 subjects with affective disorders in the United States, 694 subjects with affective disorders in Germany, and 105 normal controls [45]. Using an indirect immunofluorescence assay (IFA) to detect the presence of antibodies reactive with a BDV-infected cell line, sera from 12 patients from the United States (4.3%) and four patients from Germany (less than 1%) were immunoreactive. No control sera were immunoreactive. Sera from many of these subjects were subsequently analyzed using a Western immunoblot assay based on BDV nucleoprotein (N) and phosphoprotein (P) purified by affinity chromatography from infected rabbit kidney cells [21]. In this study of 138 affective disorder patients and 117 healthy controls, antibodies to N were found in 53 patients (38%) *versus* 19 controls (16%); antibodies to P were found in 16 patients (12%) *versus* 5 controls (4%); antibodies to both proteins were found in 9 patients (6.5%) *versus* 1 control (less than 1%).

With the objective of establishing a correlation between immunoreactivity to BDV and the duration and severity of psychiatric disease, Bode *et al.* performed IFA on multiple sera samples taken at a number of timepoints from 71 patients with a variety of diagnoses including minor or major depression, paranoid psychosis, schizophrenia, anxiety disorder, and personality disorder [7]. Overall, the prevalence of immunoreactivity to BDV was greater than 20%, a marked increase from the 2 to 4% found in the earlier study by assay of each subject at one timepoint. Thirty-seven percent of patients diagnosed with major depression, 25% of patients with paranoid psychosis, but only 6% or less of patients with reactive depression and other neurotic conditions were seropositive by day 17 of illness. Since BDV gene products have been identified in PBMC of infected rats [55], PBMC from patients with various neuropsychiatric diseases were examined for the presence of viral antigens by fluorescence activated cell sorting analysis [8]. Of the 70 subjects with neuropsychiatric disease assayed, more than 40% were found to be antigen carriers, twice the number predicted by the previous serologic survey.

Some investigators have been impressed by similarities between particular animal models of BDV infection and schizophrenia. Infection of neonatal rats results in subtle signs of disease including learning deficiencies and hyperactivity with CNS abnormalities such as cerebellar disorganization and loss of dentate gyrus granule cells [2,3,16,20]. These findings are consistent with a long-standing hypothesis that schizophrenia reflects an early brain insult (e.g., infection) resulting in abnormal brain development [68] and led Waltrip *et al.* to investigate whether BDV infection might be implicated in the pathogenesis of schizophrenia [66]. A Western immunoblot assay based on BDV N, P, and gp18 proteins purified from infected human neuroblastoma cells was used to examine sera from 90

schizophrenic patients and 20 normal controls. Antibodies to one BDV protein (N, P, or gp18) were detected in 29 patients (32%) *versus* 4 controls (20%). Antibodies to two or more BDV proteins were detected in 13 patients (14.4%) *versus* 0 controls. Antibodies to gp18 protein were found in 12 patients (13.3%) *versus* 0 controls. Immunoreactivity to two or more BDV proteins or gp18 protein was significantly associated with abnormal brain morphology in magnetic resonance image analysis (MRI) and the clinical diagnosis of deficit syndrome (a schizophrenia subgroup characterized by social withdrawal, neurological dysfunction and neuroanatomic abnormalities). Similar findings were reported by Bechter *et al.*, indicating an association between the presence of antibodies reactive with BDV proteins and MRI evidence of cerebral atrophy in schizophrenic patients [5].

### *Molecular Epidemiology*

Interest in a potential role for BDV as a human pathogen and in BDV-infected animals as models for human neuropsychiatric diseases led to an intensive effort to identify the infectious agent. Due to low viral productivity and tight association of BDV with plasma membranes, classic methods for virus isolation were unsuccessful. By adopting a purely molecular subtractive cloning approach, however, BDV nucleic acids were independently cloned by two groups [33,65]. The viral genome was subsequently cloned from viral particles [14] and nuclear extracts of infected cells [18]. With the advent of viral sequence information, new diagnostic reagents for BDV infection were introduced, including recombinant proteins for serology as well as oligonucleotide primers and probes for molecular epidemiology.

The earliest experiments in BDV molecular epidemiology were directed toward determining whether conserved sequences could be identified across several host species. Reverse transcription polymerase chain reaction (RT-PCR) was used to amplify and clone coding and noncoding sequences from different virus strains divergent by over 50 years growth in nature as well as extensive experimental passage through rabbit and rat brains and cell lines from a variety of species. Because of inaccuracies in viral RNA-dependent RNA polymerases, most single-stranded RNA viruses have sequence divergence of 10<sup>3</sup>-10<sup>4</sup> per site per round of replication [25,26,38]. Sequence analysis of BDV isolates revealed a much lower rate of divergence. For N and P sequences, maximum variability was 4.1% at the nucleotide level and 1.5% at the predicted amino acid level [52]. Similar sequence conservation was later found for sequences from naturally infected donkeys, sheep, and cats [6; H. Ludwig, personal communication]. The extent to which sequence conservation in BDV represents enhanced polymerase fidelity, or more likely selective environmental pressures, is unknown.

Extending molecular analysis to human materials has proven to be both complex and controversial. There is a general consensus that if BDV does infect humans with neuropsychiatric diseases, viral nucleic acids are present at lower concentrations in the human brain and PBMC than in previously studied naturally or experimentally infected hosts. Investigators who report isolation of BDV nucleic acid from human PBMC have utilized nested RT-PCR, a method that while sensitive is also prone to contamination artifacts. Two

groups each in Germany and Japan have detected viral nucleic acid in PBMC of patients with assorted neuropsychiatric diseases: Bode and colleagues found BDV nucleic acids in 4 of 6 patients (66.7%) [10]; Sauder and colleagues found BDV sequences in 13 of 26 neuropsychiatric patients (50%) (seven subjects with schizophrenia, one subject with affective disorder, and five subjects with other psychiatric disorders) [48]; Kishi and coworkers found BDV nucleic acids in PBMC of 22 out of 60 neuropsychiatric patients (37%) [29] and 8 out of 172 blood donor controls (4.7%) [30]; Igata-Yi *et al.* detected BDV nucleic acids in 6 of 55 neuropsychiatric patients (10.9%) (five subjects with schizophrenia, one subject with depression) *versus* 0 of 36 blood donor controls [27]; and Nakaya *et al.* reported BDV nucleic acid in 3 of 25 chronic fatigue syndrome patients (12%) [41].

Evidence of human infection has also been described in the brain. de la Torre and colleagues reported BDV nucleic acids and immunoreactivity in the hippocampus of 4 of 5 North American patients with post-mortem diagnosis of hippocampal sclerosis [63]. Examining material from North American and European brain banks, Salvatore *et al.* reported BDV nucleic acids in the brains of 9 of 17 patients with schizophrenia and 2 of 5 patients with bipolar disorder, but none in 64 subjects with other neuropsychiatric disorders or normal controls [47]. In Japan, Haga and coworkers found BDV nucleic acids in the brains of 3 of 9 patients with schizophrenia, 1 of 6 patients with Parkinson's disease, and 2 of 31 normal controls [23].

Analyses of BDV isolates from human patients have yielded differing estimates of sequence conservation. Bode and colleagues [10] and Sauder and coworkers [48] have reported extensive conservation of the N and P open reading frames that is consistent with previous findings in field and tissue culture isolates [52]. There is a recent report of isolation of infectious BDV following cocultivation of PBMC from neuropsychiatric patients with a human oligodendroglial cell line [11]. Sequences of these isolates were highly conserved with previously identified sequences [64]. Other groups have described greater sequence divergence [31,41]. It has been suggested, however, that differences in levels of sequence conservation may reflect variations in methods for RT-PCR amplification rather than true strain differences [48].

Other studies have been reported where RT-PCR did not yield evidence of BDV nucleic acid in subjects with neuropsychiatric diseases. Sierra-Honigmann and colleagues found no BDV nucleic acid by RT-PCR analysis of brain tissue, cerebrospinal fluid, or PBMC from subjects with schizophrenia [56]. Similarly, Richt and colleagues found no evidence of BDV nucleic acid in RT-PCR studies of PBMC from 26 subjects with schizophrenia and 9 subjects with affective disorders [44]. We recently completed RT-PCR analysis of PBMC from 70 Swedish and 50 U.S. chronic fatigue syndrome patients and found no evidence for infection [B. Evengard, W.I. Lipkin, and S. Lee, unpublished].

### *Special Considerations for BDV Diagnostics*

There are no generally accepted standards for diagnosis of human BDV infection. A wide variety of assays (indirect immunofluorescence, western immunoblot, radioimmunoprecipitation, and ELISA) and antigen preparations (infected cells, infected cell

extracts, and recombinant proteins produced in prokaryotic or baculovirus systems) have been employed for BDV serology. There are only limited published data concerning interassay comparability for serology within individual laboratories and none between different laboratories. Thus, it remains to be determined whether discrepancies between investigators reflect differences in clinical populations, assay sensitivity, or other factors.

Similarly, there is only limited agreement concerning methods for molecular diagnosis of BDV infection. Most investigators employ RT-PCR, however, whereas some use a method sensitive to 100-300 copies of RNA template (nested RT-PCR, 80-100 cycles), others use less sensitive methods (no nesting, 30 cycles). Only investigators using the more sensitive method have reported the presence of BDV gene products in human materials (PBMC, brain).

The method of RT-PCR, particularly nested RT-PCR, is prone to artifacts due to inadvertent introduction of template from laboratory isolates or cross contamination of samples. The observation that putative human isolates detected by nested RT-PCR are similar in sequence to known animal and tissue culture isolates has been used as evidence to argue that they represent low level contaminants. However, the finding of sequence conservation is consistent with previous analyses of well-characterized isolates disparate by host species and geography [6,52] and cannot be used to discount the validity of positive nested RT-PCR results.

### *Antiviral Therapy for Presumed Human BDV Infection*

Bode and coworkers initiated a trial of amantadine in affective disorder patients with evidence of BDV infection by RT-PCR analysis of PBMC [12] and reported clinical improvement coterminous with the disappearance of circulating nucleic acid positive cells. These results prompted establishment of a center for antiviral treatment of affective disorders due to BDV and the attention of popular media in Europe and North America [32,36]. Two groups subsequently reported that amantadine has no effect on replication *in vitro* or *in vivo* (rodent models) of either strain V or He/80 of BDV [19,24]. Bode *et al.* maintain that amantadine is effective in treatment of human strains of BDV but not the strains employed by other groups (strain V or He/80). Whether the response to amantadine in patients with affective disorders reflects antiviral properties or enhanced monoaminergic transmission (a known effect of amantadine) remains to be determined.

# Future Directions

The broad potential host range for BDV suggests that humans are targets for infection. Although there is consensus amongst workers in the field that BDV could infect humans and is likely to do so, a number of questions with respect to human infection remain unanswered. The sources and routes for potential human infection are not clear. Naturally-infected horses, sheep, cattle, cats, and birds could serve as reservoirs for the virus; however, no detailed epidemiology has been done in animal populations and there are no studies that demonstrate transmission from domestic animals to humans. As discussed earlier, rodents with persistent BDV infection and minimal overt signs of disease could serve as vectors for transmission. Domestic animals and livestock might also serve as vectors for transmission to humans. Serum antibodies reactive with BDV have been detected in asymptomatic farmworkers exposed to ostriches with a BD-like syndrome [67]. Immunoreactivity to BDV and neurological disturbances have been reported in a farmworker exposed to seropositive, asymptomatic horses and sheep [4]. Finally, although no human cases of disease have been linked to feline infection, there is evidence for BDV infection in house cats in Europe [34] and Japan [40].

Viral gene products are readily detected in CNS of natural and experimental hosts without recourse to methods as sensitive as nested RT-PCR. The observation that sensitive methods must be employed to detect BDV nucleic acid in humans indicates that the virus is present only at low levels. Thus, if BDV can be implicated as a factor in human neuropsychiatric disease, mechanisms for pathogenesis may be different than those in other natural and experimental hosts. Indeed, in the event that an association can be established between BDV infection and a neuropsychiatric disease, it will not necessarily imply that BDV causes that disease. It is equally plausible that the disorder results in enhanced BDV gene expression due to treatment with psychotropic drugs or increased exposure to infectious agents including BDV, particularly in subgroups of patients with lower socioeconomic status [47].

Although many studies have reported a higher prevalence of markers for BDV infection in neuropsychiatric patients than in controls, no single neuropsychiatric disease has been correlated with BDV infection. To date, efforts to link BDV with neuropsychiatric disease have not utilized accepted standards for epidemiology.

In an effort to rigorously address the issues of BDV epidemiology and pathogenesis, multicenter groups in Europe and the United States are collaborating to pursue coordinated collection and blinded analysis of human clinical materials using standardized methods and reagents. The objectives of these multicenter projects will be to determine the prevalence of serum antibodies to BDV in patients and controls, the extent to which the various assays for antibodies are in accord, the prevalence of BDV nucleic acids in brains and PBMC of patients and controls, and whether the presence of antibodies to BDV or viral nucleic acids can be correlated with a particular neuropsychiatric disease. These surveys will be essential for defining the role of BDV as a human pathogen.

# Acknowledgments

The Laboratory for Neurovirology at the University of California, Irvine is supported by grants from the National Institutes of Health and the Lucille P. Markey Trust.

# References

1. Abildgaard PC. Pferde-und Vieharzt in einem kleinen Auszuge; oder, Handbuch von den gewöhnlichsten Krankheiten der Pferde, des Hornviehes, der Schafe und Schweine, sammt der bequemsten und wohlfeilesten Art sie zu heilen. Zum Gebrauch des Landmanns. Wien: Johann Thomas Edlen von Trattnern; 1785.
2. Bautista JR, Schwartz GJ, de la Torre JC, Moran TH, Carbone KM. Early and persistent abnormalities in rats with neonatally acquired Borna disease virus infection. *Brain Res Bull* 1994;34:31-40.
3. Bautista JR, Rubin SA, Moran TH, Schwartz GJ, Carbone KM. Developmental injury to the cerebellum following perinatal Borna disease virus infection. *Dev Brain Res* 1995;90:45-53.
4. Bechter K, Schüttler R, Herzog S. Case of neurological and behavioral abnormalities: due to Borna disease virus encephalitis? *Psychiatry Res* 1992;42:193-6.
5. Bechter K, Bauer M, Estler HC, Herzog S, Schuttler R, Rott R. Expanded nuclear magnetic resonance studies in Borna disease virus seropositive patients and control probands. *Nervenarzt* 1994;65:169-74.
6. Binz T, Lebelt J, Niemann H, Hagenau K. Sequence analyses of the p24 gene of Borna disease virus in naturally infected horse, donkey and sheep. *Virus Res* 1994;34:281-9.
7. Bode L, Ferszt R, Czech G. Borna disease virus infection and affective disorders in man. *Arch Virol* 1993; 7 Suppl:159-67.
8. Bode L, Steinbach F, Ludwig H. A novel marker for Borna disease virus infection. *Lancet* 1994;343:297-8.
9. Bode L. Human infections with Borna disease virus and potential pathologic implications. *Curr Top Microbiol Immunol* 1995;190:103-30.
10. Bode L, Zimmermann W, Ferszt R, Steinbach F, Ludwig H. Borna disease virus genome transcribed and expressed in psychiatric patients. *Nature Med* 1995;1:232-6.
11. Bode L, Dürrwald R, Rantam FA, Ferszt R, Ludwig H. First isolates of infectious human Borna disease virus from patients with mood disorders. *Mol Psychiatry* 1996;1:200-12.
12. Bode L, Dietrich DE, Stoyloff R, Emrich HM, Ludwig H. Amantadine and human Borna disease virus in vitro and in vivo in an infected patient with bipolar depression [letter]. *Lancet* 1997;349:178-9.
13. Briese T, de la Torre JC, Lewis A, Ludwig H, Lipkin WI. Borna disease virus, a negative-strand RNA virus, transcribes in the nucleus of infected cells. *Proc Natl Acad Sci USA* 1992;89:11486-9.
14. Briese T, Schneemann A, Lewis AJ, et al. Genomic organization of Borna disease virus. *Proc Natl Acad Sci USA* 1994;91:4362-6.
15. Carbone K, Duchala C, Griffin J, Kincaid A, Narayan O. Pathogenesis of Borna disease in rats: evidence that intra-axonal spread is the major route for virus dissemination and the determination for disease incubation. *J Virol* 1987;61:3431-40.
16. Carbone K, Park S, Rubin S, Waltrip R, Vogelsang G. Borna disease: association with a maturation defect in the cellular immune response. *J Virol* 1991;65:6154-64.

17. Cubitt B, Oldstone C, Valcarel V, de la Torre JC. RNA splicing contributes to the generation of mature mRNAs of Borna disease virus, a non-segmented negative strand RNA virus. *Virus Res* 1994;34:69-79.
18. Cubitt B, Oldstone C, de la Torre JC. Sequence and genome organization of Borna disease virus. *J Virol* 1994;68:1382-96.
19. Cubitt B, de la Torre JC. Amantadine does not have antiviral activity against Borna disease virus. *Arch Virol* 1997;142:2035-42.
20. Dittrich W, Bode L, Ludwig H, Kao M, Schneider K. Learning deficiencies in Borna disease virus-infected but clinically healthy rats. *Biol Psychiatry* 1989;26:818-28.
21. Fu ZF, Amsterdam JD, Kao M, Shankar V, Koprowski H, Dietzschold B. Detection of Borna disease virus-reactive antibodies from patients with affective disorders by western immunoblot technique. *J Affect Disorders* 1993;27:61-8.
22. Gosztanyi G, Ludwig H. Borna disease-neuropathology and pathogenesis. *Curr Top Microbiol Immunol* 1995;190:39-73.
23. Haga S, Motoi Y, Ikeda K. Borna disease virus and neuropsychiatric disorders. The Japan Bornavirus Study Group. *Lancet* 1997;350:592-3.
24. Hallensleben W, Zocher M, Staeheli P. Borna disease virus is not sensitive to amantadine. *Arch Virol* 1997;142:2043-8.
25. Holland J, Spindler K, Horodyski F, Grabau E, Nichol S, VandePol S. Rapid evolution of RNA genomes. *Science* 1982;215:1577-85.
26. Holland JJ, de la Torre JC, Steinhauer DA. RNA virus populations as quasispecies. *Curr Top Microbiol Immunol* 1992;176:1-20.
27. Igata-Yi R, Kazunari Y, Yoshiki K, et al. Borna disease virus and consumption of raw horse meat. *Nature Med* 1996;2:948-9.
28. Kao M, Hamir AN, Rupprecht CE, et al. Detection of antibodies against Borna disease virus in sera and cerebrospinal fluid of horses in the USA. *Vet Rec* 1993;132:241-4.
29. Kishi M, Nakaya T, Nakamura Y, et al. Demonstration of human Borna disease virus RNA in human peripheral blood mononuclear cells. *FEBS Letters* 1995;364:293-7.
30. Kishi M, Nakaya T, Nakamura Y, et al. Prevalence of Borna disease virus RNA in peripheral blood mononuclear cells from blood donors. *Med Microbiol Immunol* 1995;184:135-8.
31. Kishi M, Arimura Y, Ikuta K, Shoya Y, Lai PK, Kakinuma M. Sequence variability of Borna disease virus open reading frame II found in human peripheral blood mononuclear cells. *J Virol* 1996;70:635-40.
32. Kunzig, R. It kills horses, doesn't it? *Discover* 1997;97-105.
33. Lipkin WI, Travis G, Carbone K, Wilson M. Isolation and characterization of Borna disease agent cDNA clones. *Proc Natl Acad Sci USA* 1990;87:4184-8.
34. Lundgren A-L, Czech G, Bode L, Ludwig H. Natural Borna disease in domestic animals other than horses and sheep. *J Vet Med* 1993;40:298-303.
35. Ludwig H, Bode L, Gosztanyi G. Borna disease: a persistent disease of the central nervous system. *Prog Med Virol* 1988;35:107-51
36. Mestel R. Mind-altering bugs. *New Scientist* 1997;42-5.
37. Morales JA, Herzog S, Kompter C, Frese K, Rott R. Axonal transport of Borna



- disease virus along olfactory pathways in spontaneously and experimentally infected rats. *Med Microbiol Immunol* 1988;177:51-68.
38. Morse SS. *The evolutionary biology of viruses*. New York: Raven; 1994.
  39. Nakamura Y, Kishi M, Nakaya T, et al. Demonstration of Borna disease virus RNA in peripheral blood mononuclear cells from healthy horses in Japan. *Vaccine* 1995;13(12):1076-9.
  40. Nakamura Y, Asahi S, Nakaya T, et al. Demonstration of borna disease virus RNA in peripheral blood mononuclear cells derived from domestic cats in Japan. *J Clin Microbiol* 1996;34(1):188-91.
  41. Nakaya T, Takahashi H, Nakamura Y, et al. Demonstration of Borna disease virus RNA in peripheral blood mononuclear cells derived from Japanese patients with chronic fatigue syndrome. *FEBS Letters* 1996;378:145-9.
  42. Narayan O, Herzog S, Frese K, Scheefers H, Rott R. Behavioral disease in rats caused by immunopathological responses to persistent Borna virus in the brain. *Science* 1983;220:1401-3.
  43. Richt JA, VandeWoude S, Zink MC, et al. Infection with Borna disease virus: molecular and immunobiological characterization of the agent. *Clin Inf Dis* 1992;14:1240-50.
  44. Richt JA, Alexander RC, Herzog S, et al. Failure to detect Borna disease virus infection in peripheral blood leukocytes from humans with psychiatric disorders. *J Neurovirol* 1997;3:174-8.
  45. Rott R, Herzog S, Fleischer B, et al. Detection of serum antibodies to Borna disease virus in patients with psychiatric disorders. *Science* 1985;228:755-6.
  46. Rott R, Becht H. Natural and experimental Borna disease in animals. *Curr Top Microbiol Immunol* 1995;190:17-30.
  47. Salvatore M, Morzunov S, Schwemmle M, Lipkin WI, Bornavirus Study Group. Borna disease virus in brains of North American and European people with schizophrenia and bipolar disorder. *Lancet* 1997;349:1813-14.
  48. Sauder C, Muller A, Cubitt B, et al. Detection of Borna disease virus (BDV) antibodies and BDV RNA in psychiatric patients: evidence for high sequence conservation of human blood-derived BDV RNA. *J Virol* 1996;70:7713-24.
  49. Schneemann A, Schneider PA, Kim S, Lipkin WI. Identification of signal sequences that control transcription of Borna disease virus, a nonsegmented negative-strand RNA virus. *J Virol* 1994;68:6514-22.
  50. Schneemann A, Schneider PA, Lamb RA, Lipkin WI. The remarkable coding strategy of Borna disease virus: a new member of the nonsegmented negative strand RNA viruses. *Virology* 1995;210:1-8.
  51. Schneider PA, Schneemann A, Lipkin WI. RNA splicing in Borna disease virus, a nonsegmented, negative-strand RNA virus. *J Virol* 1994;68:5007-12.
  52. Schneider PA, Briese T, Zimmermann W, Ludwig H, Lipkin WI. Sequence conservation in field and experimental isolates of Borna disease virus. *J Virol* 1994;68:63-8.
  53. Schwemmle M, De B, Shi L, Banerjee A, Lipkin WI. Borna disease virus P-protein is phosphorylated by protein kinase Ce and casein kinase II. *J Biol Chem* 1997;272:21818-23.

54. Schwemmler M, Hatalski CG, Even C, Lewis AJ, Lipkin WI. Bornaviruses. In: Ahmed R, Chen I, editors. *Persistent Viral Infections*. New York: John Wiley & Sons; In Press.
55. Sierra-Honigmann AM, Rubin SA, Estafanous MG, Yolken RH, Carbone KM. Borna disease virus in peripheral blood mononuclear and bone marrow cells of neonatally and chronically infected rats. *J Neuroimmunol* 1993;45:31-6.
56. Sierra-Honigmann AM, Carbone KM, Yolken RH. Polymerase chain reaction (PCR) search for viral nucleic acid sequences in schizophrenia. *Brit J Psychiatry* 1995;166:55-60.
57. Solbrig MV, Fallon JH, Lipkin WI. Behavioral disturbances and pharmacology of Borna disease virus. *Curr Top Microbiol Immunol* 1995;190:93-102.
58. Solbrig MV, Koob GF, Joyce JN, Lipkin WI. A neural substrate of hyperactivity in Borna disease: changes in dopamine receptors. *Virology* 1996;222:332-8.
59. Sprankel H, Rícharz K, Ludwig H, Rott R. Behavior alterations in tree shrews induced by Borna disease virus. *Med Microbiol Immunol* 1978;165:1-18.
60. Stitz L, Krey H, Ludwig H. Borna disease in rhesus monkeys as a model for uveo-cerebral symptoms. *J Med Virol* 1980;6:333-40.
61. Stitz L, Dietzschold B, Carbone KM. Immunopathogenesis of Borna disease. *Curr Top Microbiol Immunol* 1995;190:75-92.
62. de la Torre JC. Molecular biology of Borna disease virus: prototype of a new group of animal viruses. *J Virol* 1994;68:7669-75.
63. de la Torre JC, Gonzalez-Dunia D, Cubitt B, et al. Detection of Borna disease virus antigen and RNA in human autopsy brain samples from neuropsychiatric patients. *Virology* 1996;223:272-82.
64. de la Torre JC, Bode L, Durrwald R, Cubitt B, Ludwig H. Sequence characterization of human Borna disease virus. *Virus Res* 1996;44:33-44.
65. VandeWoude S, Richt J, Zink M, Rott R, Narayan O, Clements J. A Borna virus cDNA encoding a protein recognized by antibodies in humans with behavioral diseases. *Science* 1990;250:1276-81.
66. Waltrip II RW, Buchanan RW, Summerfelt A, et al. Borna disease virus and schizophrenia. *Psychiatry Res* 1995;56:33-44.
67. Weisman Y, Hummer D, Malkinson M, et al. Borna disease virus antibodies among workers exposed to infected ostriches. *Lancet* 1994;344:1232-3.
68. Yolken RH, Torrey EF. Viruses, schizophrenia, and bipolar disorder. *Clin Microbiol Rev* 1995;8:131-45.



# Dengue Hemorrhagic Fever

Suchitra Nimmannitya, M.D.

*Children's Hospital, Bangkok, Thailand*

# Introduction

Dengue hemorrhagic fever (DHF), the most severe form of dengue illness, is currently the most important mosquito-borne viral disease, both in terms of morbidity and mortality. Unlike dengue fever (DF), the disease known for over 200 years as a benign nonfatal disease, DHF has the potential to develop into dengue shock syndrome (DSS) which is associated with high mortality. The World Health Organization (WHO) has estimated that 100 million dengue infections occur annually, with approximately 350,000 to 500,000 of these DHF/DSS. With case-fatality rates of 1 to 5%, several thousand deaths occur each year, mostly in children [12].

DHF has emerged to become one of the major public health problems worldwide. It was first reported in Southeast Asia in the mid-1950s, and spread rapidly throughout tropical Asia where both humans and *Aedes aegypti* mosquitoes are densely populated. There was a resurgence of dengue in the Americas in the 1970s. The first outbreak of DHF in Cuba occurred in 1981. This initiated an evolution of epidemic DHF patterns in the Americas that was almost identical to that which occurred in Southeast Asia in the 1960s [8]. A global pandemic has intensified during the past 17 years with expanding geographic distribution, increased epidemic frequency, and the emergence of DHF in new areas. For over four decades clinicians, epidemiologists, virologists, and research scientists worldwide have had the opportunity to make observations and study various aspects of this disease. A great deal of information has been accumulated, resulting in better patient care. There are, however, a number of unresolved issues related to DHF, in particular its pathogenic mechanism.

The various aspects of DHF which have been studied over the past four decades are summarized in this report.

# Clinical Features

Dengue infections caused by any of the four dengue virus serotypes (DEN 1-4) may be asymptomatic or may lead to undifferentiated fever (UF) or viral syndrome, dengue fever, or DHF. Dengue hemorrhagic fever is distinguished by its potential to develop into fatal dengue shock syndrome resulting from plasma leakage [39].

## *Dengue Fever*

The clinical features of DF are age-dependent. Infants and children infected with dengue virus for the first time (i.e., primary dengue infection) usually develop a simple febrile illness or UF. Dengue fever is most common in adults and older children and may either be benign or present as the classic incapacitating disease with severe muscle, joint, and bone pain (break-bone fever). Erythema/maculopapular skin rashes, occasionally with petechiae, are common, as are gastrointestinal symptoms. In rare occasions, unusual hemorrhaging, mostly from gastrointestinal-complicated DF, may result in death. Leukopenia is common and moderate thrombocytopenia is occasionally observed. The clinical presentations of DF vary from location to location and from epidemic to epidemic. It is almost impossible, therefore, to make a clinical diagnosis of DF, particularly in isolated cases. In tropical areas where dengue is endemic, classic DF is infrequently found among indigenous adults [39].

## *Dengue Hemorrhagic Fever*

Unlike DF, DHF occurs mainly in children and its clinical features are rather distinctive. The major pathophysiologic hallmarks that determine disease severity and distinguish DHF from DF and other viral hemorrhagic fevers (VHF) are plasma leakage due to increased vascular permeability and abnormal hemostasis [25]. Hypovolemic shock occurs as a consequence of, and subsequent to, critical plasma volume loss selectively into serous spaces (i.e., pleural and peritoneal cavities). Abnormal hemostasis, including increased capillary fragility (positive tourniquet test and tendency to bruise), thrombocytopenia, impaired platelet function, and in the most severe form, disseminated intravascular coagulation, contribute to varying degrees of hemorrhagic manifestations [32,39].

DHF is typically characterized by four major clinical manifestations presented below in order of their appearance and frequency [24,25,39]:

- High continuous fever for 2 to 7 days in most cases;
- Hemorrhagic diathesis: most frequently presenting as skin petechiae (including a positive tourniquet test);
- Hepatomegaly; and
- Circulatory disturbances (presenting as shock in severe cases).

Thrombocytopenia and hemoconcentration (rising hematocrit of 20% or more) representing the pathophysiologic hallmarks of abnormal hemostasis and plasma leakage, respectively, are constant findings.

The course of DHF is stereotypic and thus it is possible to make an early and accurate

clinical diagnosis based on major manifestations. Following the 5- to 8-day incubation period, the illness typically begins abruptly with high fever accompanied by facial flushing, skin erythema, headache, and other symptoms similar to those of DF. The positive tourniquet test and the presence of skin petechiae in the early febrile phase are suggestive of dengue illness. A finding of liver enlargement as disease progresses provides more support for the clinical diagnosis of DHF. The diagnosis becomes certain when the platelet count drops shortly before, or simultaneously with, a rise in hematocrit. The time course relationship between the fall in platelet count and the rapid rise in hematocrit signaling rapid leakage of plasma, appears to be unique to DHF [25]. These changes are correlated with disease severity. The time at which the platelet count drops and hematocrit rises usually occurs before the fever has subsided and the onset of shock. This is of important diagnostic and prognostic value as it indicates the critical time at which therapeutic intervention should be started to ameliorate disease severity by preventing or decreasing the severity of shock [25].

In severe cases, usually accompanied by a sudden drop in temperature, shock ensues and progresses rapidly to profound shock and death if proper treatment is not given. The period of shock is short but life-threatening; the patient who receives proper management has a rapid and uneventful recovery. Severe hemorrhaging, mostly gastrointestinal and presenting as hematemesis and/or melena, may occur in cases with prolonged shock and confers a poor prognosis with a high mortality rate.

In most cases, early and effective replacement of lost plasma with a glucose electrolyte solution, plasma, or plasma expander results in a favorable outcome. Blood transfusion is indicated in patients with severe bleeding. With early diagnosis and proper treatment of shock, the case-fatality rate of DHF has been markedly reduced. In Thailand, the case-fatality rate has now been lowered from 12.5% to below 1%.

### ***Unusual Presentations of DHF***

There has been increasing reports of DHF cases with hepatic failure and encephalopathy. Although the proportion of these cases are considerably small, they have contributed to the high mortality rate and problems in disease management [15,26]. Cases of encephalitis with confirmed dengue infection have recently been reported [7].

### ***Pathophysiology and Pathogenesis of Shock***

The most prominent feature of DHF is plasma leakage which appears to be selective into the pleural and abdominal cavities. Pericardial effusion, if there is any, is rather minimal. Chest radiographs demonstrate pleural effusion which correlates with disease severity [25]. Other evidence of plasma leakage include a rising hematocrit/hemoconcentration and hypoprotein/hypoalbuminemia. Although the pathogenesis of shock is not well understood, clinical observations and laboratory studies suggest that DSS is hypovolemic due to plasma loss accompanied by an increase in peripheral resistance [25,27].

The increase in vascular permeability leading to plasma leakage is most likely a functional change due to short-lived pharmacologic mediator(s), products of immune

mechanism, rather than structural destruction of endothelial cells. Evidence for this conclusion includes:

- Rapid onset of plasma leakage with sudden elevations in hematocrit;
- Short duration of leakage/shock for 24 to 48 hours;
- Rapid recovery with proper treatment (24 to 48 hours) with uneventful convalescence;
- No sequelae;
- No inflammatory vascular changes found at autopsy [1]; and
- No severe pathologic changes in major organs other than serous effusion and hemorrhage [1].



# Association of DSS with Secondary Dengue Infection

Much research has been done to search for vascular permeability mediators. Investigators of bradykinins [5], histamine [36], and endotoxin [37] have not shown any convincing evidence to support their role as the candidate mediator. The importance of complement activation as a central role in the pathogenesis of DHF has been demonstrated and the role of C3a and C5a anaphylatoxins as potential mediators has been suggested [39]. It has been demonstrated recently that C3a and C5a are elevated, and that their levels as well as the duration of their change correlate with occurrence of shock and with disease severity [23]. Researchers are currently exploring the role of cytokines and chemical mediators. These cytokines include tumor necrosis factor  $\alpha$  (TNF $\alpha$ ), interleukin-1 (IL-1), IL-2, and IL-6. Chemical mediators including platelet activating factor (PAF), histamine, and complement activation products C3a and C5a, have also been explored. Among them, TNF $\alpha$  has received much attention as it is known to be responsible for endotoxic shock. It is noteworthy that selective leakage of plasma into pleural and abdominal cavities is quite unique to DHF [25]. While massive pleural effusion/ascites are constant findings in DSS, they are not observed in endotoxic shock or other viral hemorrhagic fevers. IL-2, a lymphokine mainly produced by T cells, has been shown to cause plasma leakage syndrome in cancer patients who received high dose IL-2 [28]. There was no pleural effusion observed in these patients with IL-2 toxicity [28].

Many studies have provided encouraging results of these cytokines and chemical mediators, but they are still far from being conclusive. Further studies in search of mediators responsible for massive plasma leakage are necessary and are of top priority.

# The Liver and Liver Function

Although liver enlargement is found in the majority of cases, changes in liver function tests primarily consist of mild elevations in AST (aspartate aminotransferase) which is found in DHF but not in DF [17]. In unusual cases with hepatic impairment, however, marked increases of both AST and ALT (alanine aminotransferase) are observed. In these cases, liver failure results in a coagulation defect, severe bleeding, and encephalopathy [26].

# Epidemiology

It is believed that activities related to World War II contributed to the emergence of DHF in Southeast Asia in 1950s. Ecologic disturbance and demographic changes resulted in the dramatic increase in the *A. aegypti* mosquito population and dengue transmission. In addition to movement of indigenous populations, the movement of foreign soldiers and expatriates, most of whom were susceptible to dengue virus infection, aided in the spread of dengue virus [8].

The emergence of DHF in the Americas began with reinfestation of the *A. aegypti* mosquito population and introduction of new dengue serotypes or new strains from Southeast Asia. It is believed that a new strain of DEN2 which was introduced to Cuba from Southeast Asia, probably from Vietnam, was responsible for the outbreak of DHF in Cuba in 1981 [8,18].

During the past two decades there has been increasing activity of dengue that resulted in the emergence of DHF in new tropic and subtropic regions worldwide. It is of special interest that, to date, epidemic DHF has not been reported in Africa despite the increase in DF outbreaks and the presence of all four dengue serotypes [8].

The reasons for global emergence of dengue and DHF are rather complex and not well understood. Some factors, however, have been identified and include [8]:

- Increased human population growth in general, and urban population in particular, which helps maintain the man-virus-mosquito chain of transmission;
- Unplanned urbanization provides more mosquito breeding sites;
- Improved transportation and increased airplane travel facilitate distant spread of infection through viremic persons; and
- The failure of programs to control mosquito populations.

## Dengue Viruses

There are four distinct but closely related serotypes of dengue viruses (DEN 1-4). DEN3 and DEN4 are new members of the dengue complex isolated from DHF patients during the outbreak of DHF in the Philippines and Thailand in 1956 and 1958 [14]. The dengue viruses possess antigens that cross-react with yellow fever, Japanese encephalitis, and West Nile viruses. There is evidence from field and laboratory studies suggesting that there are distinct strain differences between dengue viruses [8]. Recent developments in molecular virology have provided further proof for strain variation [28].

Etiologic studies in Southeast Asia revealed that DHF occurred in areas simultaneously endemic with dengue viruses of two or more serotypes (Table 1). In Thailand where DHF has been endemic with a 3- to 5-year cycle of large epidemics, three or four dengue serotypes were isolated annually from cases of DHF [13]. DEN2 has been predominant for long periods with fluctuation in the proportion of different serotypes. In recent years, DEN3 has been the predominant serotype [38].

Epidemiological studies have shown a strong association between the occurrence of DHF/DSS with repeated or secondary infection [13]. With well-defined cases of DHF, the

proportion of DHF/DSS patients with secondary infection is about 85 to 99%. Those who contracted DHF during primary dengue infection are mainly infants under the age of 1 year, all of whom possessed passive dengue antibody from their mother [10]. With these findings, it has been postulated that antibody-dependent immune enhancement was responsible for the development of DHF [11,12].

**Table 1. Dengue Hemorrhagic Fever in Southeast Asia**

Place	Year of Occurrence	Serotype
Philippines-Manila	1954	DEN1, DEN2
	1956	DEN3, DEN4
Thailand-Bangkok	1958	DEN3, DEN4
Vietnam-Hanoi Ho Chi Min City	1960	DEN2, DEN1
	1960	DEN1, DEN2
Singapore	1960	DEN3, DEN4
Kampuchea	1961	DEN1, DEN4
Laos	1962	?
Malaysia-Penang	1962	DEN4, 3, 2, 1
India-Calcutta	1963, 1964	DEN2
Indonesia-Jakarta	1968	?
	1976	DEN1, 3, 4
Myanmar-Yancon	1970	DEN2
Sri Lanka	1966	?
Maldives	1988	?

Based on References 16 and 22 and WHO Monograph on Dengue/Dengue Hemorrhagic Fever, No. 22, 1993.

A prospective study in Thailand has shown that secondary infection with DEN2 following primary infection with DEN1 is the highest risk sequence for the development of DHF [31]. A recent long-term study conducted in Myanmar also showed that secondary infection with DEN2 is the highest risk factor for the development of DSS [34]. These findings are in accordance with the sequential infections of DEN2 after DEN1 that led to the outbreak of DHF in Cuba [8].

Recent studies of the molecular evolution of DEN2 virus in the Americas have shown that Southeast Asian DEN2 genotypes have displaced the native American DEN2 genotype in Brazil, Columbia, Mexico, and Venezuela and are responsible for the DHF epidemics in these countries. The researchers concluded that the Southeast Asian DEN2 strain is the most virulent genotype in terms of its potential to cause DHF/DSS [28].

A recent study comparing the genotype of DEN2 viruses isolated from mild DF and from DHF/DSS cases in Thailand revealed that DEN2 viruses circulating in Thailand either from DF or DHF cases belong to two distinct genotypic groups among the five subgroups of DEN2 strains. This supports the view that they (DEN2, isolated from DF or DHF in Thailand)

arose from a common progenitor and share the potential to cause severe disease [29]. This suggests that both secondary infection and a particular DEN2 strain (e.g., Southeast Asian) are important factors in the occurrence of DHF.

Although there are a great number of unresolved issues regarding the pathogenic mechanisms of DHF/DSS, some associated or risk factors have been identified and are summarized in Table 2. Age appears to be an important factor as classic DHF/DSS is almost exclusively confined to children, although there have been increasing reports of adult cases, particularly in new areas of emergence such as in Cuba. When adult cases with DF were excluded, classic DHF cases with plasma leakage were more common in children than in adults [18]. The nutritional status of most children who contract DHF/DSS is also better than children with other infectious disease [35]. A study on the genetic determinant of the hosts has shown some association between DSS and HLA-AA [4]. Gender may also be another host factor since shock and death occur more frequently in female compared to male children [10].

**Table 2. Risk Factors for DHF/DSS**

---

**Risk Factors: Hosts**

**Age** Children are more prone to develop DHF than adults.

**Gender** Shock and death occur more frequently in female than in male children.

**Nutrition** DHF/DSS is associated more with well-nourished than malnourished children.

**Race** Black people are less susceptible to shock syndrome than are White [9] and Asian people since there has been no report of DHF in Africa [8].

**Genetics** An association of DSS cases with some HLA types.

**Risk Factors: Viral/Immunity**

DHF occurs in areas of dengue endemicity with multiple serotypes.

**Sequential epidemic of different dengue serotypes.** Secondary infection with DEN2 is the highest risk in Thailand while DEN3 is observed in Malaysia and Indonesia.

**Viral strain/genotypes.** The southeast Asian DEN2 genotype is most virulent in terms of its potential to cause DHF/DSS (in association with secondary infection).

---

# Pathogenesis

Understanding the pathogenesis of DHF is one of the most important subjects in dengue research and leads directly to more effective patient care and disease prevention. Although the pathogenesis of DHF is not yet well-defined, available data strongly suggest that it has immunopathologic mechanisms [10,12]. Besides epidemiological data, the clinical profile of a short period of shock followed by a rapid and uneventful recovery, together with pathologic evidence of nonsevere tissue damage without inflammatory change in the blood vessels, support an altered immunological process rather than tissue destruction through a direct effect of the virus [1,21].

The association of DHF with secondary dengue infection in older children and primary infection in infants with passive dengue antibody from their mothers led Halstead to propose the concept of antibody-dependent immune enhancement (ADE) [11,12]. He suggested that during the second infection with a heterotypic dengue infection which differed from the primary one, preexisting antibodies from the first infection that failed to neutralize, may instead enhance viral uptake and replication in the mononuclear phagocytes. Such infected cells may then become the target of an immune elimination mechanism which can trigger the production of mediators and activation of complement and the clotting cascade, and eventually produce DHF [12]. The role of ADE has been mainly studied *in vitro* [11]. Kliks *et al.* reported strong evidence to support the correlation between the preexistence of antibodies to dengue virus and the occurrence of DHF in infants [19].

Other researchers studying the role of cell-mediated immune response have proposed that, in secondary infection, antibodies to dengue virus form dengue virus-antibody complexes and enhance dengue virus infection of monocytes and macrophages as proposed by Halstead, but have emphasized the role of T cells and cytokines [20,22]. IL-1 to 6, TNF, and interferon (IFN) gamma and other chemical mediators, e.g., C3a, C5a, and histamine have been studied. Except for IL-1, these cytokines and mediators have been found to be increased in DHF [20]. These researchers have hypothesized that a rapid increase in the levels of these mediators — particularly of IL-2, IL-6, IFN gamma, PAF, C3a, C5a, and histamine — coupled with the synergistic activity of these mediators induce malfunction of vascular endothelial cells. This leads to plasma leakage and shock and derangements of the coagulation system which may result in hemorrhagic manifestations [20].

# Conclusions

The unresolved issues in DHF are mainly related to its pathogenesis, which is complicated and involves various branches of medical sciences. Despite over four decades of research, DHF remains poorly understood primarily because there are no advanced laboratory methods available in the areas of disease endemicity and there are no existing animal disease models. It is hoped that with modern science and technology, along with the cooperation from all disciplines concerned, the problems can be solved. The understanding of the pathogenesis of this disease will benefit not only patient care but will aid in the implementation of the live attenuated tetravalent vaccine that has been developed in Thailand and is currently being manufactured [2].

# References

1. Bhamarapravati N, Tuchinda P, Boonpaknavik V. Pathology of Thailand hemorrhagic fever, a study of 100 autopsy cases. *Ann Trop Med Parasitol* 1967;61:500-10.
2. Bhamarapravati N, Yoksan S. Live-attenuated tetravalent dengue vaccine. In: Gubler DJ, Guno G, editors. *Dengue and Dengue Hemorrhagic Fever*. Wallingford (UK), New York: CAB International; 1997. p. 367-77.
3. Burke DS, Nisalak A, Johnson DE, Scott RM. A prospective study of dengue infections in Bangkok. *Am J Trop Med Hyg* 1983;38:172-80.
4. Chiewsilp P, Scott RM, Bhamarapravati N. Histocompatibility antigens and dengue hemorrhagic fever. *Am J Trop Med Hyg* 1981;30:1100-5.
5. Edelman R, Nimmannitya S, Colman RW, Talamo RC, Top FH Jr. Evaluation of the plasma kinin system in dengue hemorrhagic fever. *J Lab Clin Med* 1975;86(3):410-21.
6. Fischer DB, Halstead SB. Observations related to pathogenesis of dengue hemorrhagic fever: V. Examination of age specific sequential infection rate using a mathematical model. *Yale J Biol Med* 1976;42:329.
7. George R, Lum LCS. Clinical spectrum of dengue infection. In: Gubler DJ, Guno G, editors. *Dengue and Dengue Hemorrhagic Fever*. Wallingford (UK), New York: CAB International; 1997. p. 89-113.
8. Gubler DJ. Dengue and dengue hemorrhagic fever: its history and resurgence as a global public health problem. In: Gubler DJ, Guno G, editors. *Dengue and Dengue Hemorrhagic Fever*. Wallingford (UK), New York: CAB International; 1997. p. 1-22.
9. Guzman MG, Kouri GP, Bravo J, Soler M, Vazquez S, Morier L. Dengue hemorrhagic fever in Cuba. A retrospective seroepidemiologic study. *Am J Trop Med Hyg* 1990;42:979-84.
10. Halstead SB, Nimmannitya S, Cohen S. Observations related to pathogenesis of dengue hemorrhagic fever: IV. Relation of disease severity to antibody response and virus recovered. *Yale J Bio Med* 1970;42:311-28.
11. Halstead SB, O'Rourke EJ. Dengue viruses and mononuclear phagocytes. Infection enhancement by non neutralizing antibody. *J Exp Med* 1977;46:201-17.
12. Halstead SB. The pathogenesis of dengue: Challenges to molecular biology. *Science* 1988;239:476-81.
13. Hoke CH, Nimmannitya S, Nisalak A, Burke DS. Studies on dengue hemorrhagic fever (DHF) at Bangkok Children's Hospital 1962-1984. *Proceedings of International Conference on Dengue/Dengue Hemorrhagic Fever*; 1983; Kuala Lumpur.
14. Hammon W. McD, Rudnick A, Sather GE. Viruses associated with epidemic hemorrhagic fevers of the Philippines and Thailand. *Science* 1960;131:1102-3.
15. Innis BL, Khin MM, Nisalak A, et al. Acute liver failure is one important cause of fatal dengue infection. *Southeast Asian J Trop Med Public Health* 1990;21(Suppl):695-96.
16. Jatanasen S, Thoncharoen P. Epidemiology of dengue hemorrhagic fever in Southeast Asia. *Monograph on Dengue/dengue hemorrhagic fever*, World Health Organization (Regional Publication SEARO No. 22) 1993;23-30.
17. Kalayanaroj S, Vaughn DW, Nimmannitya S, et al. Early clinical and laboratory



- indicators of acute dengue illness. *J Infect Dis* 1997;176:313-21.
18. Kouri GP, Guzman MG, Brano JR, Triana C. Dengue hemorrhagic fever/dengue shock syndrome: lessons from the Cuban epidemic. *Bull World Health Organ* 1989;67:375-80.
  19. Kliks SC, Nimmannitya S, Nisalak A, Burke DS. Evidence that maternal dengue antibodies are important in the development of dengue hemorrhagic fever in infants. *Am J Trop Med Hyg* 1988;38(2):411-19.
  20. Kurane I, Innis BL, Nisalak A, et al. Human T cell responses to dengue virus antigens. Proliferative responses and interferon gamma production. *J Clin Invest* 1989;83:506-13.
  21. Kurane I, Innis BL, Nimmannitya S, et al. Human immune responses to dengue viruses. *Southeast Asian J Trop Med Public Health* 1990;21:658-62.
  22. Lam SK, Pang T, Umenai T. Monograph on Dengue/dengue hemorrhagic fever in western Pacific region, World Health Organization (Regional Publication SEARO No. 22) 1993;31-38.
  23. Malasit P. Complement and dengue hemorrhagic fever/shock syndrome. *Southeast Asian J Trop Med Public Health* 1987;18(3):316-20.
  24. Mittrakul C. Bleeding problem in dengue hemorrhagic fever: platelets and coagulogram changes. *Southeast Asian J Trop Med Public Health* 1987;18(3):407-12.
  25. Nimmannitya S. Clinical spectrum and management of dengue hemorrhagic fever. *Southeast Asian J Trop Med Public Health* 1987;18(3):392-7.
  26. Nimmannitya S, Thisyakorn U, Hemsrichart V. Dengue haemorrhagic fever with unusual manifestations. *Southeast Asian J Trop Med Public Health* 1987;18(3):398-406.
  27. Pongpanich B, Kumponpant S. Studies of dengue hemorrhagic fever: V. Hemodynamic studies of clinical shock associated with dengue hemorrhagic fever. *J Pediatr* 1973;83:1073-7.
  28. Rico-Hesse R, et al. Molecular evolution and pathogenesis of dengue 2 viruses. In: Saluzzo JF, Dodet B, editors. *Factors in the Emergence of Arboviruses Disease*. Paris: Elsevier; 1997. p. 103-8.
  29. Rico-Hesse R, Harrison ML, Nisala RA, et al. Molecular evolution of dengue type 2 virus in Thailand. *Am J Trop Med Hyg* 1998;58(1):96-101.
  30. Rosenberg SA, Lotze MT, Muul LM, et al. Observation on the systemic administration of autologous lymphokine-activated killer cells and recombinant interleukin-2 to patients with metastatic cancer. *New Engl J Med* 1985;313:1485-92.
  31. Sangkawibha N, Rojanasuphot S, Ahandrik S. Risk factors in dengue shock syndrome. A prospective epidemiologic study in Rayong, Thailand: I. The 1980 outbreak. *Am J Epidemiol* 1984;120:653-69.
  32. Srichaikul T, Nimmannitya S, Artchararit N, Siriasawakul T, Sungpeuk P. Fibrinogen metabolism and disseminated intravascular coagulation in dengue hemorrhagic fever. *Am J Trop Med Hyg* 1977;26(3):525-32.
  33. Srichaikul T, Nimmannitya S, Sripaisam T, Kamolsilpa M, Pulgate C. Platelet function during the acute phase of dengue hemorrhagic fever. *Southeast Asian J Trop Med Public Health* 1989;20(1):91-125.
  34. Thein S, Augn MM, Shwe TN, et al. Risk factors in dengue shock syndrome. *Am J Trop Med Hyg* 1997;56(5):566-72.

35. Thisyakorn U, Nimmannitya S. Nutritional status of children with dengue hemorrhagic fever. *Clin Infect Dis* 1993;16:295-7.
36. Tuchinda M, Dhorrarintra B, Tuchinda P. Histamine content in 24 hour urine in patient with dengue hemorrhagic fever. *Southeast Asian J Trop Med Public Health* 1977;8:80-3.
37. Usawattanakul W, Nimmannitya S, Sarabenjawong K, Tharavanij S. Endotoxin and dengue haemorrhagic fever. *Southeast Asian J Trop Med Public Health* 1986;17:8-12.
38. Vaughn D. Personal communication. 1997.
39. *Dengue Hemorrhagic Fever: Diagnosis, Treatment, Prevention, and Control*. 2nd edition. Geneva: World Health Organization; 1997.



# Tick-borne Diseases: The Emergence of Human Granulocytic Ehrlichiosis

J. Stephen Dumler, M.D.

*The Johns Hopkins University School of Medicine, U.S.A.*

Human granulocytic ehrlichiosis (HGE) is an emerging tick-borne infection that has only recently been discovered. The story of HGE is remarkable for its investigation and identification in the absence of microbial cultivation methods and for the rapid identification of large numbers of infected patients. The reasons for the emergence of HGE are not completely understood but can be demonstrated to involve increasingly alert and well-trained health care practitioners, application of molecular microbiologic investigation methods, and the increasing abundance of ticks and their hosts in areas with significantly increasing human development and activity. Although HGE is easily treated if diagnosed early, and potentially fatal if untreated or undiagnosed, control measures for this disease and other tick-borne agents will be problematic unless habitats of humans and ticks are separated, or unless novel strategies for controlling ticks, tick-borne infectious agents, or tick-borne diseases are investigated and implemented.

# The Emergence of Human Granulocytic Ehrlichiosis

After 4 years of fascinating discoveries and the dissemination of information concerning the newly-identified disease then called human ehrlichiosis, physicians and health care practitioners were becoming prepared to identify and treat patients presenting with the new entity. Despite this forewarning, physicians were confused when in June 1990, an 81-year-old man from Wisconsin presented with severe myalgias, headache, and a high fever 2 weeks after a tick bite. Nearly one-half of his peripheral blood neutrophils contained small aggregates of bacteria, later recognized as morphologically indistinguishable from the known cause of human ehrlichiosis. Despite intensive efforts, he died. Johan S. Bakken, M.D., an infectious disease specialist at the Duluth Clinic in Minnesota, recognized the clinical and morphological similarities to human ehrlichiosis, but was confused because human ehrlichiosis had not been previously identified in Minnesota or Wisconsin and because the suspected tick vector of human ehrlichiosis was not present in that geographic region. Dr. Bakken enlisted the help of David H. Walker, M.D., Chairman of the Department of Pathology at the University of Texas Medical Branch (UTMB) in Galveston, and a known expert in rickettsial diseases. The author, then a postdoctoral fellow in Dr. Walker's department, was assigned to further pursue these new clinical observations. All studies performed on the blood and tissues of this patient yielded negative results when assayed for evidence of infection by the now known agent of human monocytic ehrlichiosis (HME), *Ehrlichia chaffeensis*, and the specific etiologic agent remained a poorly defined mystery [14,51].

Dr. Bakken continued to identify similar patients in the ensuing 3 years, archiving fresh blood and serum samples from suspected cases, and instituting curative doxycycline therapy early in the course of illness. In June 1992, a blood sample was obtained from another man who presented with a similar, but milder, illness. As had been previously planned, this sample was assessed for the presence of other potential infectious agents by a thorough clinical microbiology laboratory examination without definitive results. Sheng-Min Chen, M.D., a new postdoctoral fellow in Dr. Walker's laboratory at UTMB, successfully amplified the 16S ribosomal RNA from the causative agent in blood using a set of PCR primers that are conserved for all eubacteria [14]. Dr. Chen then sequenced the amplified gene and determined by phylogenetic comparison with 16S rRNA genes from other bacteria, that the sequence from the new human ehrlichia was nearly identical to two veterinary *Ehrlichia* species, *E. equi* and *E. phagocytophila*, both ehrlichiae that infect neutrophils, but known as infectious agents of California horses and European ruminants, respectively [17,50].

Identical nucleic acids were then amplified from archived and freshly obtained blood samples of suspected patients using specific PCR and the convalescing patients were shown to develop antibodies that reacted with *E. phagocytophila* and *E. equi*, but not with *E. chaffeensis* [2]. Finally, antibodies to *E. phagocytophila* and *E. equi* were used to demonstrate the presence of the etiologic agent in the postmortem tissues of the index case [2,51]. The entire investigation was accomplished within 3 years by a small, unfunded group of investigators and clinicians without benefit of cultivation of the causative organism.

The disease was named human granulocytic ehrlichiosis (HGE) to identify the predominant host cell type and to distinguish it from human monocytic ehrlichiosis identified in other geographic regions [2,14,17,50]. At the time, insufficient evidence was available to identify the causative agent as a new species.

# HGE: The Disease and Non-Disease

Since that time, HGE has been identified in over 500 persons in at least 11 states and in 8 European countries [19,51]. Most cases in the United States have been identified in the Northeast and upper Midwest. Because the predominant tick vector is an *Ixodes* species tick [2,33,41], co-transmission and evidence of co-infection by *Borrelia burgdorferi* or *Babesia microti* is present in between 4 and 20% of cases [3,11,18,22,34,37,38,41,42,58,59]. Men are affected about twice as often as women, and the disease is identified in patients with a median age of 43 to 60 years, which is older than the median age of patients with either Lyme disease or Rocky Mountain spotted fever [1,4,19]. Patients present with fever, headache, myalgias, and malaise, while other manifestations such as gastrointestinal, respiratory, or central nervous system involvement occur in 20 to 50% of patients. Rash, a hallmark of tick-borne diseases, occurs in less than 11% of infected persons.

Because HGE presents most often as an influenza-like illness with no other differentiating findings, diagnosis can be very difficult [1,4,19]. Laboratory findings which aid in diagnosis include leukopenia, thrombocytopenia, and evidence of mild-to-moderate hepatocyte injury. More specific laboratory tests include simple examination of peripheral blood smears for typical intracytoplasmic morulae in neutrophils (aggregates of ehrlichiae) which is relatively insensitive but rapid; demonstration of the presence of HGE agent nucleic acids in blood which is relatively sensitive and rapid, but requires an advanced technology laboratory; and seroconversion which is very sensitive, but confirms infection only during convalescence [17,19,50].

By 1996, four deaths associated with HGE were identified, three of which resulted from opportunistic infections that developed after the initial ehrlichial infection. Such a situation was known to occur in European ruminants with *E. phagocytophila* infection that resulted from a multifactorial defect in T cell, B cell, and neutrophil functions [8,10,53-56]. How often such severe infections occurred was not clear; how often HGE occurred also was not clear. Analysis of severity revealed that most patients who became ill required hospitalization and that approximately 5 to 7% of these patients required intensive care [4]. Of particular concern currently is the development in these patients of opportunistic infections [2,4,27,51], adult respiratory distress syndrome [57], or a septic shock-like syndrome [1,2]. None of the patients who died had received timely effective therapy whereas the majority of cured patients had received doxycycline early in the course of illness. A retrospective analysis of cases identified in northwestern Wisconsin revealed a disease incidence of 14 to 16 cases per 100,000 in the most endemic counties between 1990 and 1994; in 1994 alone, the incidence was as high as 58 cases per 100,000 in one county [4], a figure that is similar to the incidence of Lyme disease in that same region.

A prospective serologic surveillance was established in northwestern Wisconsin where the majority of the cases had been identified [5]. Enrolled individuals who were healthy at the time of their visit to local outpatient health care facilities revealed that nearly 15% had been infected with the HGE agent at some time. While these numbers are particularly high from an area that must be considered highly endemic, figures of a magnitude that greatly

exceed the numbers of identified cases were also found in New York State [58], Connecticut [34], Maryland [unpublished data], California [23], Sweden [18], Norway [3], and Switzerland [11] as well as other locations. These data seemed to indicate that approximately 10 to 20 subclinical or unrecognized infections occur for each case that is diagnosed. Thus, it is likely that HGE is generally a relatively mild illness, but under some conditions may lead to severe disease and mortal complications.



# Why Now and Here? The Ecology of HGE

The initial descriptions of the epidemiology of HGE implicated ticks as the vector, and strongly suggested that *Ixodes scapularis*, the black-legged tick, was the predominant vector in the Eastern United States [2,41]. Among documented cases, nearly 75% of patients had a recent tick bite [1,4]. These regions, however, are well recognized for ticks which transmit agents that cause infections such as Lyme disease and babesiosis. It was unclear, therefore, whether HGE was a new disease or simply a newly-recognized disease. Retrospective serologic analyses showed that infection in humans occurred at least as early as the mid-1980s and that infection in ticks and mice was also present in the early and mid-1980s in the absence of recognized human disease [12,41].

There is a long historical precedent for the existence of nonhuman infection by the *E. phagocytophila* group of bacteria. In 1932, MacLeod described tick-borne fever caused by an infectious agent of sheep that could be propagated by serial inoculation of infected blood and suggested a rickettsial etiology [25]. In 1938, Tyzzer described an infectious agent of meadow voles that was morphologically indistinguishable from the *E. phagocytophila* group of ehrlichiae; these agents were propagated through small rodent hosts by passage of blood or spleen [49]. By the 1980s, infections of animals by *E. phagocytophila* or *E. equi* were well recognized but were considered distinct and geographically localized; little was known concerning the ecology and natural maintenance of the infectious agent [44].

With the discovery of *E. chaffeensis* and molecular classification of *Ehrlichia* species, it became clear that *E. phagocytophila* and *E. equi* were closely related [50]. Thereafter, the HGE agent was identified by molecular means and cultivated by animal passage and tissue culture methods [2,14,24]. Additional serological, genetic, and biological data strongly suggested the identity of *E. phagocytophila*, *E. equi*, and the HGE agent, despite perceived clinical and geographical discrepancies [6,19,31,47]. It was recognized very early that *E. phagocytophila* was transmitted by nymphal and adult stage *Ixodes ricinus* ticks [4,48]. It was not until HGE, and its causative agent were discovered and also shown to be a cause of equine and canine granulocytic ehrlichiosis in the Eastern United States and Europe, however, that it was clear that the causative agent of HGE, as well as *E. equi*, were also transmitted by the genetically similar *Ixodes* species, *I. scapularis*, and *I. pacificus*, respectively [26,40,43,48].

## *Ticks, Mice, and HGE*

Between 6 and 91% of adult *I. scapularis* ticks examined from areas with known HGE cases contained *E. phagocytophila* group nucleic acids [16,33,41,45,48]. Similarly, up to a minimum of 8.3% of *I. pacificus* ticks in one region of California were found to contain *E. equi* DNA; these collections correspond to regions where equine granulocytic ehrlichiosis or HGE have been documented [7,23]. Dog ticks (*Dermacentor variabilis*) may be competent at transmission, but seem to rely upon co-feeding with *I. scapularis*, and are not found infected in nature [35]. MacLeod studied the transmission of *E. phagocytophila* by *I. ricinus* ticks and determined that newly emerged larvae are noninfectious [30]; thus, transovarial

transmission is probably inefficient. No other data concerning transovarial transmission are available for the *E. phagocytophila* group; however, Magnarelli *et al.* have demonstrated transovarial passage in *I. scapularis* of ehrlichiae that share antigens with *E. canis*, an observation that suggests an alternate method for maintenance of infected tick populations [32].

The major hosts for immature stages of *I. scapularis* ticks are small mammals, in particular the white-footed mouse, *Peromyscus leucopus*. Telford demonstrated that 20 to 33% of *I. scapularis* larvae that fed upon an experimentally-infected mouse were competent at transmission to other mice after molting into nymphs, and that the prepatent interval after tick repletion was as short as 2 to 4 days [48]. The interval during which laboratory mice could be determined to be infected was about 40 days. Walls *et al.* tested *P. leucopus* and other small mammals trapped in Minnesota during June 1994 and showed that 10% were infected, 10% had antibodies, and 2.5% had both, consistent with an interval of patent infection followed by immune induction and loss of infectivity [52]. By controlled laboratory experiments, Bunnell has more closely defined the infectious interval to be less than 21 days, effectively limiting the period of transmissibility in nature [13]; however, DesVignes and Fish provided experimental evidence that only one of every two bites by infected ticks results in transmission [16]. The percentage of infected *I. scapularis* ticks in one region of Connecticut increased from 1.6% in nymphs to 12.5% in adults, whereas *B. burgdorferi* from the same area infects 53% and 61% of nymphs and adults, respectively [29]. These data suggest that the rate of increasing infection among adult *I. scapularis* with the HGE agent as compared with that for *B. burgdorferi* that are transmitted by the same tick vector into the same reservoir host indicate a lower transmission efficiency in small rodents and potentially implicate alternate reservoir hosts or co-pathogen influenced transmission dynamics [29].

Other potential reservoir hosts that should be considered include voles, chipmunks, squirrels, and small mammals that are natural hosts for *I. scapularis* immature stages [52]. It has been known for years that tick-borne fever caused by the HGE agent synonym *E. phagocytophila* can establish low-grade, persistent infection in ruminants, including deer [10,30,36]. Such animals have been suggested to be important reservoirs of infection in pastures in which sheep, goats, or cattle are kept, and deer may be the natural reservoir from which infection is propagated into domesticated species. The role of deer as reservoirs of tick-borne disease agents is still controversial. At a minimum, deer provide an appropriate host for adult stage ticks that, once replete, will not bite humans. When assayed as sentinels for HGE agent activity in ticks, 8% of white-tailed deer from Wisconsin had serologic evidence of infection, while 15% had HGE agent DNA present in their blood [9]. Chronic, persistent infection in deer and some other ruminants is thought to be either subclinical or very mild, thus allowing the existence of long-term reservoirs from which infected ticks may be derived.

Factoring all of the prior ecological information together, it becomes clear that *E. phagocytophila* group ehrlichiae are at a minimum, maintained in a basal state via a rodent-tick cycle that would provide a continuous source of subadult infected ticks. These low level infections in tick populations would provide a continuous source from which larger

mammals, perhaps hoofed mammals such as deer, initially acquire the infectious agent and become persistently infected. Large animals that are persistently infected may in turn serve as amplifying sources from which infectious adult ticks are derived since co-feeding with nymphs and adults does occur.

This hypothesis is consistent with the observation that most human infections occur during the mid-summer months when the small, inapparent nymphal ticks are most active, and that a smaller number of human cases are observed during the fall when the more easily detected adult stages are active [4]. An interesting decline in human infections is observed in August and September when neither nymphs nor adults are particularly active. Moreover, this comparison underscores that transmission only occurs when infected tick activity and human activity converge [21]. This implies two important points: first, what determines tick activity, and two, what determines human activity?

# The Human Desire for Natural Beauty: A Wolf in Sheep's Clothing

Until relatively recently, the northeastern regions of the United States were largely agrarian areas since the time of the European settlements. As farming activity diminished in these areas within the last 80 years, much of the land was reclaimed by forests and fields, all ecosystems that encourage repopulation with peridomestic animal species such as field mice and deer. The absence of significant predators has allowed an unfettered proliferation of deer such that populations are higher than before European colonization. The repopulation of "wild" niches with deer and other small mammals allows the reconstitution of other niches that harbor blood-sucking arthropods, in particular, ticks. In fact, it is likely that both small and large mammals are required for *Ixodes* species ticks, since the different stages have a predilection for different mammalian species [20,21].

These regions have become popular retreats for increasingly mobile Americans who flee urban problems for the more serene and natural surroundings of the suburbs and developing rural areas — areas that were previously rarely visited by humans. Thus, humans are now exposed to the wonders and perils that natural ecosystems can provide to a degree unprecedented in the past. The re-establishment of these now developing previously agricultural regions with ecosystems that support ticks has paralleled the rapid increase in the tick-borne disease of humans, Lyme borreliosis, and now HGE.

Is increased exposure the only explanation? Probably not, since the geographic regions in which *B. burgdorferi*-infected ticks are found has expanded rapidly since testing began. The expansion of tick-borne agents is also dynamic and depends upon many factors, in particular the habits and patterns of their predominant host species [20,21]. Environmental factors that affect any of the links important to the ecosystem of *I. scapularis*, for example the abundance of acorns, the predominant food source for *P. leucopus*, will affect the abundance of ticks and consequently the probability of human tick-borne infections related to tick species that rely upon mice [28]. Interruption of this important cascade of obligatory events might provide opportunities to control HGE or Lyme disease. Attempts to affect tick abundance and the potential for human transmission, however, have generally failed [15,60], although new strategies are continually developing.

Another poorly investigated mechanism which could influence tick abundance concerns the microbiotic flora of these arthropods. A number of saprophytic, symbiotic, or "nonpathogenic" microorganisms survive within the tick. In the past, many assumed that such microorganisms were relatively inert and simply "along for the ride." Recent observations, however, have conclusively shown that obligate intracellular bacteria in the genera *Rickettsia* and *Wolbachia* have the potent ability to influence whole populations of insects by induction of parthenogenesis, cytoplasmic incompatibility, and interference with the growth of other endogenous species as mechanisms to ensure bacterial survival [46]. A remarkable example of the importance of these organisms is found with the symbiont *Rickettsia peacockii* found in *Dermacentor andersoni* ticks [39]. This rickettsia was previously known as the "east-side agent" because its prevalence on the east side of the Bitterroot Valley in Montana coincided with a marked reduction in the presence of the

pathogenic *Rickettsia rickettsii* and a marked reduction in prevalence of Rocky Mountain spotted fever in the same area [39]. This remarkable feat is accomplished because tick tissues infected with *R. peacockii* cannot sustain infection by another rickettsia, including the highly virulent *R. rickettsii*. The avirulence of *R. peacockii* is speculated to result from a simple molecular modification in the major adhesin protein for spotted fever group rickettsiae, the rickettsial outer membrane protein A (rOmpA) [39]. This important adhesin protein is truncated in *R. peacockii* resulting from a single mutation that yields an early terminator codon. Whether correlates of this situation exist for *Borrelia* or *Ehrlichia* is not known, but *Wolbachia pipientis* that is associated with significant modifications in some arthropod populations is genetically very similar to species now placed in the *Ehrlichia* genus [46,50].

Finally, advances in science have led to an increasing ability to recognize new clinical entities. That HGE existed prior to the index case of 1990 is proven. Its generally mild clinical presentation probably contributed to physician oversight; in severe forms, it was not identified because of the lack of specific clinical features [2,17]. Once identified, however, diagnostic tools were rapidly developed, disseminated, and implemented, and now provide compelling data that strongly suggest that the emergence of HGE should be largely attributed to increased clinical awareness [1,4,58,59]. In spite of this, knowledgeable physicians continue to claim that HGE is new; it was not seen prior to 1990 in Wisconsin or 1994 in New York State. The degree to which HGE has “emerged” cannot be attributed to any one, but to all of these components.

# Treatment, Control, and Prevention of HGE

HGE has only been recognized for several years, and the mainstay for management has been identification of infected individuals and early institution of appropriate antimicrobial therapy. The results are almost always good and in the vast majority of patients, tetracyclines result in a clinical cure within several days [1,4]. Adverse outcomes usually result from late diagnosis or delayed therapy [4,51]; thus, the widespread use and development of highly effective early diagnostic methods and continued health care practitioner education is warranted. Reliable tools for epidemiologic investigation will enable a better understanding of the populations at risk and will focus attention toward problem regions or behaviors. The limited seroepidemiologic data available, however, suggests that a substantial number of people are at risk and that at least some will develop severe complications and may die [1,4,34,48,51,59]. Avoidance of tick-infested regions would be advantageous, but the political and recreational preferences of humans are unlikely to change to accommodate the natural distributions of tick-bearing animals or to intervene with reduction of tick-bearing animal populations in areas with increasing human habitation. Historically, efforts to reduce tick abundance by acaricide treatments have not worked well, and computer models suggest that short-term solutions yield only short-term success [15]. Thus, a variety of strategies could be considered to control the infection or the infectious agent before the opportunity for human infections arises. Initially a definition of the populations at risk and the degree of risk could be modeled by careful field study using tools such as geographical information systems. When approximations of risky environments are devised, interventions that would focus upon disease prevention or prevention of transmission in high-risk areas could be investigated. Specific goals might include the development of effective vaccines for use in humans and animals that could interrupt infection despite tick transmission or could potentially interrupt the natural tick-mammal transmission cycle. Another novel means for control would require investigation of strategies to interfere with ongoing natural propagation of pathogenic species in ticks by introduction of avirulent competing symbionts or avirulent mutants of pathogenic tick-borne agents.

Regardless which strategies are employed, tick-borne diseases are likely to be a part of our lives for years to come. These diseases will not spread explosively nor threaten our existence with epidemics of hemorrhagic fevers, but they will continue to linger, smolder, and cause chronic and remitting disease or the occasional rapid death; tick-borne pathogens will adapt and re-emerge given the opportunities that unbalanced ecological changes bring and will again strike after maneuvers that we initiate for the sake of improving our lives.

# References

1. Aguero-Rosenfeld M, Horowitz HW, Wormser GP, et al. Human granulocytic ehrlichiosis (HGE): A series from a single medical center in New York State. *Ann Int Med* 1996;125:904-8.
2. Bakken JS, Dumler JS, Chen SM, Eckman MR, Van Etta LL, Walker DH. Human granulocytic ehrlichiosis in the upper midwest United States. A new species emerging? *JAMA* 1994;272:212-8.
3. Bakken JS, Krueth J, Tilden RL, Dumler JS, Kristiansen BE. Serological evidence of human granulocytic ehrlichiosis in Norway. *Clin Microbiol Infect Dis* 1996;15:829-32.
4. Bakken JS, Krueth J, Wilson-Nordskog C, Tilden RL, Asanovich K, Dumler JS. Clinical and laboratory characteristics of human granulocytic ehrlichiosis. *JAMA* 1996;275:199-205.
5. Bakken JS, Goellner P, Mattson S, et al. Seroprevalence of human granulocytic ehrlichiosis (HGE) among residents in Northwestern Wisconsin. 37th International Conference on Antimicrobial Agents and Chemotherapy; Toronto, Canada; Sept. 28 – Oct. 1, 1997.
6. Barlough JE, Madigan JE, DeRock E, Dumler JS, Bakken JS. Protection against *Ehrlichia equi* is conferred by prior infection with the human granulocytotropic ehrlichia (HGE agent). *J Clin Microbiol* 1995;33:3333-4.
7. Barlough JE, Madigan JE, Kramer VL, et al.. *Ehrlichia phagocytophila* genogroup rickettsiae in Ixodid ticks from California collected in 1995 and 1996. *J Clin Microbiol* 1997;35:2018-21.
8. Batungbacal MR, Scott GR, Burrells C. The lymphocytopaenia in tick-borne fever. *J Comp Pathol* 1982;92:403-7.
9. Belongia EA, Reed KD, Mitchell PD, et al. Prevalence of granulocytic *Ehrlichia* infection among white-tailed deer in Wisconsin. *J Clin Microbiol* 1997;35:1465-8.
10. Brodie TA, Holmes PH, Urquhart GM. Some aspects of tick-borne diseases of British sheep. *Vet Rec* 1986;118:415-8.
11. Brouqui P, Dumler JS, Lenhard R, Brossard M, Raoult D. Serologic evidence of human granulocytic ehrlichiosis in Europe. *Lancet* 1995;346:782-3
12. Bunnell JE, Dumler JS, Childs JE, Glass GE. Retrospective serosurvey for antibodies reactive to the HGE agent in *Peromyscus leucopus* from Baltimore, Maryland. *J Wildl Dis* 1998;34:179-81.
13. Bunnell JE, Trigiani ER, Glass GE, Dumler JS. Assessment of a murine model of human granulocytic ehrlichiosis (HGE) (abstract). In: Programs and Abstracts of the Thirteenth Sesqui-Annual Meeting of the American Society for Rickettsiology, Champion, Pennsylvania; September 21-24, 1997; Abstract no. 95.
14. Chen S, Dumler JS, Bakken JS, Walker DH. Identification of a granulocytotropic *Ehrlichia* species as the etiologic agent of human disease. *J Clin Microbiol* 1994;32:589-95.
15. Cooksey LM, Haile DB, Mount GA. Computer simulation of Rocky Mountain spotted fever transmission by the American dog tick (Acari: Ixodidae). *J Med Entomol*

- 1990;27:671-80.
16. Des Vignes F, Fish D. Transmission of the agent of human granulocytic ehrlichiosis by host-seeking *Ixodus scapularis* (Acari:Ixodidae) in southern New York State. *J Med Entomol* 1997;34:379-82.
  17. Dumler JS, Bakken JS. Ehrlichial diseases of humans: emerging tick-borne infections. *Clin Infect Dis* 1995;20:1102-10.
  18. Dumler JS, Dotevall L, Gustafson R, Granström M. A population-based seroepidemiological study of human granulocytic ehrlichiosis (HGE) and Lyme borreliosis on the west coast of Sweden. *J Infect Dis* 1997;175:720-2.
  19. Dumler JS, Bakken JS. Human ehrlichioses. Newly recognized infections transmitted by ticks. *Ann Rev Med* 1998;49:201-13.
  20. Fish D, Dowler RC. Host associations of ticks (Acari: Ixodidae) parasitizing medium-sized mammals in a Lyme Disease endemic area of southern New York. *J Med Entomol* 1989;26:200-9.
  21. Fish D. Environmental risk and prevention of Lyme Disease. *Am J Med* 1995;8(Suppl 4A):2S-9S.
  22. Fingerle V, Goodman JL, Johnson RC, Kurtti TJ, Munderloh UG, Wilske B. Human granulocytic ehrlichiosis in Southern Germany: increased seroprevalence in high-risk groups. *J Clin Microbiol* 1997;35:3244-7.
  23. Fritz CL, Kjemtrup AM, Conrad PA, et al. Seroepidemiology of emerging tickborne infectious diseases in a northern California community. *J Infect Dis* 1997;175:1432-9.
  24. Goodman JL, Nelson C, Vitale B, et al. Direct cultivation of the causative agent from patients with human granulocytic ehrlichiosis. *N Engl J Med* 1996;334:209-15.
  25. Gordon WS, Brownlee A, Wilson DR, MacLeod J. "Tick-borne fever" (A hitherto undescribed disease of sheep). *J Comp Pathol Therap* 1932;45:301-7.
  26. Greig B, Asanovich KM, Armstrong PJ, Dumler JS. Geographic, clinical, serologic, and molecular findings of granulocytic ehrlichiosis in Minnesota and Wisconsin dogs, a likely zoonotic disease. *J Clin Microbiol* 1996;34:44-8.
  27. Hardalo CJ, Quagliarello V, Dumler JS. Human granulocytic ehrlichiosis in Connecticut: report of a fatal case. *Clin Infect Dis* 1995;21:910-4.
  28. Jones CG, Ostfeld RS, Richard MP, Schaubert EM, Wolff JO. Chain reactions linking acorns to gypsy moth outbreaks and Lyme disease risk. *Science* 1998; 279:1023-\*\*.
  29. Levin ML, Fish D. Incongruity in the natural cycles of the agents of HGE and Lyme disease (abstract). In: Programs and Abstracts of the Thirteenth Sesqui-Annual Meeting of the American Society for Rickettsiology, Champion, Pennsylvania; September 21-24, 1997; Abstract no. 101.
  30. MacLeod JR, Gordon WS. Studies in tick-borne fever of sheep. I. Transmission by the tick, *Ixodes ricinus*, with a description of the disease produced. *Parsitol* 1933;25:273-85.
  31. Madigan JE, Richter PJ, Kimsey RB, Barlough JE, Bakken JS, Dumler JS. Transmission and passage in horses of the agent of human granulocytic ehrlichiosis. *J Infect Dis* 1995;172:1141-4
  32. Magnarelli LA, Mather TN, Yeh M-T. Hemocytic rickettsia-like organisms in *Ixodes*



- scapularis*: transovarial and transstadial transmission. Can J Zool 1995;73:1380-3.
33. Magnarelli LA, Stafford KC III, Mather TN, Yeh M-T, Dumler JS. Hemocytic rickettsia-like organisms in ticks: serologic reactivity with antisera to ehrlichiae and widespread geographic distribution. J Clin Microbiol 1995;33:2710-4
  34. Magnarelli LA, Dumler JS, Anderson JF, Johnson RC, Fikrig E. Coexistence of antibodies to tick-borne pathogens of babesiosis, ehrlichiosis, and Lyme borreliosis in human sera. J Clin Microbiol 1995;33:2054-7.
  35. Mather TN, Mauel MJ, Carlton SJ, Coughlin RT, Massung RF. Vector competence of deer ticks (*Ixodes scapularis*) and American dog ticks (*Dermacentor variabilis*) for the HGE agent (abstract). In: Program and Abstracts of the 13th Sesqui-Annual Meeting of the American Society for Rickettsiology. Sept. 21-24, 1997; Champion, PA; Abstract no. 76.
  36. McDiarmid A. Modern trends in animal health and husbandry. Some infectious diseases of free-living wildlife. Brit Vet J 1965;121:245-57.
  37. Mitchell PD, Reed KD, Hofkes JM. Immunoserologic evidence of coinfection with *Borrelia burgdorferi*, *Babesia microti*, and human granulocytic *Ehrlichia* species in residents of Wisconsin and Minnesota. J Clin Microbiol 1996;34:724-7
  38. Nadelman KB, Horowitz HW, Chen HT, et al. Simultaneous human granulocytic ehrlichiosis and Lyme borreliosis. N Engl J Med 1997;337:27-30.
  39. Niebylski ML, Peacock MG, Schrupf ME, et al. Characterization of the East Side agent, a spotted fever group rickettsia infecting wood ticks, *Dermacentor andersoni*, in western Montana. In: Kazar J, Toman R, editors. Rickettsiae and Rickettsial Diseases, Proceedings of the Vth International Symposium. Bratislava, Slovak Republic: Slovak Academy of Sciences, Institute of Virology; 1996. p. 227-32.
  40. Johansson K-E, Pettersson B, Uhlén M, Gunnarsson A, Malmqvist M, Olsson E. Identification of the causative agent of granulocytic ehrlichiosis in Swedish dogs and horses by direct solid phase sequencing of PCR products from the 16S rRNA gene. Res Vet Sci 1995;58:109-12.
  41. Pancholi P, Kolbert CP, Mitchell P, et al. *Ixodes dammini* (*scapularis*) as a potential vector of human granulocytic ehrlichiosis. J Infect Dis 1995;172:1007-12
  42. Petrovec M, Furlan SL, Zupanc TA, et al. Human disease in Europe caused by a granulocytic *Ehrlichia*. J Clin Microbiol 1997;35:1556-9.
  43. Richter PJ, Kimsey RB, Madigan JE, Barlough JE, Dumler JS, Brooks DL. *Ixodes pacificus* as a vector of *Ehrlichia equi*. J Med Entomol 1996;33:1-5.
  44. Rikihisa Y. The tribe *Ehrlichieae* and ehrlichial diseases. Clin Microbiol Rev 1991;4:286-308.
  45. Schwartz I, Fish D, Daniels TJ. Prevalence of the rickettsial agent of human granulocytic ehrlichiosis in ticks from a hyperendemic focus of Lyme disease [letter]. N Engl J Med 1997;337:49-50
  46. Sinkins SP, Braig HR, O'Neill SL. *Wolbachia* superinfections and the expression of cytoplasmic incompatibility. Proc Royal Soc London — Series B: Biological Sciences 1995;261:325-30.
  47. Sumner JW, Nicholson WL, Massung RF. PCR amplification and comparison of

- nucleotide sequences from the *groESL* heat shock operon of *Ehrlichia* species. J Clin Microbiol 1997;35:2087-92.
48. Telford SR III, Dawson JE, Katavolos P, Warner CK, Kolbert CP, Persing DH. Perpetuation of the agent of human granulocytic ehrlichiosis in a deer tick-rodent cycle. Proc Natl Acad Sci USA 1996;93:6209-14.
  49. Tyzzer EE. *Cytoecetes microti* n. gen. n. sp. A parasite developing in granulocytes and infection in small rodents. Parasitology 1938;30:242-57.
  50. Walker DH, Dumler JS. The emergence of human ehrlichioses as human health problems. Emerg Infect Dis 1996;2:18-29.
  51. Walker DH, Dumler JS. Human monocytic and granulocytic ehrlichioses. Discovery and diagnosis of emerging tick-borne infections and the critical role of the pathologist. Arch Pathol Lab Med 1997;121:785-91.
  52. Walls JJ, Greig B, Neitzel DF, Dumler JS. Natural infection of small mammal species in Minnesota with the agent of human granulocytic ehrlichiosis. J Clin Microbiol 1997;35:853-5
  53. Woldehiwet Z, Scott GR. Immunological studies on tick-borne fever in sheep. J Comp Pathol 1982;91:457-67.
  54. Woldehiwet Z. The effects of tick-borne fever on some functions of polymorphonuclear cells of sheep. J Comp Pathol 1987;97:481-5.
  55. Woldehiwet Z. Depression of lymphocyte response to mitogens in sheep infected with tick-borne fever. J Comp Pathol 1987;97:637-43.
  56. Woldehiwet Z. Lymphocyte subpopulations in peripheral blood of sheep experimentally infected with tick-borne fever. Res Vet Sci 1991;51:40-3.
  57. Wong S, Grady LJ. *Ehrlichia* infection as a cause of severe respiratory distress [letter]. N Engl J Med 1996;334:273.
  58. Wong SJ, Brady GS, Dumler JS. Serological responses to *Ehrlichia equi*, *Ehrlichia chaffeensis*, and *Borrelia burgdorferi* in New York State. J Clin Microbiol 1997;35:2198-2205.
  59. Wormser GP, Horowitz HW, Nowakowski J, et al. Positive Lyme disease serology in patients with clinical and laboratory evidence of human granulocytic ehrlichiosis. Am J Clin Path 1997;107:142-7.
  60. Zaki MH. Selected tickborne infections. A review of Lyme disease, Rocky Mountain spotted fever, and babesiosis. NY State J Med 1989;89:320-35.



# Discussion

## Emerging Infectious Diseases

**Question for Dr. Swanepoel, National Institute for Virology, South Africa:** Can you enlarge upon human-to-human transmission of Ebola virus? Is it thought to be due to only needle stick injury or are there other routes of transmission?

**Answer by Dr. Swanepoel:** With the Kikwit outbreak, between households, those who became infected were the adults who tended to the sick people. Young children, those under the age of 10 years or so, who prepared the food, dispensed water, etc. did not become infected. Thus, contact with bloody waste, melena, diarrhea, vomitus, and so on seemed to be the key to transmission. There was no evidence of aerosol transmission.

**Question for Dr. Neira, World Health Organization, Switzerland:** Can you comment on the occurrence or nonoccurrence of human-to-human transmission of monkeypox virus? Does the smallpox vaccine provide effective protection against monkeypox and what is the relationship, if any, of the virus to smallpox virus?

**Answer by Dr. Neira:** In extensive studies during the 1970s and '80s, it was proven that the monkeypox virus infected humans, but that the occurrence of person-to-person transmission was very rare after three generations. That is why we were surprised with the 1995-96 outbreak to see cases beyond three generations. The answer to your question of whether smallpox vaccine protects against the monkeypox human species is yes. There was even some consideration in the past as to whether we should revaccinate with the smallpox virus to cover the transmission of monkeypox.

**Question for Dr. Lipkin, University of California, Irvine, U.S.A.:** Have you attempted to take human brain tissue or peripheral blood lymphocytes from patients with positive RT-PCR and infect animals known to be susceptible to see if you can show infection transmission?

**Answer by Dr. Lipkin:** We haven't done that. One group has tried to do that and claims to have been successful. Those results have not yet been confirmed.

**Question for Dr. McGowan, Emory University, U.S.A.:** In view of the demonstrated significance of variable infection control practices between facilities, has there been identification of those areas of infection control that are more of a problem, for example, clinical behavior versus sterilization and disinfection practices?

**Answer by Dr. McGowan:** The work we celebrate here has led to a long history of developing correct techniques, at least in developed countries, for carrying out sterilization procedures. By contrast, a long history since Lister has not produced tremendous success

in ensuring that clinical practices are all that they should be. Thus, I would think that the latter is the area we need to primarily focus on. One of the interests of the project I described is to try to quantitate the importance in the future of those factors I presented. To date, our Phase II data show that the relative importance of each of these things varies dramatically from center to center among the study hospitals. At one hospital, for example, when they found a particularly high degree of infection, they examined it further and found that their infection control practices needed modification. At another hospital, it seemed to be primarily due to a high prevalence of infection in the nursing homes and other places in the community that referred patients.

**Question for Dr. Lederberg, The Rockefeller University, U.S.A.:** Multiple antibiotic resistance is often currently mediated by 'resistance cartridges' in bacteria. These integrons transmit multiple resistances very efficiently. Can you comment on whether such 'resistance cartridges' are a new phenomenon or are they present in historical isolates as well?

**Answer by Dr. Lederberg:** I don't know of any information on the presence of these cartridges in historic isolates so the short answer to your question is that we just don't know. This raises a very puzzling question, however. We mustn't think that natural selection against bacteria, and therefore the means that they develop resistance to external agents, are unique to antibiotics. The struggle for existence in the face of a wide variety of chemical and physical hazards is a continuous one. What's new are the specific chemical identities that are being thrown at the bacteria. We don't know the immediate genesis of resistance nor do we know where the plasmid factors come from.

**Question for Dr. McGowan:** There are systems to regulate use of antibiotics in hospitals. Such systems often don't exist in the community. Can you suggest an improved approach to community control of antibiotics?

**Answer by Dr. McGowan:** The good news is that efforts are beginning. The bad news for me, however, is that they are not beginning well in the United States. Our colleagues in Spain and in Canada are beginning to show us the way and our colleagues in Scandinavia are providing outcome data from such programs. The program in Spain is a national program to determine both use and resistance patterns, whether inside or outside of the health care system. Their results have been recently published both in English and in Spanish and are leading to recommendations. The next step down the road is in Canada. The Consensus Conference held in May of last year resulted in a very clear and actionable plan throughout the country which was funded by the Health Ministry. Publication of this plan is now in progress. We have surveillance and process and in Scandinavia we have process and outcome with the results of a number of studies, for example, showing the impact on changes in use of erythromycin and other macrolides on the frequency of resistance in a number of gram-positive cocci. Thus, the templates are out there but I think we need to decide that this is an important enough problem that we're going to tackle it on a national basis. I don't see many signs that we are presently doing that in the United States.

Single user license provided by AAML. Further copying, networking, and distribution prohibited.

**Comment by Dr. Lederberg:** First of all, I thoroughly align myself with the movement

for the prudent use of antibiotics. I think we need to reflect on the implications of the prudent use of antibiotics. What we are basically saying is that for our accumulated stockpile and especially for the future, we want to limit the market and make it more specialized. We want to cut down the amount of antibiotics that are used in order to lengthen the period of time during which they are going to be used. One implication of this attitude is that it reduces the incentive for people to invest in the development of new antibiotics. In order to justify those developments they will have to be more costly. I personally think antibiotics are priceless when they are prudently used and applied in the appropriate circumstances. But, I think we have to look ahead and see that one of the ramifications of a prudent and rational antibiotic use system is an increase in the cost of these drugs.

**Comment by Dr. McGowan:** I agree with Dr. Lederberg. The good news for programs of this type is that the organisms don't care about the economics. As they evolve, I think they will provide opportunities that bring companies back into the area of antibiotic research. Those opportunities will lead to the new classes of drugs we need. I would argue that if lack of economic incentive decreased the research that is being done to bring yet another me-too drug to the market, hooray.

**Comment by Dr. Hughes, Centers for Disease Control and Prevention, U.S.A.:** It is interesting to see the number of questions regarding antimicrobial resistance and control. We know that a lot of antibiotics are used, particularly in the community, and in the United States for the treatment of upper respiratory tract infections, many of which don't require antibiotics. Over the years there have been many guidelines developed by several professional societies directed towards physicians to improve antibiotic use. I think a lot of people have recently come to feel that there is also a need for public education. We need to better educate the public about how valuable these antibiotics are and how important it is to conserve their usefulness. We also need to try to get the public to understand that there is a time and a place to use them, and that when they're indicated they need to be used as prescribed. The CDC has entered into a collaborative relationship with the American Academy of Pediatrics and the American Society for Microbiology to develop some educational materials targeted at the public. Clearly, though, this is a complicated issue and we need to bring all possible resources to bear on it.

**Question for Dr. Dumler, The Johns Hopkins University School of Medicine, U.S.A.:** Have there been cases of human granulocytic ehrlichiosis reported either from Europe or Asia, particularly in the northern part of Asia?

**Answer by Dr. Dumler:** To date there has been one case reported in the literature from Europe, a patient from Slovenia. I am aware of at least three additional actual clinical cases of human granulocytic ehrlichiosis that have also come from Slovenia, and there is considerable serologic evidence that infections are occurring at a much higher rate in Europe than was ever expected before. For instance, one of the things that we have used to assess how frequently infection occurs is to directly examine populations that are

exposed to the appropriate tick vector. In Europe, of course, that includes populations who currently have diagnoses of Lyme disease or Lyme Borreliosis. When we do that, patients in Switzerland, for instance, that have Lyme disease have an 18% seroprevalence of antibodies to the human granulocytic ehrlichia agent. The same data occur in the United Kingdom and perhaps slightly less in southern Germany. We have just recently finished a similar study documenting the presence of serologic reactions against human granulocytic ehrlichia in Eastern Europe and Bulgaria. I would expect that wherever we see Lyme Borreliosis and where *Ixodes* species ticks appear to be the predominant tick vector for this disease, we're likely to see ehrlichia infection of this particular class. That also completely excludes the other class of human ehrlichia that we have recently discussed, *Ehrlichia chaffeensis* infection. There is also serologic evidence of infection with that agent in various parts of Europe and in Africa as well. The answer with regard to Asia, therefore, is much more difficult because as far as I'm aware no one has looked at these agents or evidence of infection by these agents in Asia with the potential exception of some parts of Japan and Southeast Asia, particularly Malaysia, where there has been some evidence of infection with yet another species of ehrlichia. The first identified case of human ehrlichiosis caused by an organism then known as *Rickettsia sennetsu* was diagnosed in the 1950s in Japan. There is evidence that this disease is occurring in Southeast Asia although it's not very compelling evidence and apparently it's not a tick-borne disease in that area. I think the more we look, the more we will find that these infections are occurring. How severe they are is a question that's still wide open, as is the question of how often infections result in clinically apparent disease.

**Question for Dr. McGowan:** We have heard much about antibiotic resistance, but is there a correlation between the use of chemical disinfectants in hospitals and antibiotic resistance in bacteria?

**Answer by Dr. McGowan:** We don't know as much about that which is probably why it's not in the presentation. I do know that we can find a relationship between heavy metal ions and the occurrence of resistance in some organisms. I also know that the use of some topical compounds can certainly lead to the occurrence of resistance.

**Comment by Dr. Lederberg:** I'm not aware of any epidemiological information that would suggest a correlation. There is, however, at least one genetic factor that couples resistance to quaternary ammonium compounds, which are among the most common disinfectants, and resistance to other antibiotics, so it's at least a hypothetical possibility. There may be many other selective factors in the environment as well that simply have not been investigated.

**Comment by Dr. Martin Favero, Advanced Sterilization Products, U.S.A.:** I would like to comment on the question that dealt with the relationship of resistance to chemical germicides versus antibiotics because, in fact, there is quite a bit of information. It's true, as some of you have pointed out, that laboratory experiments have shown a connection between very low concentrations of things like quaternary ammonium compounds,

chlorhexidine, and some metallic ions to antibiotic resistant components in certain bacteria. A number of studies on this topic have been conducted by Dr. Rutala in the United States, A.D. Russell in the United Kingdom, and at the CDC. The results of these studies indicate that, if multidrug resistant tuberculosis organisms versus organisms that are not resistant or vancomycin-resistant enterococci versus those strains that are not resistant, are tested against common chemical germicides that are used in hospitals there is no difference in sensitivity. In fact, if these disinfectants are used at their recommended use-dilutions, the kill rates are so quick that one can't measure the difference between resistant and sensitive strains. If one dilutes out the germicide and then measures it and one gets a long loping survivor curve, one cannot detect any difference between the antibiotic resistant strains and the sensitive strains.

**Question for Dr. McGowan:** Could you please expand on your comment that our managed care system is playing a large role in the introduction of resistant organisms into a population where resistance was previously not present. One would have thought that the outpatient thrust would have had the opposite effect.

**Answer by Dr. McGowan:** I'm not sure I understand the last part of that but let me tell you why I think managed care is involved in the development of antibiotic resistance. There was a report in the *Journal of Clinical Microbiology* in 1996 regarding the simultaneous occurrence of MRSA infection (I think) in neonatal nurseries in two hospitals in the same city. These hospitals were reported to be widely separated but became part of the same health care system. To me, that means that when we do epidemiological studies we now need to introduce factors such as "Do the health care providers travel back and forth between sites?", as well as looking to see whether the patients travel back and forth between sites. The second reason I think that managed care is involved is the example of the study I gave you from a study which suggested that staffing levels may be important. My thought is that with managed care and its competitive edge, referral patterns change as a system seeks a new market. A new market means new patients coming from another segment of the population that this health care system was not seeing or, if you will, not previously capturing. That's why intuitively I think managed care may have an impact on the system.

**Question for Dr. McGowan:** It's a well established tradition in antibiotic therapy that when you begin a course, finish it. This may be weeks after cessation of symptoms. I could readily understand it for tuberculosis or other diseases where there is an anatomic sanctuary, diffusion-limiting problems, and so forth. I've been somewhat puzzled, however, about the universality of that recommendation and whether it has either a rational basis or an empirical justification, or both, and whether it's time to reconsider this practice since it is part of the overall antibiotic load being generated through the environment.

**Answer by Dr. McGowan:** I think this is a terrific question because it has a number of components that need to be examined. The first of these is whether someone who takes an antimicrobial for a short period of time is more likely to lead to the emergence of



resistance. We have some experimental evidence for that. The objective evidence in our textbooks and our teachings that justifies the duration of treatment is scanty for many infections, if it exists at all. I think that putting a great deal of attention into how long we need to treat patients and finding situations where the duration of treatment can be less than has been the oral tradition will be crucial to dealing with antimicrobials. Two examples for this are Group A streptococcal infection for which new technology, such as some of the newer macrolides currently in clinical trials, suggest that shorter duration can, in fact, be used. Secondly, our surgical colleagues have led the way in showing that shorter, rather than longer, courses of perioperative prophylaxis are not only just as good but often better.

**Question for Dr. McGowan:** You showed a picture of two cows in your talk and I am very surprised that this particular matter hasn't been given rather more prominence in your analysis of diffuse spreading of antibiotic usage throughout the environment of the country. Certainly gene resistance is likely to be found even in the material that is excreted by these herds. Would you like to comment on whether we should be trying harder to eliminate the use of antibiotics in animal husbandry.

**Answer by Dr. McGowan:** I tried to use the cartoon to illustrate the point that, if just half of the antimicrobial usage in this country is nonhuman use, it would be foolish for us not to factor that into the equation. I agree with you that it is an important factor and not only would I highlight agriculture, but also the increasingly important area economically in the function of aquaculture. The presentation by Dr. Levy and his colleagues at the Consensus Conference in Canada on the growth and importance of antimicrobial use in aquaculture was truly astounding to me.

**Question for Dr. Hughes:** In this morning's presentation, the importance of handwashing in the protection of patients was discussed. Contamination of meat products is directly related to poor cleaning or sanitization and poor protection against cross-contamination in processing facilities. How do we avoid having radiation processing of meat mask such poor practices and a backsliding of practices due to an attitude of 'radiation will take care of it'? How do we keep and bring additional pressure upon the root cause?

**Answer by Dr. Hughes:** I personally agree with what you're implying in the question. Even if food irradiation is adopted widely in this country, it is not the cure-all for prevention of food-borne disease. In my view it would add an additional margin of safety with food. One of the potential risks of totally relying upon radiation is that one might back away from other appropriate sanitary practices both on the farm and in the industry and, very importantly, in the kitchen.

**Comment by Dr. McGowan:** When I was a medical student, Dr. Carl Walter, a surgeon in Boston, emphasized that antibiotics will never make a second-class surgeon a first-class surgeon and that the use of antibiotics should not be taken as an excuse for poor aseptic technique. I think that we'll have to employ some of that same type of teaching if food irradiation isn't going to result in the same slippage.

**Question for Dr. Lederberg:** In an attempt to try to reduce the development of resistance to antibiotics in microorganisms, people have talked about the concepts of combined therapy and rotational use of antibiotics on the hospital formulary. I would like to hear your thoughts on the likelihood that these practices will buy us any time in reducing the development of resistance in the microorganisms we see in hospital infections.

**Answer by Dr. Lederberg:** From the very early days of bacterial genetics and the use of antibiotics, it seemed obvious to me and others that combined use of different antibiotics would greatly reduce the likelihood of the emergence of resistant organisms. If it takes two independent events and they're both rare, they wouldn't happen simultaneously, or one antibiotic would kill the mutants that are resistant to another one. I think that concept still has a lot of validity, but there is a 'but'. Now that we've seen the occurrence of multiple resistance cartridges, if you throw two antibiotics into the environment or at a bug that already has a multiresistance cartridge, this accelerates rather than reduces the development of that multiresistant strain. I think there are likely to be many circumstances where combined use of antibiotics would be extremely helpful in delaying or mitigating the development of resistance, but I think we have to look out for the multiresistance cartridges as a factor. I think that here there are traditions in the way that the FDA has operated and maybe there is some prudent basis for it that makes it extremely costly to evaluate the combination of two independent agents. I also believe there are likely to be many adjuvants where a single agent by itself might not be very potent or very effective, but where it could potentiate another drug. Augmentin is one example which has been successfully brought to practice.

There is an argument that rotation of antibiotic use should work. The argument says that if antibiotic resistance didn't carry with it some small fitness disadvantage, then everything would already be highly resistant. There's no free lunch so presumably one should predict that to incur resistance would also confer some reduction in growth rate or reduction of virulence. This reduction may not be a great deal, but may be enough that sensitive organisms can out-compete resistant ones. It's been very hard to get explicit evidence for this. While rotation might be expected to do some good, there isn't enough empirical basis to invite a strong support for this process. For example, if by rotation you reduce the incidence of resistant organisms from 80% to 20%, once the antibiotic is reintroduced, it won't be a very long before the proportion of resistant organisms rises.

I think the prudent use of antibiotics is the best recourse we have for dealing with the issue of antimicrobial resistance, along with providing all the necessary incentives to have an ongoing stream of new antibiotic agents.

**Question from the Floor:** When public health is effective, people generally don't notice it. Could a panel member comment on strategies necessary to ensure continuing governmental funding of public health measures, particularly research and especially in less well-resourced countries.

**Answer by Dr. Hughes:** I will comment on the United States perspective and perhaps Dr. Neira could provide the perspective of the WHO. I think your point is very well taken that

when public health is ultimately effective, nothing happens. What we have tried to do is highlight the important lessons of the Institute of Medicine Report on Emerging Infections and then tried to develop the CDC plan which I mentioned briefly in my talk this morning. In terms of increasing CDC funding for addressing emerging infections, this plan has been critically important. Having the IOM report and the CDC plan, and then having the microbes cooperate, if you will, has helped us gain an increase in resources. We actually try to work with the media to explain these issues — the problems, both as an outbreak is occurring and between episodes. I think the CDC is recognized as a policy maker in education. Public education is critically important and we will continue to work on it because we have made some progress.

**Answer by Dr. Neira:** Since last year we have been able to get the international community together to raise awareness about the problem of emerging and re-emerging infectious diseases and recently things are changing. The funds allocated to research may not be enough but we are taking all the opportunities we have to insist on improving international capacities and convincing developed countries that they are threatened by the risk of infectious diseases in their territory. Persons in other countries are threatened by the diseases that are occurring in Africa because we cannot place entire countries under quarantine and we cannot keep people from traveling. Concerning the media: they are working with us and we are using them to raise awareness. We must be very cautious, however, because the media are focused more and more on sensationalism. We must be very careful to avoid dramatic pictures and be as realistic as possible.

**Comment by Dr. Hughes:** As we have improved surveillance in the United States we have noticed things that we would have totally missed in previous years. Part of our policy maker/education approach is to try to convince individuals that, at least in the short term, when you try to put resources into these areas, in most cases, you will actually see an increase in the amount of disease that you recognize rather than a decrease.

**Question from the Floor:** What is the effect, or will some resistance in microorganisms develop, if food is irradiated, particularly at pasteurized or pasteurizing kinds of doses as opposed to sterilizing kinds of doses?

**Answer by Dr. Marshall Cleland, Atomic Energy of Canada:** This question was posed early in the research on food irradiation and was investigated by several laboratories, notably the U.S. Army Food Engineering Laboratory in Massachusetts did much of the work on the irradiation of meat. These laboratories found that after giving successive generations sublethal doses, they did not develop an increased resistance to radiation. As a matter of fact, the surviving organisms seemed to get less and less viable. There seemed to be an accumulation of genetic damage that weakened the species. There doesn't seem to be much risk of that.

**Question for Dr. Lederberg:** Given our burgeoning population, cumulative treatment, or lack of treatment of waste, co-circulation of numerous infections, and simultaneous infections (viruses and bacteria at the same time), would you care to comment on the

potential of co-infection that actually leads to the genesis of emerging diseases. For example, what is the potential for one microbe to potentiate another organism, perhaps crossing a species barrier that it doesn't normally cross.

**Comment by Dr. Lederberg:** There is a substantial history of synergism of a variety of infectious agents. Perhaps, historically, there have been some examples where they played a very large role. I would be inclined to think that under modern conditions that to have not one but two organisms chase one another to find the range of habitats would be rather less likely. I think that it is more likely that there will be new pandemics of single agents and some of these will be compounded by opportunistic infections that ride on the heels of the primary one.

**Comment by Dr. Dumler:** I would like to add one comment to that with regard to tick-borne infections. There's actually a precedent out there with regard to Lyme disease which is that patients who live in Lyme disease endemic areas are often predisposed to become infected with a protozoan organism called *Babesia microti*. *Babesia microti* actually causes a relatively severe disease under certain circumstances. Under other circumstances, however, it can lead to at least mild immune suppression which can then worsen the symptoms of Lyme disease so that the possibility exists that two consecutive simultaneous infections can then result in higher virulence than a second pathogen. This is one example of where interaction between organisms can occur and lead to a worse outcome than each individual infection. Whether or not these kinds of conditions will exist for other pathogens that we classically recognize, I don't think that anyone has done a lot of work on that at this point.

Another example of where the simultaneous exposure to infectious agents can potentially become more cumulative than otherwise would normally occur concerns hemorrhagic fever. One of the hypotheses for certain diseases is that the actual effect of the hemorrhagic fever will lead to hypersensitivity to small doses of exopolysaccharide from gram-negative pathogens. This hypersensitivity can then predispose the individual to more severe hemorrhagic fever than would otherwise occur.

**Comment by Dr. Hughes:** I think that this question really emphasizes the need for heightened infectious disease surveillance and the fact that we need a number of successive agents to continue to be prepared for the unexpected in the future.

**Final Comments by Dr. Lederberg:** I would like to express my own appreciation for my colleagues for whom I have learned a great deal. It's been a privilege to sit at their feet. Their experience in a wide variety of different specialty areas has been extremely illuminating of the natural history and human pathos of what is involved in a variety of infectious circumstances. There can be no doubt whatever that we still face very formidable problems in coping with microbial competition.



# Session II

## The Biology and Inactivation of Prions

**Chairman: Stanley B. Prusiner, M.D.**  
*University of California, San Francisco, U.S.A.*



# **The Prion Diseases of Animals and Humans**

**Stanley B. Prusiner, M.D.**

*University of California, San Francisco, U.S.A.*



# Introduction

Sporadic Creutzfeldt-Jakob disease (CJD) accounts for ~85% of all cases of human prion disease, while inherited prion diseases account for 10 to 15% of all cases (Table 1). The infectious prion diseases represent a small minority and account for less than 1% of all cases. Although the transmissibility of prions is an important biologic feature, infection does not seem to play an important role in the natural history of the disease in most cases. Familial CJD, Gerstmann-Sträussler-Scheinker disease (GSS), and fatal familial insomnia (FFI) are all dominantly-inherited prion diseases which have been shown to be caused by mutations in the PrP gene [122,143,199,343,346]. Kuru of the New Guinea Fore people is thought to have resulted from the consumption of brains from dying relatives during ritualistic cannibalism [7,145]. Iatrogenic CJD (iCJD) is thought to result from the accidental inoculation of patients with prions [134,160].

Six diseases of animals are caused by prions (Table 1). Scrapie of sheep and goats is the prototypic prion disease. Mink encephalopathy, chronic wasting disease, bovine spongiform encephalopathy, feline spongiform encephalopathy, and exotic ungulate encephalopathy are all thought to occur after the consumption of prion-infected foodstuffs.

For many decades, scrapie was considered an enigmatic disorder of sheep and goats, the etiology of which was unknown. By 1938, experimental transfer of scrapie from one sheep to goats began to argue for an infectious etiology [106]. Meanwhile, observations that the genetic backgrounds of flocks profoundly influence their susceptibility to scrapie raised the possibility that scrapie might be a heritable disorder [178]. These opposing views sparked many controversial encounters [121,335] and foreshadowed a series of equally bitter arguments about the possible structure of the transmissible scrapie agent [338].

Although the notion of prions was initially met with considerable skepticism, the steady accumulation of experimental data over the past 10 years has created a rather convincing edifice which argues that prions are unique among all infectious pathogens [348,350-352,366]. While the human prion diseases once presented a rather confusing picture, the finding that prion diseases may be both inherited and transmissible brought considerable clarity. The situation with the natural prion diseases of animals remains more problematic. Progress in understanding the human prion diseases has its roots in reports of familial cases [302,405], transmission to animals [147,159], discovery of the prion protein [39,353], and molecular cloning of the PrP gene [89,325,359].

Prions are composed largely, if not entirely, of an abnormal isoform of cellular PrP designated PrP<sup>Sc</sup> [142,350]. Although PrP<sup>Sc</sup> is formed from cellular PrP (PrP<sup>C</sup>) by a posttranslational process [42,43,80] in which PrP<sup>Sc</sup> acquires a high  $\beta$ -sheet content [332], several lines of evidence argue that PrP<sup>Sc</sup> formation occurs in caveolae-like domains near the surface of the cell. It seems likely that a protein provisionally designated protein X facilitates the conversion of PrP<sup>C</sup> into PrP<sup>Sc</sup>.

While genetic ablation of the PrP gene caused disease in two lines of PrP-deficient (Prnp<sup>0/0</sup>) mice at about 18 months of age, two other lines remained healthy [67,277,384]. The Prnp<sup>0/0</sup> mice were resistant to scrapie and did not replicate prions [66,278,358,385].

Restoring PrP expression by genetic crosses rendered the mice susceptible to prions and made them permissive for prion replication. The susceptible mice developed disease with incubation times of less than 3 months. These findings are in accord with the inherited human prion diseases which are autosomal dominant disorders where mutant PrP<sup>C</sup> is converted into mutant PrP<sup>Sc</sup> and the accumulation of PrP<sup>Sc</sup> produces central nervous system (CNS) dysfunction [144]. Thus there is no evidence that a deficiency of PrP<sup>C</sup> is responsible for malfunction of the brain in any of the prion diseases.

**Table 1. The Prion Diseases**

Disease	Host	Mechanism of Pathogenesis
<b>A. Kuru</b>	Fore people	Infection through ritualistic cannibalism
iCJD	Humans	Infection from prion-contaminated HGH, dura mater grafts, etc.
vCJD	Humans	Infection from bovine prions?
fCJD	Humans	Germline mutations in PrP gene
GSS	Humans	Germline mutations in PrP gene
FFI	Humans	Germline mutation in PrP gene (D178N, M129)
sCJD	Humans	Somatic mutation or spontaneous conversion of PrP <sup>C</sup> into PrP <sup>Sc</sup> ?
FSI	Humans	Somatic mutation or spontaneous conversion of PrP <sup>C</sup> into PrP <sup>Sc</sup> ?
<b>B. Scrapie</b>	Sheep	Infection in genetically susceptible sheep
BSE	Cattle	Infection with prion-contaminated MBM
TME	Mink	Infection with prions from sheep or cattle
CWD	Mule deer, elk	Unknown
FSE	Cats	Infection with prion-contaminated beef
Exotic ungulate encephalopathy	Greater kudu, nyala, oryx	Infection with prion-contaminated MBM

**Key:** BSE, bovine spongiform encephalopathy; CJD, Creutzfeldt-Jakob disease; sCJD, sporadic CJD; fCJD, familial CJD; iCJD, iatrogenic CJD; vCJD, (new) variant CJD; CWD, chronic wasting disease; FFI, fatal familial insomnia; FSE, feline spongiform encephalopathy; FSI, fatal sporadic insomnia; GSS, Gerstmann-Sträussler-Scheinker disease; HGH, human growth hormone; MBM, meat and bone meal; TME, transmissible mink encephalopathy.

# Sporadic, Genetic, and Infectious Prion Diseases

The four human prion diseases often referred to as kuru, CJD, GSS, and FFI are variants of the same disorder and thus share many features. The human prion diseases are manifested as sporadic, genetic, and infectious disorders of the CNS. All three forms of the human prion diseases have been transmitted to experimental animals [147,159,287,430-432]. Kuru is thought to have been spread exclusively through the infectious mechanism by ritualistic cannibalism [7,145].

While a few CJD cases can be traced to inoculation with prions, i.e., human growth hormone (HGH), cornea transplantation, and cerebral electrode implantation, most are sporadic despite considerable efforts to implicate scrapie-infected sheep as an exogenous source of prions [46,102,186]. Although sCJD could be explained by prions being ubiquitous in our food chain with their efficiency of infection being very low, there is no evidence to support this hypothesis. Of note, infection by the oral route is  $10^9$  times less efficient than intracerebral inoculation in hamsters [354]. Whether or not sCJD can arise endogenously without any exogenous prion source remains to be established, but somatic mutation of the PrP gene or the infrequent spontaneous conversion of PrP<sup>C</sup> into PrP<sup>Sc</sup> seem to be likely explanations for sCJD [349,350].

About 10 to 15% of CJD and virtually all cases of GSS are inherited. Familial CJD (fCJD) and GSS as well as FFI are caused by germline mutations in the PrP gene. Five mutations of the PrP gene have been genetically linked to the development of the human prion diseases. Although some investigators argue that PrP<sup>C</sup> is a receptor for the putative scrapie 'virus' and mutations in PrP<sup>C</sup> render people more susceptible to this ubiquitous 'virus', considerable evidence argues against such a hypothesis.

# Terminology

The term prion is used to denote the small proteinaceous infectious particles that lack nucleic acid (Table 2). Prions cause scrapie and other related transmissible neurodegenerative diseases of animals and humans (Table 1). Prions are composed largely, if not entirely, of a protein designated as the scrapie isoform of the prion protein designated PrP<sup>Sc</sup>. A posttranslational conformational change generates PrP<sup>Sc</sup> from the normal, cellular isoform of the prion protein denoted PrP<sup>C</sup>. A major feature that distinguishes prions from viruses is the finding that both PrP isoforms are encoded by a chromosomal gene. In humans, the PrP gene is designated PRNP and is located on the short arm of chromosome 20. In mice, the PrP gene is designated Prnp and is located on chromosome 2. PrP<sup>Sc</sup> is readily distinguished from PrP<sup>C</sup> by its different biochemical and biophysical properties. Limited proteolysis of PrP<sup>Sc</sup> produces a smaller protease-resistant molecule of ~142 amino acids designated PrP 27-30; under the same conditions PrP<sup>C</sup> is completely hydrolyzed. In the presence of detergent, PrP 27-30 polymerizes into amyloid rods. These prion amyloid rods, formed by limited proteolysis and detergent extraction, are indistinguishable from the filaments that aggregate to form PrP amyloid plaques in the CNS. Both the rods and the PrP amyloid filaments found in brain tissue exhibit similar ultrastructural morphology and green-gold birefringence after staining with Congo red dye [364]. To differentiate the amyloid plaques found in the prion diseases from those found in aged brains, Alzheimer's disease, and Down's syndrome, it has been suggested that the former be labeled PrP plaques and the latter be called A $\beta$  plaques [376].

**Table 2. Glossary of Prion Terminology**

Prion	Proteinaceous infectious particle that lacks nucleic acid. Prions are composed largely, if not entirely, of PrP <sup>Sc</sup> molecules. They can cause scrapie in animals and related neurodegenerative diseases of humans such as CJD. "Scrapie agent" is a synonym.
PrP <sup>Sc</sup>	Scrapie isoform of the prion protein. This protein is the only identifiable macromolecule in purified preparations of scrapie prions.
PrP <sup>C</sup>	Cellular isoform of the prion protein.
PrP 27-30	Digestion of PrP <sup>Sc</sup> with proteinase K generates PrP 27-30 by truncation of the N-terminus.
PRNP	PrP gene located on human chromosome 20.
<i>Prnp</i>	PrP gene located on mouse chromosome 2. <i>Prnp</i> is congruent with the <i>Sinc</i> and <i>Prn-i</i> genes that control scrapie incubation times in mice.
<i>Pid-1</i>	A locus on mouse chromosome 17 that appears to influence experimental CJD and scrapie incubation times.
Prion rod	An aggregate of prions composed largely of PrP 27-30 molecules. Created by detergent extraction and limited proteolysis of PrP <sup>Sc</sup> . Morphologically and histochemically indistinguishable from many amyloids.

PrP Amyloid containing PrP in the brain of animals or humans with prion disease; often amyloid accumulates as plaques.

---

The term scrapie-associated fibrils (SAF) continues to be used by some investigators as a synonym for the prion rods even though the ultrastructure of these polymers was used to differentiate them from amyloids [303-305].

Four diseases of humans are caused by prions or mutations in the PrP gene (Table 1). While kuru is confined to the mountainous Fore region of Papua New Guinea, the other three diseases are found worldwide. Distinguishing between these three disorders has grown increasingly difficult with the recognition that fCJD, GSS, and FFI are autosomal dominant diseases that are caused by mutations in the PRNP gene. Initially, we thought that a specific PrP mutation was very frequently associated with a particular clinical and neuropathological presentation [202]. While that is often the case, an increasing number of exceptions are beginning to accumulate. In a single family with a particular PrP mutation, different clinical and neuropathologic manifestations of the same genetic disease can be seen [199]. These different constellations of CNS symptoms, signs, and neuropathological lesions would seem to render the old system of classification obsolete since the precise chemical cause is now known. Instead, it has been suggested that these disorders be labeled prion diseases followed by the mutation. For example, many patients with a PrP mutation at codon 117 present with a dementing disorder, in which numerous PrP amyloid plaques characteristic of GSS are found [124,203]; however, other patients with the same mutation present primarily with ataxia [292].

Although the above proposal for a new terminology may eventually prove preferable because it is based on the molecular lesion, some clinicians currently prefer the old terminology where CJD usually connotes a dementing illness and GSS an ataxic disorder in which numerous PrP amyloid plaques are found at autopsy. In the interest of clarity, much of the older terminology is retained in this manuscript.

# Measurement of Prion Infectivity

The experimental transmission of scrapie from sheep [177] to mice [84] gave investigators a more convenient laboratory model, which yielded considerable information on the nature of the unusual infectious pathogen that causes scrapie [2-4,155,182,308,339]. Yet progress was slow because quantification of infectivity in a single sample required holding 60 mice for one year before accurate scoring could be accomplished [84].

The availability of a more rapid and economical bioassay for the scrapie agent in Syrian golden hamsters accelerated purification of the infectious particles [355,360].

Bioassays for transmission of the human prion diseases to experimental animals was initially confined to apes and monkeys [53]. The incubation periods were quite prolonged, which made experimental studies difficult. Subsequently, CJD and GSS were transmitted to laboratory rodents with only a few animals developing disease after prolonged incubation times of 500 days or more on primary passage [184,280,417,420]. Fewer cases have been transmitted to goats, marmosets, cats, and laboratory rodents. On second passage the incubation time was reduced when homologous prions were inoculated. Before the molecular mechanisms responsible for prion replication were elucidated, most investigators assumed that prions that had originated in humans but were subsequently passaged in mice were different from those that had originated in sheep and were then passaged in mice. We now understand that regardless of the origin, prions passaged in mice become mouse prions on primary passage [351,352,366]. Having stated that prions passaged in mice become mouse prions on the first passage, it is noteworthy that the original strain of prions may persist or be changed when prions are passaged from one species to another.

Transgenic (Tg) mice have revolutionized the study of prion diseases. Mice expressing human (Hu) or chimeric Hu/mouse (Mo) PrP transgenes provide a much more rapid and economical means of studying Hu prions and permit the preservation of the strain of prions found in the Hu specimen [430-432]. Similarly, mice expressing bovine (Bov) PrP transgenes allow the study of BSE prions [391].

# Prion Diseases of Animals

## *Scrapie of Sheep and Goats*

Although scrapie was recognized as a distinct disorder of sheep with respect to its clinical manifestations as early as 1738, the disease remained enigmatic even with respect to its pathology for more than two centuries. Some veterinarians thought that scrapie was a disease of muscle caused by parasites while others thought that it was a dystrophic process. An investigation into the etiology of scrapie followed the vaccination of sheep for looping ill virus with formalin-treated extracts of ovine lymphoid tissue unknowingly contaminated with scrapie prions [177]. Two years later, more than 1500 sheep developed scrapie from this vaccine.

Even after the transmissibility of scrapie became well established, the spread of scrapie within and among flocks of sheep remained puzzling. Parry argued that host genes were responsible for the development of scrapie in sheep. He was convinced that natural scrapie is a genetic disease which could be eradicated by proper breeding protocols [335,336]. He considered its transmission by inoculation of importance primarily for laboratory studies and communicable infection of little consequence in nature. Other investigators viewed natural scrapie as an infectious disease and argued that host genetics only modulate susceptibility to an endemic infectious agent [121]. The incubation time gene for experimental scrapie in Cheviot sheep called *Sip* is said to be linked to a PrP gene restriction fragment length polymorphism [213], a situation perhaps analogous to the locus initially called *Sinc* in mice.

### ***PrP Gene Polymorphisms and Scrapie***

In sheep, polymorphisms at codons 136, 154, and 171 of the PrP gene have been studied with respect to the occurrence of scrapie (Figure 1) [94,172,173,263]. Studies of natural scrapie in the United States have shown that ~85% of the afflicted sheep are of the Suffolk breed. Only those Suffolk sheep homozygous for Gln (Q) at codon 171 were found with scrapie, although healthy controls with QQ, QR, and RR genotypes were also found [211,217,219,323,446]. These results argue that susceptibility in Suffolk sheep is governed by the PrP codon 171 polymorphism. Indeed, sheep encoding the R/R polymorphism at position 171 seem to be resistant to scrapie [22,94,175,211,214,217,219,322,446]; presumably, this was the genetic basis of Parry's scrapie eradication program in Great Britain 30 years ago [335,336]. In Cheviot sheep, the PrP codon 171 polymorphism has a profound influence on susceptibility to scrapie as in Suffolk, but codon 136 also seems to modulate susceptibility [171,212].

Since sheep heterozygous for R171 appear equally resistant as homozygotes, the substitution of this basic residue appears to act as a dominant negative. Studies on the mapping of the site of interaction of PrP<sup>C</sup> with protein X provide an explanation for this phenomenon [234]. Substitution of an R in PrP<sup>C</sup> at the site where protein X binds abolished PrP<sup>Sc</sup> formation. Those studies suggested that the mutated PrP<sup>C</sup> binds to protein X but is not released and thus, acts as a dominant negative.

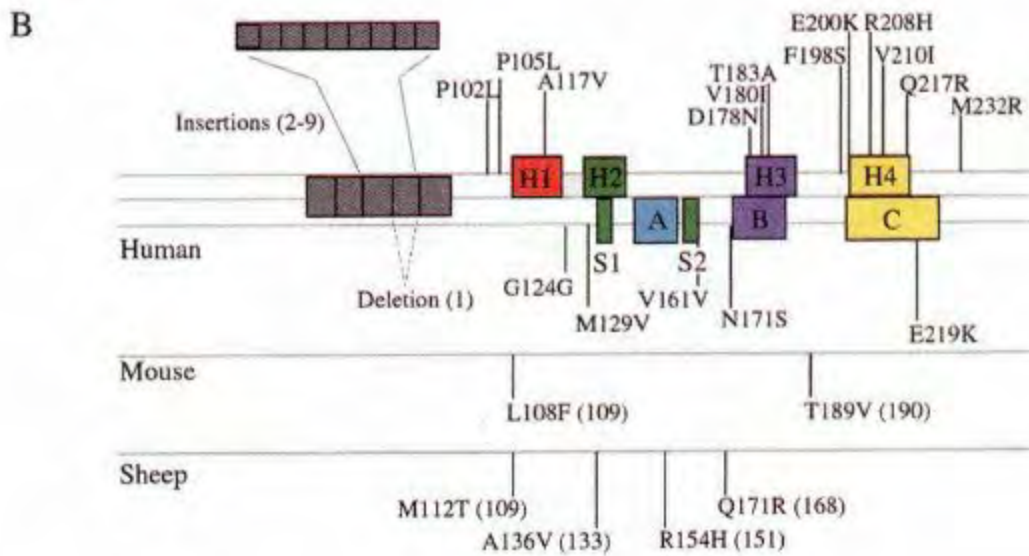
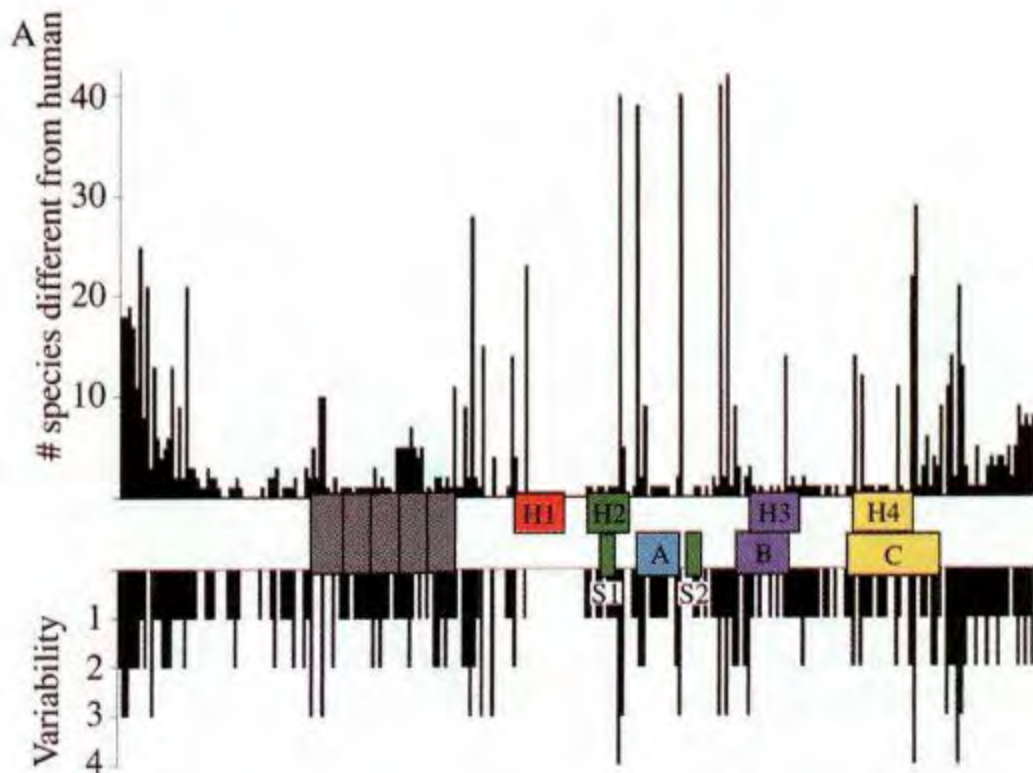

**Figure 1.** Mutations of the prion protein gene.

Mutations causing inherited human prion disease and polymorphisms in human, mouse, and sheep. Above the line of the human sequence are mutations that cause prion disease. Below the lines are polymorphisms, some but not all of which are known to influence the onset as well as the phenotype of disease. Data were compiled by Paul Bamborough and Fred E. Cohen.

### *Bovine Spongiform Encephalopathy*

Prion strains and the species barrier are of paramount importance in understanding the



BSE epidemic in Great Britain, in which it is estimated that almost one million cattle were infected with prions [10,316]. The mean incubation time for BSE is about 5 years. Most cattle therefore did not manifest disease since they were slaughtered between 2 and 3 years of age [404]. Nevertheless, more than 170,000 cattle, primarily dairy cows, have died of BSE over the past decade (Figure 2A) [10]. BSE is a massive common source epidemic caused by meat and bone meal (MBM) fed primarily to dairy cows [316,449]. The MBM was prepared from the offal of sheep, cattle, pigs, and chickens as a high protein nutritional supplement. In the late 1970s, the hydrocarbon-solvent extraction method used in the rendering of offal began to be abandoned, which resulted in MBM with a much higher fat content [449]. It is now thought that this change in the rendering process allowed scrapie prions from sheep to survive rendering and to be passed into cattle. Alternatively, bovine prions were present at low levels prior to modification of the rendering process and with the processing change survived in sufficient numbers to initiate the BSE epidemic when inoculated back into cattle orally through MBM. Against the latter hypothesis is the widespread geographical distribution throughout England of the initial 17 cases of BSE, which occurred almost simultaneously [241,316,448]. Furthermore, there is no evidence of a preexisting prion disease of cattle, either in Great Britain or elsewhere.

### ***Origin of BSE Prions?***

The origin of the bovine prions causing BSE cannot be determined by examining the amino acid sequence of PrP<sup>Sc</sup> in cattle with BSE since the PrP<sup>Sc</sup> in these animals has the bovine sequence whether the initial prions in MBM came from cattle or sheep. The bovine PrP sequence differs from that of sheep at seven or eight positions [173,174,356]. In contrast to the many PrP polymorphisms found in sheep, only one PrP polymorphism has been found in cattle. Though most bovine PrP alleles encode five octarepeats, some encode six. PrP alleles encoding six octarepeats do not seem to be over-represented in BSE (Figure 1) [215].

Brain extracts from BSE cattle caused disease in cattle, sheep, mice, pigs, and mink after intracerebral inoculation [59,64,108,109,138], but prions in brain extracts from sheep with scrapie fed to cattle produced illness substantially different from BSE [378]. No exhaustive effort has been made, however, to test different strains of sheep prions or to examine the disease following bovine to bovine passage. The annual incidence of sheep with scrapie in Britain over the past two decades has remained relatively low [J. Wilesmith, unpublished data]. In July 1988, the practice of feeding MBM to sheep and cattle was banned. Recent statistics argue that the epidemic is now disappearing as a result of this ruminant feed ban (Figure 2A) [10], reminiscent of the disappearance of kuru in the Fore people of New Guinea (Figure 2B) [6,145].

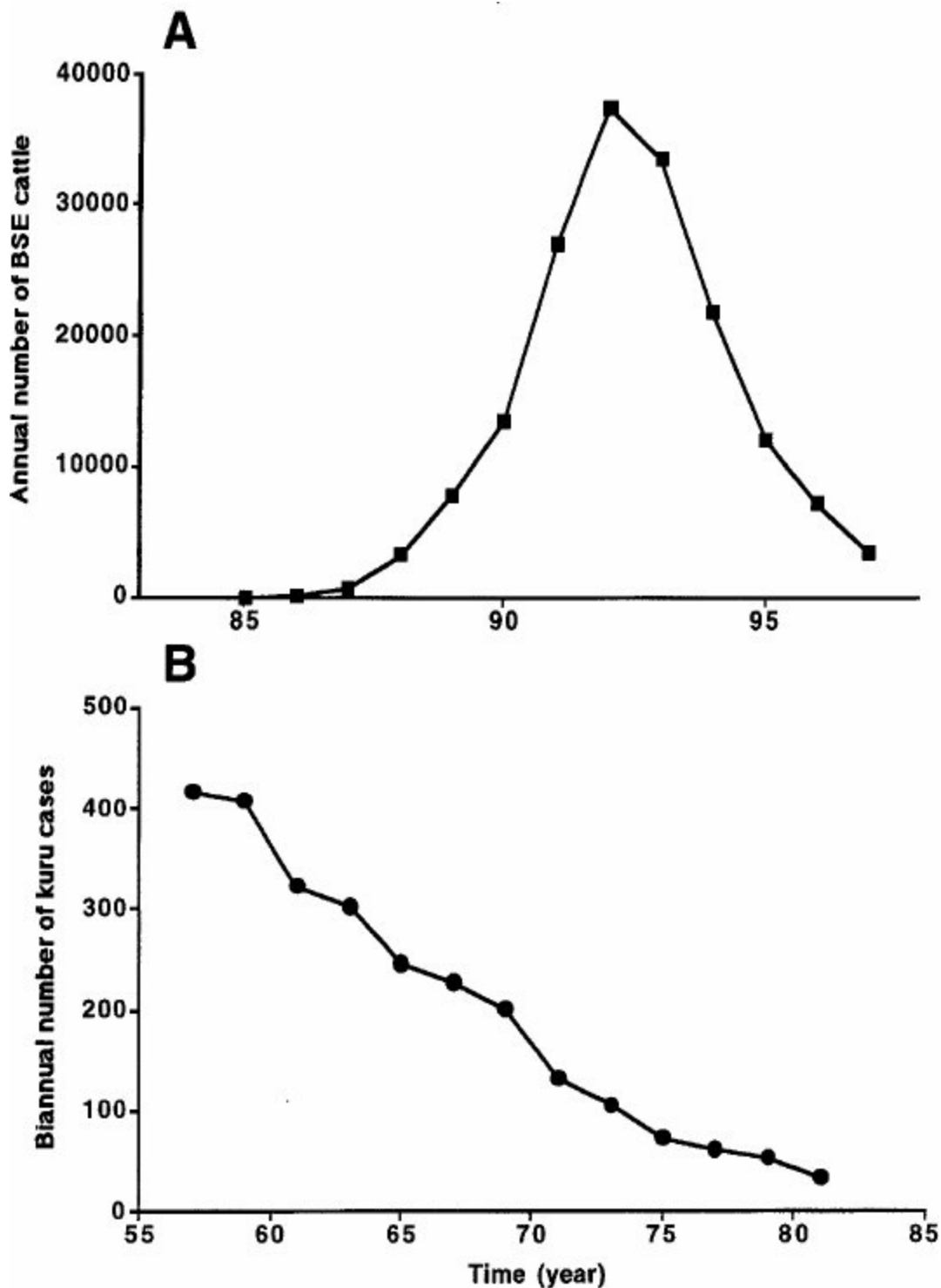

**Figure 2.** Disappearance of the kuru and BSE epidemics.  
**(A)** Number of annual cases of BSE in cattle in Great Britain.  
**(B)** Number of biannual cases of kuru in Papua New Guinea. Data compiled for BSE by John Wilesmith and for kuru by Michael Alpers.

**Monitoring Cattle for BSE Prions**

Although many plans have been offered for the culling of older cattle in order to minimize the spread of BSE [10], it seems more important to monitor the frequency of prion disease in cattle as they are slaughtered for human consumption. No reliable, specific test for prion

disease in live animals is available, but immunoassays for PrP<sup>Sc</sup> in the brainstems of cattle might provide a reasonable approach to establishing the incidence of subclinical BSE in cattle entering the human food chain [181,196,254,356,394,410]. Determining how early in the incubation period PrP<sup>Sc</sup> can be detected by immunological methods is now possible since a reliable bioassay has been created by expressing the BoPrP gene in Tg mice [391]. Prior to development of Tg(BoPrP)Prnp<sup>0/0</sup> mice, non-Tg mice inoculated intracerebrally with BSE brain extracts required more than 300 days to develop disease [64,135,266,428]. Depending on the titer of the inoculum, the structures of PrP<sup>C</sup> and PrP<sup>Sc</sup>, and the structure of protein X, the number of inoculated animals developing disease can vary over a wide range. Some investigators have stated that transmission of BSE to mice is quite variable with incubation periods exceeding one year [266] while others report low prion titers in BSE brain homogenates [135,428] compared to rodent brain scrapie [130,210,238,355].

# Sporadic Creutzfeldt-Jakob Disease

The recognition that the neuropathology of a cerebellar disorder of New Guinea natives was similar to that of scrapie prompted Hadlow to suggest that transmission studies in apes be performed with extracts of brain tissue from patients dying of kuru [183]. The success of those studies [147] was followed by the transmission of CJD to apes [159] based on the earlier recognition that the neuropathological changes in kuru were similar to those found in CJD [248]. In 1920, Creutzfeldt reported the case of a 23-year-old woman who died of a neurologic disease [104] and the following year Jakob reported five cases [222-224]. Ironically, some investigators doubt that Creutzfeldt described the disease that now bears his name [371,372].

Infectious, sporadic, and inherited forms of CJD are now recognized. The only documented cases of the infectious form of CJD are iatrogenic. The great majority of CJD cases are sporadic while 10 to 15% of cases are familial and inherited as an autosomal dominant trait with variable penetrance [41,286-288,302,317,379,382,405].

## *Epidemiology of CJD*

CJD is found throughout the world. The incidence of sporadic CJD is approximately one case per million population [290]. Although many geographical clusters of CJD have been reported [162,276,290,297], each has been shown to segregate with a PRNP gene mutation which results in a nonconservative substitution. To date, attempts to identify a common exposure to some etiologic agent have been unsuccessful both for the sporadic and familial cases [48,102,452]. Some families have multiple cases of both CJD and Alzheimer's disease [286]. The relationship, if any, between CJD and Alzheimer's disease remains to be established [359].

Ingestion of scrapie-infected sheep or goat meat as a cause of CJD in humans has not been shown by epidemiologic studies although speculation about this potential route of inoculation continues [8,36,46,272,290,380]. On the other hand, it is assumed that the transmission of kuru among New Guinea tribesmen occurred after the consumption of kuru-infected brain during ritualistic cannibalism [6,7,145]. Studies with Syrian hamsters provided convincing evidence that the oral route of inoculation, although extremely inefficient, can with regularity be a source of prion infection [354].

## *General Clinical Features*

Nonspecific prodromal symptoms occur in about a third of CJD patients and may include fatigue, sleep disturbance, weight loss, headache, general malaise, and ill-defined pain [77]. The majority of CJD patients present with deficits in higher cortical function [49,77,245,267,296,311,379,397,452]. These deficits virtually always progress to a state of profound dementia characterized by memory loss, impaired judgment, and a decline in virtually all aspects of intellectual function [318]. A minority of patients present with either visual impairment or cerebellar gait and coordination deficits. Frequently, the cerebellar deficits are rapidly followed by progressive dementia [58,176]. Visual problems often begin

with blurred vision and diminished acuity, rapidly followed by dementia. Patients with CJD are generally between 50 and 75 years of age; however, patients as young as 17 and as old as 83 have been recorded [49,77,194,195,289,452].

Other signs and symptoms include extrapyramidal dysfunction manifested as rigidity, mask-like facies, or choreoathetoid movements; pyramidal signs (usually mild); seizures (usually major motor); and, less commonly, hyperesthesia; supranuclear gaze palsy; optic atrophy; and vegetative signs such as changes in weight, temperature, sweating, or menstruation [24,77]. One study indicates that lower motor neuron disease in association with a progressive dementing syndrome is not transmissible to apes and monkeys [386]. Based on these findings, the authors argue that the term “amyotrophic Creutzfeldt-Jakob disease” is not a useful label.

### *Myoclonus in CJD*

Most patients (~90%) with CJD exhibit myoclonus appearing at various times throughout the illness [77,379,452]. Unlike other involuntary movements, myoclonus persists during sleep. Startle myoclonus elicited by loud sounds or bright lights is frequent. It is important to stress that myoclonus is neither specific nor confined to CJD. Dementia with myoclonus can also be due to Alzheimer’s disease [441] as well as cryptococcal encephalitis [403] or Unverricht-Lundborg disease, etc.

### *Electroencephalography in CJD*

The electroencephalogram (EEG) is often useful in the diagnosis of CJD. During the early phase of CJD, the EEG is usually normal or shows only scattered theta activity. In most advanced cases, repetitive, high voltage, tri- and polyphasic sharp discharges are seen. The presence of these stereotyped periodic bursts of <200 msec duration occurring every 1-2 sec make the diagnosis of CJD very likely [12,69,90,258,268,318,437]. These discharges are frequently but not always symmetrical; there may be a one-sided predominance in amplitude. As CJD progresses, normal background rhythms become fragmentary and slower. The appearance of these periodic electrical complexes during the clinical course of CJD is variable and in many cases their presence is transient.

### *Clinical Course*

In documented cases of accidental transmission of CJD to human subjects, an incubation period of 1.5 to 2.0 years preceded the development of clinical disease [25,127]. In other cases, incubation periods of up to 30 years have been suggested. Most patients with CJD live 6 to 12 months after the onset of clinical signs and symptoms [77,289,452], while some live for up to 5 years [55].

### *Clinical Diagnosis of CJD*

The constellation of dementia, myoclonus, and periodic electrical bursts in an afebrile 60-year-old patient is generally CJD. Clinical abnormalities in CJD are confined to the CNS.

Fever, elevated sedimentation rate, leukocytosis in blood, or a pleocytosis in cerebrospinal fluid (CSF) should alert the physician to another etiology to explain the patient's CNS dysfunction.

### *Differential Diagnosis*

Many conditions may superficially mimic CJD. Alzheimer's disease is occasionally accompanied by myoclonus [441], but is usually distinguished by its protracted course and lack of motor and visual dysfunction.

Intracranial vasculitides may produce nearly all of the symptoms and signs associated with CJD, sometimes without systemic abnormalities. Myoclonus is exceptional with cerebral vasculitis, but focal seizures may confuse the picture; furthermore, myoclonus is often absent in the early stages of CJD. Stepwise change in deficits, prominent headache, abnormal cerebrospinal fluid, and focal tomographic or angiographic abnormalities all favor vasculitis.

Neurosyphilis may present with dementia and myoclonus relatively rapidly [76] but is easily distinguished from CJD by CSF findings as is cryptococcal meningoencephalitis [403]. A diffuse intracranial tumor may occasionally be confused with CJD. In rare cases of CNS neoplasia in which the CT is normal and there are no signs of increased intracranial pressure, CSF protein is usually elevated. Kuf's disease and myoclonic epilepsy with Lafora bodies may be responsible for dementia, myoclonus, and ataxia, but the less acute courses and prominent seizures distinguish them from CJD [13].

A number of diseases that may simulate CJD are easily discriminated by noting the clinical setting in which they occur. These include anoxic encephalopathy, subacute sclerosing panencephalitis, progressive rubella panencephalitis, herpes simplex encephalitis (in immunoincompetent hosts), dialysis dementia, uremia, and portalsystemic shunt encephalopathy [76,270,368].

When CJD begins atypically, it may for a short time resemble other disorders such as Parkinson's disease, progressive supranuclear palsy, or progressive multifocal leukoencephalopathy. However, this resemblance usually fades early in the course of CJD [28,77].

The AIDS dementia complex may occasionally imitate CJD in onset, early course, physical signs, CT findings, and lack of abnormalities on routine CSF studies [270,400]. The few such patients without manifestations of systemic immunodeficiency (<10%) should have inquiries into risk factors, and should have serum antibodies to HIV determined. Additionally, more specific CSF tests are likely to be abnormal — in one study, CSF oligoclonal bands were present in six of nine patients, and intra-blood-brain barrier synthesis of IgG specific for HIV was elevated in eight of nine patients [370].

### *Ancillary Tests*

With the exception of brain biopsy, there are no specific tests for CJD. EEG is the most helpful. CT may be normal or show cortical atrophy; to date, magnetic resonance imaging studies have not been more helpful [24]. Positron emission tomography shows a loss of

normal metabolic landmarks, which is felt by some to be of differential significance [24] but by others to be indistinguishable from the pattern produced by Alzheimer's disease [139]. CSF is nearly always normal, but may show a minimal protein elevation [77]. Two-dimensional gel electrophoresis of CSF proteins from CJD patients found a protein, 14-3-3, which was elevated in most CJD patients. However, similar elevations of 14-3-3 levels in the CSF of patients with herpes simplex virus encephalitis, multi-infarct dementia, and stroke have been found [187,206,381,459]. In Alzheimer's disease, 14-3-3 is generally not elevated. In the serum of some patients with CJD, the S-100 protein is elevated but like 14-3-3, this elevation is not specific [459]. The lack of specificity found with this test argues that these proteins are released into the CSF as a result of injury to the CNS.

### *Brain Biopsy*

If the constellation of pathologic changes frequently found in CJD is seen in a brain biopsy, then the diagnosis is reasonably secure. However, enthusiasm for brain biopsies in patients with suspected CJD is quite low for two reasons: first, there is no specific effective treatment for CJD, and second, decontamination of surgical instruments requires special protocols as described below.

### *Transmission to Animals*

CJD has been transmitted to a variety of laboratory animals. Over 300 cases of human prion disease have been transmitted to apes and monkeys [53]. Fewer cases have been transmitted to goats, marmosets, cats, and laboratory rodents [158,184,280,417]. Typically, only a minority of these nonprimates develop prion disease after inoculation with human brain extracts from patients who died of prion disease. Moreover, the prolonged incubation times are greatly prolonged upon transmission from humans to a relatively distant species. Generally, the more similar the PrP sequences are for two species, the more readily prions are transmitted between them. After the inoculated animals develop signs of neurologic dysfunction, a progressive impairment of the CNS ensues with death following in a few weeks. With a few exceptions, the neuropathologic changes in animals are roughly similar to those found in humans.

### *Immunologic Studies*

The rapid and reliable diagnosis of CJD postmortem can be accomplished by using antisera to PrP [37,38,50,394]. Initially, partial purification of 1 to 2 grams of infected brain tissue using detergent extractions, differential centrifugation, and enzyme digestions was required to detect PrP<sup>Sc</sup> in 14 cases of CJD analyzed by Western immunoblots [38]. Antibodies raised against Syrian hamster PrP 27-30 were found to react with protease-resistant PrP in the partially purified fractions prepared from human CJD brain. Six of the CJD cases had been previously transmitted to mice and all of these demonstrated the presence of CJD prion proteins. Brains from control patients with anoxic encephalopathy or Alzheimer's disease did not contain these protease-resistant, immunoreactive prion

proteins. Subsequently, two additional procedures were developed for diagnostic evaluations of CJD; one protocol used a dot blot where the sample was first digested with proteinase K and then denatured with GdnHCl [394]. The other protocol was designated histoblotting and utilized the same limited proteolysis followed by GdnHCl denaturation to enhance PrP<sup>Sc</sup> antigenicity [410]. These immunoassays have, for the most part, replaced transmission studies using apes and monkeys.

In one study, 100% of the CJD cases (14/14) examined were found to have PrP immunoreactive proteins that were proteinase K-resistant [38]. In another report, 17 out of 24 CJD cases (71%) showed PrP immunoreactive proteins by immunoblotting with PrP 27-30 antisera [51]. All 24 of those cases had been previously transmitted to apes and monkeys. Since considerable data indicates that PrP<sup>Sc</sup> is required for infectivity [141,350,352], we would expect that almost all cases of authentic, noninherited CJD will contain a protease-resistant isoform of the human PrP [312,334].

In support of this argument that all cases of CJD should have demonstrable PrP<sup>Sc</sup> is our experience with the immunostaining of CJD amyloid plaques. In 16 of 17 CJD cases with amyloid plaques (94%), we have found PrP immunoreactive plaques [247,376,377]. Since all cases of CJD do not have readily identifiable amyloid plaques, immunostaining of tissue sections fixed in formaldehyde and embedded in paraffin is only useful when positive. The use of other fixatives such as McLean's appears to be superior to formaldehyde in preserving PrP antigenicity [111].

We have recently developed a new immunoassay that is likely to supplant earlier qualitative immunoassays that are much less sensitive. This quantitative assay depends on the use of antibodies that react with epitopes of PrP that are exposed in PrP<sup>C</sup> but become buried in PrP<sup>Sc</sup> [342; J. Safar and S.B. Prusiner, manuscript in preparation]. The immunoassay measures the increase in immunoreactivity that occurs when the cryptic epitopes are exposed by denaturation with GdnHCl. The assay is extremely sensitive because the second antibody is labeled with Eu which can be measured by time resolved fluorescence (TRF); in fact the assay is so sensitive that about  $10^5$  PrP<sup>Sc</sup> molecules in a sample can be measured, which is equivalent to one ID<sub>50</sub> unit [353].

### *Care of CJD Patients*

It is important to stress that CJD is neither a contagious nor communicable disease, but that it is transmissible. While the risk of accidental inoculation by aerosols is very small, procedures producing aerosols should be performed in certified biosafety cabinets. Biosafety level 2 practices, containment equipment, and facilities are recommended by the Centers for Disease Control and Prevention and National Institutes of Health [373].

The primary problem in caring for patients with CJD is the inadvertent infection of health care workers by needle and stab wounds, while the possible transmission of a contagion through the air has never been documented. Accidental parenteral inoculation especially with neural tissues and including formalin-fixed specimens is potentially very hazardous [179,307,387,399]. Electroencephalographic and electromyographic needles should not be reused after studies on CJD patients have been performed.



There is no rational, scientific reason for surgeons or nurses to resist performing biopsies on demented patients when this operation is warranted medically. Likewise, there is no reason for pathologists or morgue dieners to resist performing autopsies on patients whose clinical diagnosis was CJD. Progress in the diagnosis, care, and treatment of CJD patients requires the dedicated efforts of physicians, nurses, and other health care workers. The standard microbiologic practices outlined here along with specific recommendations for decontamination seem to be adequate precautions for the care of CJD patients and the handling of infected specimens.

### *Decontamination of CJD Prions*

The scrapie prion is extremely resistant to common inactivation procedures [2,86,145,177,348]. Similar structural features for CJD prions in human brain have recently been described [37].

Procedures for decontamination of CJD-infected materials have been defined [52,56,57,86,145,244,363,440]. While there is general agreement about the extreme resistance of prions to inactivation, there is some disagreement about the optimal conditions for sterilization. Little is known about the resistance of the human CJD prion to inactivation; most of our knowledge comes from animal models of experimental CJD, scrapie, and BSE [281,425-427]. The most widely studied murine CJD model uses an isolate from a Japanese case of GSS [420]. Although some investigators argue that GSS or CJD prions passaged into rodents retain the properties of the human CJD prion [281-283], this view is erroneous and seems to emanate from the old idea that CJD is caused by a slow or unconventional virus. Once human CJD prions are passaged into mice, the resulting prion is a mouse prion. Whether or not this murine CJD prion accurately reflects the properties of human CJD prions from other racial backgrounds remains to be established. It is noteworthy that human CJD prions from British and American patients can rarely be transmitted to mice [158], while most Japanese cases readily transmit [417].

Although some investigators recommend treating CJD-contaminated materials once with 1 N NaOH at room temperature [56,380], we believe this procedure may be inadequate for sterilization. Autoclaving at 132°C for 5 hours or treatment with 2 N NaOH for several hours is recommended for sterilization of prions [363]. The term 'sterilization' implies complete destruction of prions; any residual infectivity can be hazardous.

The greatest possible contamination of hospital equipment will most likely occur in the neurosurgical operating room [451]. Sterilization of surgical instruments by 2 N NaOH or autoclaving at 132°C seems mandatory, especially if the cranium has been opened. By analogy to experimental scrapie, the human CJD brain probably has higher titers of prions than any other organ [130]. Furthermore, the intracerebral route of inoculation of scrapie prions in hamsters is approximately  $10^9$  times more efficient than oral ingestion [354]. These data emphasize the extreme danger of introducing small numbers of prions into the CNS tissue during neurosurgical procedures.

It has been argued that subclinical cases of CJD will harbor high titers of the infectious prions, but these will not be manifested until some time after the surgery is completed when

the patient develops a neurologic disorder. Though this is particularly disconcerting, the rarity of CJD clearly indicates that very few, if any, patients develop CJD as a result of neurosurgical procedures.

The development of Tg mice that detect human prions and extremely sensitive immunoassays for human PrP<sup>Sc</sup> using TRF offers the possibility to assess the resistance of human prions to various sterilization procedures and to develop effective schemes for complete inactivation.

### *Prevention and Therapeutics*

There is no known effective therapy for treating or preventing CJD. There are no well-documented cases of patients with CJD showing recovery either spontaneously or after therapy, with one possible exception [279] for which there is no confirmatory example. Amantadine has been used in the treatment of CJD without any convincing success [44,190,433]. When HPA-23, an inhibitor of viral glycoprotein synthesis, is given to scrapie-infected animals around the time of inoculation, but not later, it profoundly extends the length of the incubation period [242]. The effects in human CJD are uncertain [77]. DEAE dextran and cortisone have also extended the incubation period in experimental scrapie [117,129]. Interferon has been used in experimental scrapie of rodents but the incubation times were unaltered [133,236,455]. Although amphotericin has been used to prolong scrapie incubation periods in rodents [75,345,456], it is not effective in treating patients with CJD [293].

Although antibodies have been raised against the scrapie prion protein and these crossreact with prion proteins in CJD human brains [37], passive immunization or even vaccination would seem to be of little value. CJD and scrapie both progress in the absence of any immune response to the offending prions; however, neutralization of scrapie prion infectivity was accomplished when the infectious particles were dispersed into detergent-lipid-protein complexes [140,383].

As our understanding of prion propagation increases, it should be possible to design effective therapeutics. Because people at risk for inherited prion diseases can now be identified decades before neurologic dysfunction is evident, the development of an effective therapy for these fully penetrant disorders is imperative [85,402]. Although we have no way of predicting the number of individuals who may develop neurologic dysfunction from bovine prions in the future [103], it would be prudent to seek an effective therapy now [1,351]. Interfering with the conversion of PrP<sup>C</sup> into PrP<sup>Sc</sup> seems to be the most attractive therapeutic target [96]. Either stabilizing the structure of PrP<sup>C</sup> by binding a drug or modifying the action of protein X, which might function as a molecular chaperone (Figure 3), are reasonable strategies. Whether it is more efficacious to design a drug that binds to PrP<sup>C</sup> at the protein X binding site or one that mimics the structure of PrP<sup>C</sup> with basic polymorphic residues that seem to prevent scrapie and CJD remains to be determined [234,395]. Since PrP<sup>Sc</sup> formation seems limited to caveolae-like domains [180,232,315,411,438], drugs designed to inhibit this process need not penetrate the cytosol of cells but they do need to be able to enter the CNS. Alternatively, drugs that

destabilize the structure of PrP<sup>Sc</sup> might also prove useful.

The production of domestic animals that do not replicate prions may also be important with respect to preventing prion disease. Sheep encoding the R/R polymorphism at position 171 seem to be resistant to scrapie [22,94,175,211,214,217,219,322,446]; presumably, this was the genetic basis of Parry's scrapie eradication program in Great Britain 30 years ago [335,336]. A more effective approach using dominant negatives for producing prion-resistant domestic animals, including sheep and cattle, is probably the expression of PrP transgenes encoding R171 as well as additional basic residues at the putative protein X binding site (Figure 3) [234]. Such an approach can be readily evaluated in Tg mice and once shown to be effective, it could be instituted by artificial insemination of sperm from males homozygous for the transgene. More difficult is the production of PrP-deficient cattle and sheep. Although such animals would not be susceptible to prion disease [66,358], they might suffer some deleterious effects from ablation of the PrP gene [100,271,384,436].

Whether gene therapy for the human prion diseases using the dominant negative approach described above for prion-resistant animals will prove feasible depends upon the availability of efficient vectors for delivery of the transgene to the CNS.

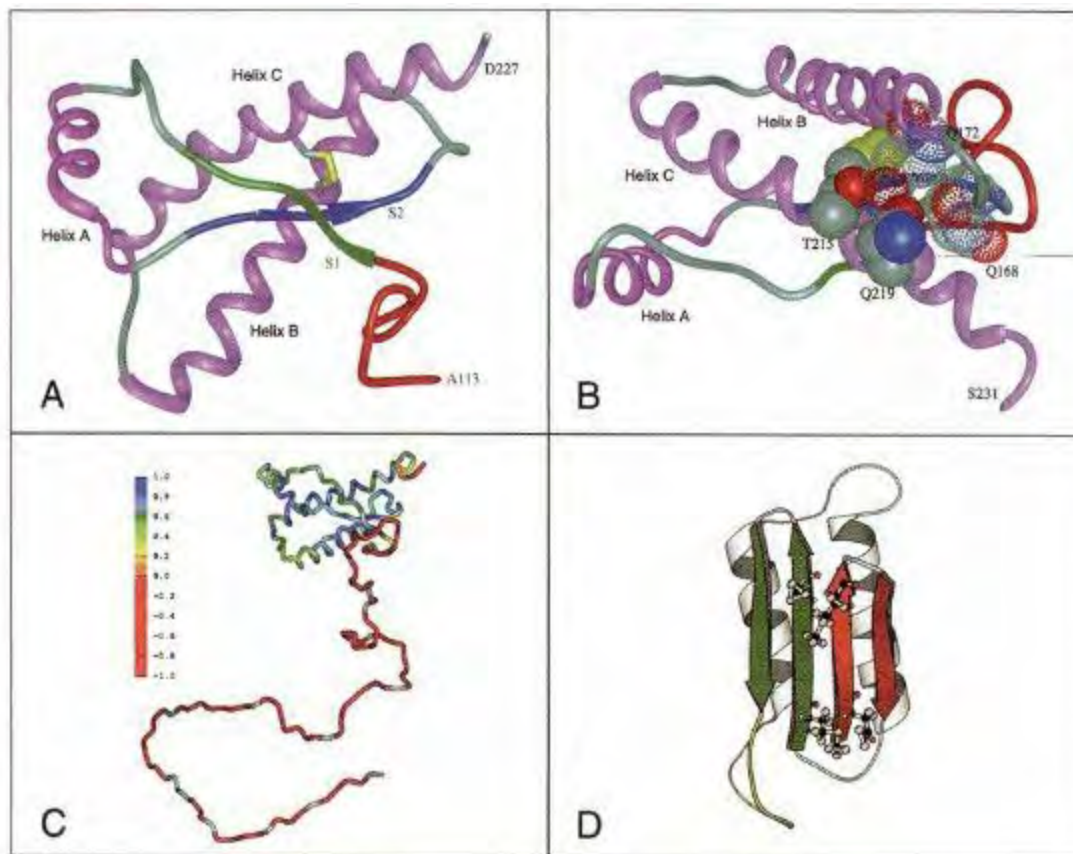

**Figure 3.** Structures of prion proteins.

**(A)** NMR structure of Syrian hamster (SHa) recombinant (r) PrP(90-231). Presumably, the structure of the  $\alpha$ -helical form of rPrP(90-231) resembles that of PrP<sup>C</sup>. rPrP(90-231) is viewed from the interface where PrP<sup>Sc</sup> is thought to bind to PrP<sup>C</sup>. The color scheme is:  $\alpha$ -helices A (residues 144-157), B (172-193), and C (200-227) in pink; disulfide between Cys179 and Cys214 in yellow; conserved hydrophobic region composed of residues 113-126 in red; loops in gray; residues 120-124 in green encompassing strand S1 and residues 150-165 in blue

129-134 in green encompassing strand S1 and residues 159-163 in blue encompassing strand S2; the arrows span residues 129-131 and 161-163, as these show a closer resemblance to  $\beta$ -sheet [225].

**(B)** NMR structure of rPrP(90-231) is viewed from the interface where protein X is thought to bind to PrP<sup>C</sup>. Protein X appears to bind to the side chains of residues that form a discontinuous epitope: some amino acids are in the loop composed of residues 165-171 and at the end of helix B (Gln168 and Gln172 with a low density van der Waals rendering) while others are on the surface of helix C (Thr215 and Gln219 with a high density van der Waals rendering) [234].

**(C)** Schematic diagram showing the flexibility of the polypeptide chain for PrP(29-231) [126]. The structure of the portion of the protein representing residues 90-231 was taken from the coordinates of PrP(90-231) [225]. The remainder of the sequence was hand-built for illustration purposes only. The color scale corresponds to the heteronuclear  $\{^1\text{H}\}$ - $^{15}\text{N}$  NOE data: red for the lowest (most negative) values, where the polypeptide is most flexible, to blue for the highest (most positive) values in the most structured and rigid regions of the protein.

**(D)** Plausible model for the tertiary structure of human PrP<sup>Sc</sup> [208]. Color scheme is: S1  $\beta$ -strands are 108-113 and 116-122 in red; S2  $\beta$ -strands are 128-135 and 138-144 in green;  $\alpha$ -helices H3 (residues 178-191) and H4 (residues 202-218) in gray; loop (residues 142-177) in yellow. Four residues implicated in the species barrier are shown in ball-and-stick form (Asn 108, Met 112, Met 129, Ala 133).

# Infectious Creutzfeldt-Jakob Disease

Infection is a rare cause of prion disease in humans. Iatrogenic CJD, kuru, and possibly variant CJD in Europe are human prion diseases caused by transmission of prions from one host to another.

## *Iatrogenic Creutzfeldt-Jakob Disease*

Accidental transmission of CJD to humans appears to have occurred with corneal transplantation [127], contaminated EEG electrode implantation [25], and surgical operations using contaminated instruments or apparatus [107,253,290,451]. Corneas unknowingly removed from donors with CJD have been transplanted to apparently healthy recipients who developed CJD after prolonged incubation periods. Corneas of animals have significant levels of prions [70] which makes this scenario seem quite probable. The same improperly decontaminated EEG electrodes that caused CJD in two young patients with intractable epilepsy were found to cause CJD in a chimpanzee 18 months after their experimental implantation [26].

Surgical procedures may have resulted in accidental inoculation of patients with prions during their operations [54,145,451], presumably because some instrument or apparatus in the operating theater became contaminated when a CJD patient underwent surgery. Although the epidemiology of these studies is highly suggestive, no proof for such episodes exists.

## *Dura Mater Grafts*

Since 1988, 69 cases of CJD after implantation of dura mater grafts have been recorded [54,82,93,132,262,294,309,320,326,434,453]. All of the grafts were thought to have been acquired from a single manufacturer whose preparative procedures were inadequate to inactivate human prions [54]. One case of CJD occurred after repair of an eardrum perforation with a pericardium graft [409].

## *Human Growth Hormone Therapy*

The possibility of transmission of CJD from contaminated human growth hormone (HGH) preparations derived from human pituitaries has been raised by the occurrence of fatal cerebellar disorders with dementia in 103 patients ranging in age from 10 to 41 years [47,54,65,134]. While one case of spontaneous CJD in a 20-year-old woman has been reported [47,160,329], CJD in patients under 40 years of age is very rare. These patients received injections of HGH every 2 to 4 days for 4 to 12 years [9,33,101,105,160,193,221,230,250,275,285,319,347,435]. Interestingly, most of the patients presented with cerebellar syndromes which progressed over periods varying from 6 to 18 months. Some patients became demented during the terminal phase of their illnesses. In some respects, the clinical courses of some patients with dementia occurring late resemble kuru more than ataxic CJD [357]. Assuming these patients developed CJD

from injections of prion-contaminated HGH preparations, the possible incubation periods range from 4 to 30 years [54]. Incubation periods of two to three decades have been suggested to explain cases of kuru in recent years [148,249,357]. Many patients received several common lots of HGH at various times during their prolonged therapies, but no single lot was administered to all the American patients. How many lots of the HGH might have been contaminated with prions is unknown. HGH from one suspect lot has been reported to transmit disease to one monkey [157] but no confirmatory report has been published.

Although CJD is a rare disease with an incidence of approximately one per million population [290], it is reasonable to estimate that CJD is at least 100 times more common among dead people from whom pituitaries were taken for hormone extractions. Since 10,000 human pituitaries are typically processed in a single HGH preparation, the possibility of hormone preparations contaminated with CJD prions is not remote. The concentration of CJD prions within infected human pituitaries is unknown; it is interesting that widespread degenerative changes have been observed in both the hypothalamus and pituitary of sheep with scrapie [20]. The forebrains from scrapie-infected mice have been added to human pituitary suspensions to determine if prions and HGH copurify [274]. Bioassays in mice suggest that prions and HGH do not copurify with currently used protocols [424]. Although these results seem reassuring, especially for patients treated with HGH over much of the last decade, the relatively low titers of the murine scrapie prions used in these studies may not have provided an adequate test [47]. The extremely small size and charge heterogeneity exhibited by scrapie [3,40,361,362,364] and presumably CJD prions [23,37] may complicate procedures designed to separate pituitary hormones from these slow infectious pathogens. Even though additional investigations argue for the efficacy of inactivating prions in HGH fractions prepared from human pituitaries using 6 M urea [344], it seems doubtful that such protocols will be used for purifying HGH since recombinant HGH is available.

Four cases of CJD have occurred in women receiving human pituitary gonadotropin [95].

### *Variant Creutzfeldt-Jakob Disease*

In 1994, the first cases of CJD in teenagers and young adults that were eventually labeled new variant (v) CJD occurred in Britain [450]. Besides the young age of these patients [17,45], the brains of these patients showed numerous PrP amyloid plaques surrounded by a halo of intense spongiform degeneration (Figure 4A and B) [220]. Later, one French case meeting these criteria followed [87]. These unusual neuropathologic changes have not been seen in CJD cases in the United States, Australia, or Japan [81,220]. Both macaque monkeys and marmosets developed neurologic disease several years after inoculation with bovine prions [16], but only the macaques exhibited numerous PrP plaques similar to those found in vCJD [265; R. Ridley and H. Baker, unpublished data).

### ***Have Bovine Prions Been Transmitted to Humans?***

The restricted geographical occurrence and chronology of vCJD have raised the possibility that BSE prions have been transmitted to humans. Only ~25 vCJD cases have

been recorded and the incidence has remained relatively constant, which makes establishing the origin of vCJD difficult. No set of dietary habits distinguishes vCJD patients from apparently healthy people. Moreover, there is no explanation for the predilection of vCJD for teenagers and young adults. Why have older individuals not developed vCJD-based neuropathologic criteria? It is noteworthy that epidemiological studies over the past three decades have failed to find evidence for transmission of sheep prions to humans [48,102,186,276]. Attempts to predict the future number of cases of vCJD, assuming exposure to bovine prions prior to the offal ban, have been uninformative because so few cases of vCJD have occurred [98,103,369]. Are we at the beginning of a human prion disease epidemic in Britain like those seen for BSE and kuru (Figure 2) or will the number of vCJD cases remain small as seen with iCJD caused by cadaveric HGH [34,101]?

### ***Strain of BSE Prions***

Was a particular conformation of bovine PrP<sup>Sc</sup> selected for heat-resistance during the rendering process and then reselected multiple times as cattle infected by ingesting prion-contaminated MBM were slaughtered and their offal rendered into more MBM? Recent studies of PrP<sup>Sc</sup> from brains of patients who died of vCJD show a pattern of PrP glycoforms different from those found for sCJD or iCJD [99,192]. But the utility of measuring PrP glycoforms is questionable in trying to relate BSE to vCJD [333,401] because PrP<sup>Sc</sup> is formed after the protein is glycosylated [42,80] and enzymatic deglycosylation of PrP<sup>Sc</sup> requires denaturation [131,185]. Alternatively, it may be possible to establish a relationship between the conformations of PrP<sup>Sc</sup> from cattle with BSE and those from humans with vCJD by using Tg mice as was done for strains generated in the brains of patients with FFI or fCJD [391,430]. A relationship between vCJD and BSE has been suggested by finding similar incubation times in non-Tg RIII mice of ~310 days after inoculation with Hu or Bo prions [64].

# Kuru

Kuru devastated the lives of the Fore Highlanders of Papua New Guinea [145]. The high incidence of the disease among women left a society of motherless children raised by their fathers. It was unusual in the Fore region to see an older woman. With the cessation of traditional warfare, older men are now found. Many of these older men have had a succession of wives who each died of kuru after leaving several children. Because contamination during ritualistic cannibalism appears to have been the mode of spread of kuru among the Fore people and since cannibalism had ceased by 1960 in the Fore region, the patients now developing kuru presumably were exposed to the kuru agent more than two decades ago [7,145,161,295]. In many cases, histories have been obtained from patients and their families of the episode in which they cannibalized the remains of a near relative who had died of kuru, which presumably provided the source of infection. That the kuru prions could remain apparently quiescent in these patients for periods of two decades and then manifest themselves in the form of a fatal neurological disease is supported by incubation periods of over 7.5 years in some monkeys inoculated with kuru agent [156].



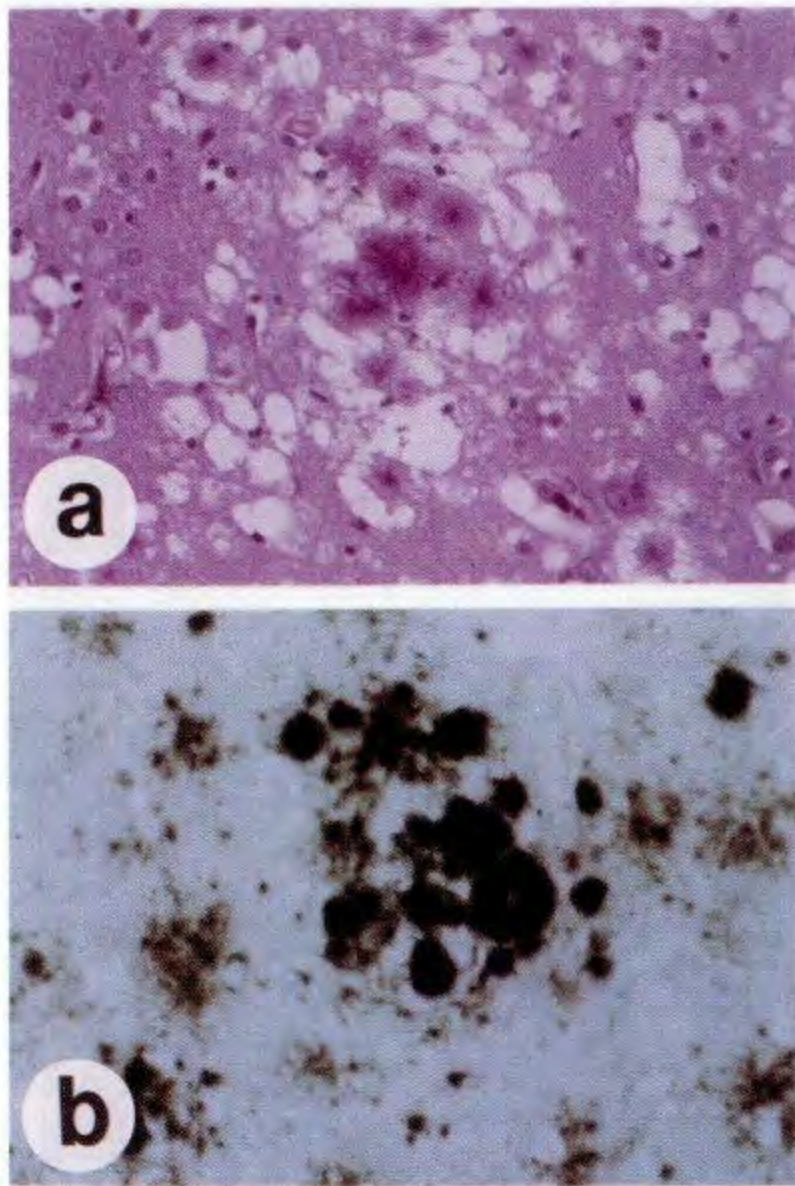

**Figure 4.** Histopathology of variant Creutzfeldt-Jakob disease in Great Britain.

**(a)** Section from frontal cortex stained by the periodic acid Schiff method showing a field with aggregates of plaques surrounded by spongiform degeneration. Magnification X 100.

**(b)** Multiple plaques and amorphous deposits are PrP immunopositive. Magnification X 500.

Specimens provided by James Ironside, Jeanne Bell, and Robert Will; photomicrographs prepared by Stephen J. DeArmond.

The incidence of kuru has progressively declined with the cessation of ritualistic cannibalism in the highlands of New Guinea in the late 1950s (Figure 2B). Each year the youngest kuru cases have been older in accord with the hypothesis that kuru was transmitted by cannibalism [7,145,161,295] even though this proposition has been challenged [11,252]. The lack of eyewitness accounts of cannibalism in the Fore region has caused some scientists to ask if in fact, cannibalism was the route by which kuru was

transmitted.

## *Clinical Features*

In one report describing 15 patients with kuru seen in 1978 and 1980, 13 of these received detailed neurological examinations [357]. Ten of the 15 patients were women, and all were adults. The mean age of all patients was 40.2 years (range, 29 to 60 years), while the mean ages of the 10 women and 5 men were 43.2 years and 34.2 years, respectively. Five men and four women were under 40; all those over 40 were female. The youngest patient, a male, was 29 years old. All but three of the patients lived in the South Fore, the others in the North Fore. The duration of clinical disease ranged from 5 to 22 months, the onset being taken as difficulty walking.

All 15 patients related a history of joint pain preceding the onset of difficulty walking by several months. Eleven of the 15 also reported diffuse headache as a prodromal symptom. The diagnosis of kuru was first made by the patients themselves upon recognizing that they were having difficulty walking. The rugged, mountainous terrain, which is frequently muddy from tropical rains, provided an ample test for assessing their balance on a daily basis.

Eleven of the 15 patients showed no signs of dementia at the time of examination, while four were disoriented and confused and had loss of memory. The latter individuals exhibited speech and frontal lobe release signs consisting of suck, snout, bite, and both hand and foot grasps. Three of the demented patients required a stick to maintain their balance while standing, and one was unable to stand. With advanced kuru, truncal ataxia and tremor were so severe that the stick had to be implanted into earth, and patients with advanced disease were unable to walk without the assistance of another person. In all patients still able to walk with the assistance of a stick or an observer, marked truncal ataxia was evident.

All of the patients exhibited an apprehensive facial expression, which remained unchanged for periods as long as 30 minutes. It could be interrupted, however, by laughter with other members of the village. All patients were able to smile when requested to do so. Examination of the cranial nerves revealed no abnormalities except for ataxic movements of the eyes during tests of conjugate gaze. Optokinetic nystagmus was diminished or absent bilaterally in most kuru patients even at an early stage of the disease.

There was no evidence of muscle wasting or diminished strength, though one patient had coarse fasciculations intermittently in the triceps, quadriceps, and gastrocnemius muscles. No fasciculations of the tongue were observed.

Of the 13 patients who had neurological examinations, four showed increased resistance to passive movements while an additional seven exhibited mild rigidity with demonstrable cogwheeling. The initial clinical descriptions of kuru emphasized this aspect of the disease as well as the cerebellar dysfunction [150,462]. No patient was hypotonic. Nine of the 15 patients exhibited choreiform movements. All 15 had normal strength. In eight of 13 patients, hyperactive deep tendon reflexes were demonstrable but confined to the lower extremities. Seven patients had ankle clonus. Two showed unilateral extensor plantar responses, while two others exhibited bilateral responses. In one case a unilateral extensor plantar response was accompanied by normal deep tendon reflexes. In five patients in

whom clonus at the ankles was readily elicited, no extensor plantar response was seen.

On sensory examination, responses to pinprick, temperature, touch, and vibration were normal. Cortical sensory testing failed to reveal deficits. Marked ataxia of the upper and lower extremities was pronounced in all patients, and all exhibited a prominent intention tremor. Marked difficulties with all tests for coordination were observed. Rapid alternating movements were of uneven amplitude and rhythm.

### *Uniformity of Clinical Signs*

The uniform clinical presentation of kuru is remarkable [5,149,150,197,198,398]. The prodromal symptoms and onset of the disease were similar in all patients of a recent study [357]. Even the time interval between the prodromal symptoms of headache and joint pain and the onset of difficulty walking was always 6 to 12 weeks. In most cases the disease progressed to death within 12 months, and all patients were dead within 2 years of onset. The average duration of illness for the 15 patients in this study was 16 months [357]. Invariably, signs of cerebellar dysfunction dominate the clinical picture. All patients remain ambulatory with the aid of a stick for more than half of the clinical phase of their illness. These clinical characteristics are similar to those reported for adult patients at the peak of the kuru epidemic [5,149,150,197,198,398].

There has been debate about dementia in kuru [5,149,150,197,198,398]. Findings of memory loss and disorientation accompanied by primitive reflexes such as snout, bite, suck, rooting, and hand grasps leave no doubt that patients become demented at an advanced stage of the disease [357]. The same patients also exhibited considerable muscle paratonia or gegenhalten.

The uniformity of presentation and clinical course in kuru contrasts with that of CJD, in which a wide spectrum of clinical manifestations is found [245,379]. While most CJD patients exhibit dementia, myoclonus, and pyramidal tract dysfunction at an early stage of the clinical illness, 10 to 20% present with an ataxic illness [176,458]. However, the dementia appears at an earlier clinical stage in ataxic CJD than in kuru. During the ambulatory phase of disease, no patients with kuru were found to be as severely demented as are most patients with CJD.

### *Incubation Periods that Exceed Three Decades*

No individual born in the South Fore after 1959 has developed kuru. Kuru has progressively disappeared, first among children and thereafter among adolescents. The number of deaths in adult females has decreased steadily and adult male deaths have remained almost invariant. No one born in a village since cannibalism ceased has ever developed kuru [6,7]. Each year the youngest new patients are older than those of the previous year. These observations predict no kuru victims under the age of 40 within 7 years.

Of several hundred kuru orphans born since 1957 to mothers dying of kuru, none has yet developed the disease. Thus, the many children with kuru seen in the 1950s were not infected prenatally, perinatally, or neonatally by their mothers. There is no evidence for

transmission in utero or by human milk. The regular disappearance of kuru is inconsistent with the existence of any natural reservoirs for kuru besides humans. Indeed, there is no evidence for animal or insect reservoirs.

While patients currently afflicted with kuru exhibit greatly prolonged incubation periods, children with kuru who were observed 30 years ago provide some information on the minimum incubation period. The youngest patient with kuru was 4 years old at the onset of the disease and died at age 5. It is not known at what age young children were infected. Accidental transmission of CJD to humans has required only 18 months after intracerebral or intraoptic inoculation [25,127]. An incubation period of 18 months has also been found in chimpanzees inoculated intracerebrally with the kuru agent.

### *Transmission by Cannibalism*

Considerable evidence implicates ritualistic cannibalism as the mode of transmission for kuru among the Fore and neighboring tribes [145]. Oral transmission of kuru to monkeys has been documented [156]. Proposed transmission routes through laceration of the skin and rubbing of the eyes remains to be established [145]. These routes were suggested when early experiments on oral transmission to apes and monkeys failed. The experimental results from oral transmission of scrapie to hamsters suggests that insufficient doses of the kuru agent or prions were used in those protocols [354].

### *Origin of Kuru*

It has been suggested that kuru began at the turn of the century as a spontaneous case of CJD that was propagated by ritualistic cannibalism [7,145]. Whether or not the Fore people and their immediate neighbors provide an especially permissive genetic background that allows multiplication of kuru prions remains to be established. Sequencing of the open reading frame of the PrP gene from three kuru patients failed to reveal any mutations [164]. Noteworthy is a case of CJD outside the kuru region in Papua New Guinea.

### *Transmission to Animals*

Kuru has been regularly transmitted after intracerebral inoculation to apes and monkeys [145,147]. Occasional cases have been transmitted to cats but not to rodents [158]. The prolonged incubation periods in experimental animals are similar to those observed with CJD and GSS. Oral transmission of kuru to apes and monkeys has been difficult [145], but recent studies have demonstrated transmission to monkeys [156]. Presumably, the difficulties transmitting human kuru prions to apes and monkeys orally are due to the inefficiency of this route [354] and the crossing of a species barrier.

### *Immunologic Studies*

Using PrP antiserum, protease-resistant immunoreactive proteins have been demonstrated in the brain extracts of one out of two patients (50%) dying of kuru [50]. Presumably, these two patients are included in a larger series where three out of four kuru

patients (75%) were found to have the abnormal isoforms of the prion protein [51].

# Gerstmann-Sträussler-Scheinker Disease

Gerstmann-Sträussler-Scheinker disease (GSS), also known as Sträussler's disease and Gerstmann-Sträussler syndrome, was first described by Gerstmann and coworkers in 1936 [152]. This syndrome originally referred to a familial condition, but sporadic cases clinically and pathologically resembling GSS have been reported and are now generally included under the same rubric [260,286]. The different clinical presentations of GSS suggested that it may be a heterogeneous disorder and it was defined as a "spinocerebellar ataxia with dementia and plaque-like deposits" [393].

Molecular genetic investigations of GSS have defined four syndromes each with a different PRNP gene point mutation. An ataxic form of GSS is caused by a point mutation at codon 102 [199]; this mutation was also found in the original family described by Gerstmann, Sträussler, and Scheinker [152,255]. While a telencephalic form of GSS [321] was eventually shown to be caused by a mutation at codon 117 [124,203], an ataxic form caused by the same mutation has also been recorded [292]. A form of GSS in which ataxia is often accompanied by Parkinsonism and dementia is genetically linked to a PRNP mutation at codon 198 [122,200]. In the codon 198 form of GSS and another caused by a mutation at codon 217, PrP amyloid plaques are found surrounded by numerous neurofibrillary tangles (NFTs) [153,154].

## *Epidemiology*

GSS is rare [14,125,209,260,286,341] and comprises less than 2% of nearly 1,000 cases of CJD or CJD-related diseases [286]. Assuming that the incidence of CJD is less than one per million, a rough estimate of the incidence of GSS is less than two per hundred million. This estimate may underrepresent GSS, since GSS frequently resembles other chronic degenerative diseases such as spinocerebellar degeneration, olivopontocerebellar degeneration, and multiple sclerosis [286].

All reported cases of GSS have originated in the northern hemisphere — in Europe, Canada, the United States, and Japan [14,125,209,260,286,341]. Cases from the southern hemisphere will undoubtedly be recognized in the future.

## *Clinical Features*

The diversity of clinical manifestations in GSS, even within the same pedigree, is well documented; however, patients typically complain of difficulty walking and unsteadiness, sometimes accompanied by leg pains or paresthesias in the early stages of the disease. On examination, cerebellar ataxia, dysarthria, ocular dysmetria, hypo- or areflexia in the lower extremities with extensor plantar responses, and mild wasting or weakness in the lower extremities may be found. Hypo- or areflexia in the lower extremities may be helpful in distinguishing GSS from dominantly-inherited olivopontocerebellar degenerations. Sensory disturbances, usually impairment of vibratory and proprioceptive sensations, are occasionally detected on examination. Later in the course, mental deterioration may occur; sometimes it is quite mild or is difficult to assess because of severe dysarthria. Dysphagia

frequently develops and contributes to inanition in the late stages of disease. Deafness, blindness, gaze palsies, and extrapyramidal rigidity have been reported in several cases. Convulsions may occur but are rare. Myoclonus seldom occurs, and when it does may be confined to the lower extremities.

The majority of patients present with symptoms in the fourth to sixth decades. The average age of onset is 43 years old and ranges from 24 to 66 years old. Symptoms may initially be relapsing, and thus GSS can be mistaken for multiple sclerosis. Eventually, inexorable progression of symptoms leads to death. The duration of illness ranges from 1 to 11 years with a mean of 5 years. The mean age at death is 48 years. The age of onset may vary as much as three decades within a single pedigree [209].

Clinically, GSS is thought to be distinguished from CJD by the prominence of ataxia in the former and the prominence of dementia with myoclonus in the latter. Yet, paradoxically, the clinical manifestations of both GSS and CJD may occur in different members of the same family. In one such family, the characteristic amyloid plaques of GSS were found in all afflicted members, including one member who died with rapidly progressive dementia and myoclonus clinically consistent with CJD [286,382]. This patient's father and sister had both been afflicted with slowly progressive ataxia and little or no accompanying dementia as is characteristic for GSS. Such a pedigree raises the question of whether CJD and GSS are distinct entities and perhaps demonstrates how a single allele can be variably expressed against different genetic backgrounds.

GSS and kuru are different in duration of clinical illness (up to 5 years in GSS versus 1 to 2 years in kuru), morphology of amyloid plaques (multicentric in GSS versus unicentric in kuru), and mode of transmission (vertical in GSS versus horizontal in kuru). The symptoms and distribution of neuropathologic lesions in GSS and kuru are strikingly similar, however, thus also calling into question whether they are separate diseases.

### *Genetics and Diagnostic Evaluation*

Most cases of GSS are familial [286], exhibiting an autosomal dominant pattern with nearly complete penetrance. The premortem diagnosis of GSS is secure if a nonconservative mutation of the PrP gene is found [202]. Prior to the discovery of PrP gene mutations causing GSS, the diagnosis of GSS was rarely made prior to autopsy. Biopsy of the cerebellum was occasionally diagnostic when PrP amyloid plaques were found. Serologic and CSF examinations are normal. Computerized axial tomography of the brain sometimes reveals cerebellar and brainstem atrophy. The EEG is normal or shows nonspecific, diffuse changes. Periodic complexes have not been reported in GSS except in those cases whose clinical manifestations resembled CJD. Electromyography may reveal denervation potentials in lumbosacral myotomes. Sensory and motor nerve conduction velocities are normal.

### *Transmission to Animals*

In 1978, Tateishi and coworkers produced experimental spongiform encephalopathy in mice and rats by using brain tissue from a patient with a chronic spongiform encephalopathy

and kuru plaques [418,420]. Although this case was not thought to be familial at the time, its clinicopathologic features resembled GSS, and subsequently Masters suggested that this case be classified as GSS [286]. In 1981, transmission of GSS to monkeys using brain tissue from a patient with familial disease was reported [286]. Subsequently, brain tissue from another afflicted member of the same family was used to transmit disease to marmosets [15]. No diagnostic conclusions can as yet be made from such transmission studies because transmissibility of GSS appears to be variable, even within a single pedigree [15,286].

### *Immunologic Studies*

Using PrP antiserum, protease-resistant immunoreactive proteins have been demonstrated in the brain extracts of two out of four patients (50%) with GSS [50]. Presumably, these two patients are included in a second report where three out of four GSS patients (75%) were stated to have the abnormal isoforms of the prion protein [51]. Partially purified protease-resistant prion proteins from the brain of one patient dying of GSS were found to be PrP immunoreactive on Western immunoblots [38]. Subsequent studies with larger numbers of GSS patients have documented the PrP immunoreactivity of amyloid plaques and the presence of PrP<sup>Sc</sup> [415,416]. A dot-blot procedure for detection of PrP<sup>Sc</sup> in brain homogenates provides a rapid and reliable method for the diagnosis of GSS provided multiple regions of the brain are sampled [394]. Isolation of amyloid plaques from the brains of GSS patients and subsequent purification and sequencing of a major 11-kDa protein has shown that this protein is a proteolytic fragment of PrP extending from 58 to 150 [407,408].



# Neuropathology of the Human Prion Diseases

The triad of microscopic features that characterizes the prion diseases consists of 1) spongiform degeneration of neurons, 2) severe astrocytic gliosis which often appears to be out of proportion to the degree of nerve cell loss, and 3) amyloid plaque formation [20,61,112-114,159,286,287,419,454].

Spongiform degeneration consists of intracellular vacuoles that focally dilate neuronal processes, which gives the gray matter a microvacuolated appearance by light microscopy. Ultrastructurally, the vacuoles display splitting of the unit cell membrane with the formation of blister-like membrane expansions and multiple septae [92]. In addition, the abnormal single-component membranes are focally thickened and necrotic. These neuronal membrane alterations as primary targets of the disease strongly correlate with the prion protein being an integral membrane sialoglycoprotein [40,188,298,306,348,353], which, during the course of the disease, accumulates in neuronal cell membranes.

## *Selective Neuronal Targeting*

In addition to incubation times, neuropathologic profiles of spongiform change have been used to characterize prion strains [136]. Recent studies with PrP transgenes, however, argue that such profiles are not an intrinsic feature of strains [74,115]. The mechanism by which prion strains modify the pattern of spongiform degeneration was perplexing since earlier investigations had shown that PrP<sup>Sc</sup> deposition precedes neuronal vacuolation and reactive gliosis [111,189,229]. When FFI prions were inoculated into Tg(MHu2M) mice, PrP<sup>Sc</sup> was confined largely to the thalamus (Figure 5A) as is the case for FFI in humans [301,430]. In contrast, fCJD(E200K) prions inoculated into Tg(MHu2M) mice produced widespread deposition of PrP<sup>Sc</sup> throughout the cortical mantle and many of the deep structures of the CNS (Figure 5B), as is seen in fCJD(E200K) in humans. To examine whether the diverse patterns of PrP<sup>Sc</sup> deposition are influenced by Asn-linked glycosylation of PrP<sup>C</sup>, we constructed Tg mice expressing PrPs mutated at one or both of the Asn-linked glycosylation consensus sites [115]. These mutations resulted in aberrant neuroanatomic topologies of PrP<sup>C</sup> within the CNS, whereas pathologic point mutations adjacent to the consensus sites did not alter the distribution of PrP<sup>C</sup>. Tg mice with mutation of the second PrP glycosylation site exhibited prion incubation times of >500 days and unusual patterns of PrP<sup>Sc</sup> deposition. These findings raise the possibility that glycosylation can modify the conformation of PrP and affect either the turnover of PrP<sup>C</sup> or the clearance of PrP<sup>Sc</sup>. Regional differences in the rate of deposition or clearance would result in specific patterns of PrP<sup>Sc</sup> accumulation.

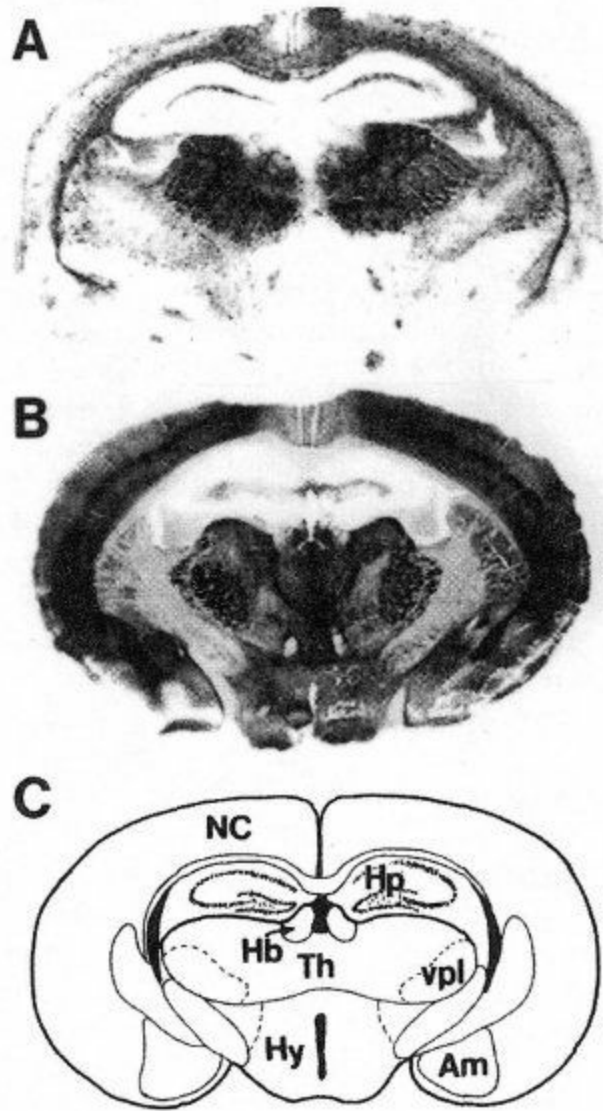

**Figure 5.** Regional distribution of PrP<sup>Sc</sup> deposition in Tg(MHu2M)Prnp<sup>0/0</sup> mice inoculated with prions from humans who died of inherited prion diseases.

Histoblot of PrP<sup>Sc</sup> deposition in a coronal section of a Tg(MHu2M)Prnp<sup>0/0</sup> mouse through the hippocampus and thalamus [430].

**(A)** The Tg mouse was inoculated with brain extract prepared from a patient who died of FFI.

**(B)** The Tg mouse was inoculated with extract from a patient with fCJD(E200K). Cryostat sections were mounted on nitrocellulose and treated with proteinase K to eliminate PrP<sup>C</sup> [410]. To enhance the antigenicity of PrP<sup>Sc</sup>, the histoblots were exposed to 3M guanidinium isothiocyanate before immunostaining using  $\alpha$ -PrP 3F4 mAb [235].

**(C)** Labeled diagram of a coronal section of the hippocampus/thalamus region. NC, neocortex; Hp, hippocampus; Hb, habenula; Th, thalamus; vpl, ventral posterior lateral thalamic nucleus; Hy, hypothalamus; Am, amygdala.

## *Neuropathology of CJD*

Frequently, the brains of patients with CJD show no recognizable abnormalities upon gross examination. In patients surviving several years, variable degrees of cerebral atrophy are likely to result in brain weights as low as 850g.

The pathologic hallmarks of CJD at the light microscopic level are spongiform degeneration and astrogliosis. The lack of an inflammatory response in CJD and other prion diseases is an important pathologic feature of these degenerative disorders. Generally, the spongiform changes occur in the cerebral cortex, putamen, caudate nucleus, thalamus, and molecular layer of the cerebellum [18,35,261]. Spongiform degeneration is characterized by many 1 to 5  $\mu\text{m}$  vacuoles in the neuropil between nerve cell bodies [290]. By electron microscopy, the vacuoles appear to be swollen neuronal processes and seem to be surrounded by a membrane [19,261]. Frequently, many membrane fragments can be seen within them. In some brains with CJD, we have seen no recognizable spongiform degeneration. The white matter is generally devoid of lesions, but several cases of CJD in Japan have exhibited well documented vacuolar changes [412]. In natural scrapie of sheep, vacuolization is very limited [463], while experimental scrapie of rodents is accompanied by widespread vacuolar changes. In transmissible mink encephalopathy, generally there is widespread vacuolation, but infected Aleutian mink fail to show vacuolar changes [284]. Thus, vacuolation, while a common feature of prion diseases, does not seem to be an obligatory change.

Astrogliosis is a more constant but nonspecific feature of prion diseases. Widespread proliferation of fibrous astrocytes is found throughout the gray matter of brains infected with CJD prions. Astrocytic processes filled with glial filaments form extensive networks. Whether or not prions possess some glial growth or maturation activity remains to be established. Alternatively, changes in neuronal function may provoke this attendant gliosis.

Amyloid plaques have been found in 5 to 10% of CJD cases. Purified CJD prions from humans and animals exhibit the ultrastructural and histochemical characteristics of amyloid [37,364]. In first passage from some human Japanese CJD cases, amyloid plaques have been found in mouse brains [413]. These plaques stain with antisera raised against scrapie hamster PrP 27-30 protein [247,376,377].

The majority of cases of kuru show plaques that are presumably comprised of amyloid within their cores [18,248]. The kuru plaques differ from senile plaques in that senile plaques have a collection of amorphous material, presumably degenerating dendrites around their amyloid core. The kuru plaques do not possess such a large halo. Both kuru and senile plaques have been reported in CJD, but they are not a constant feature of the disease [91,457]. Kuru plaques seem to be a constant feature of GSS [286,392].

## *Neuropathology of GSS*

The neuropathologic diagnosis of GSS is based upon the presence of characteristic amyloid plaque deposition, degeneration of white matter tracts, and neuronal loss throughout the brain, variably accompanied by spongiform changes and gliosis. The distribution and extent of these neuropathologic changes differs widely between patients,

even within one pedigree.

The amyloid plaques of GSS are distinct from those seen in kuru, Alzheimer's disease, or scrapie. GSS plaques consist of a central dense core of amyloid surrounded by smaller globules of amyloid. Ultrastructurally, they consist of a radiating fibrillar network of amyloid fibrils with scant or no neuritic degeneration. The plaques can be distributed throughout the brain but are most frequently found in the cerebellum. They are often located adjacent to blood vessels. Congophilic angiopathy has been noted in some cases of GSS. In addition to the multicentric plaques of GSS, unicentric kuru plaques may also be seen [286].

In numerous cases of GSS, there are PrP-immunoreactive proteins within the amyloid plaques [110,247,377]. Thus, like CJD and kuru, the amyloid plaques of GSS specifically stain with antisera raised against PrP 27-30 isolated from scrapie-infected hamster brains. PrP immunostaining of formalin-fixed brain embedded in paraffin blocks as well as dot blot immunostaining of PrP<sup>Sc</sup> in brain homogenates can be used to establish the diagnosis of GSS [247,394].

The pattern of white matter degeneration resembles that of other system degenerations, such as hereditary spinocerebellar degeneration (Friedreich's), cerebellar degeneration (Marie), and dentatorubral degeneration (Ramsay Hunt). The principal tracts involved include the dorsal and ventral spinocerebellar tracts, the posterior columns, the superior, middle, and inferior cerebellar peduncles, and the corticospinal tracts.

Neuronal loss occurs in scattered areas throughout the brain and spinal cord. The nuclei and regions which may be affected include Clarke's column, anterior horn cells, vestibular and cochlear nuclei, dentate nuclei, Purkinje and granule cells in the cerebellum, pontine nuclei, inferior olive, thalamus, substantia nigra, striatum, globus pallidus, subthalamic nucleus, and all layers of the cerebral cortex and hippocampus.

The presence of spongiform changes can vary even within a given pedigree [286]. Transmission of GSS to experimental animals was achieved only in cases with severe spongiform changes [286] until Tateishi and coworkers demonstrated transmission to rodents from a case of GSS with minimal spongiform changes [421].

Prior to the availability of immunocytochemical analyses for PrP, some cases of GSS were incorrectly diagnosed as familial Alzheimer's disease since histochemistry showed NFTs and amyloid plaques of the Alzheimer type [14,191]. While NFTs confined to the hippocampus may be incidental, the distribution of NFTs throughout the cerebral cortex along with plaques suggests Alzheimer's disease or the simultaneous occurrence of Alzheimer's disease and GSS [14]. Subsequent immunostaining studies have shown that the amyloid plaques in some of these cases are composed of prion proteins and do not bind antibodies raised to the  $\beta$ -amyloid peptide [154,218,321,406]. Molecular genetic investigations elucidated the point mutations of the PrP gene point mutations in each of these prion disorders.

### *Neuropathology of Kuru*

The neuropathologic changes in kuru are much like those described for CJD and GSS. Spongiform changes, astrogliosis, and amyloid or "kuru" plaques are the pathologic

hallmarks of kuru. Most but not all cases of kuru exhibit amyloid plaques [248]. These plaques have been found to contain prion proteins by immunostaining [377].

# Inherited Human Prion Diseases

By 1930, a pedigree of the Backer family with multiple members apparently afflicted with CJD was published [302,405]. Subsequently, there were many reports of familial cases of CJD [41,245,287,288,317,382], and in 1973, the first fCJD cases transmitted to apes and monkeys were reported [379]. These transmission studies followed earlier findings of the transmissibility of sporadic CJD and kuru of the Fore to apes and monkeys [147,159]. Subsequently, isolation of the “CJD virus” from members of families with GSS and with Alzheimer’s disease was reported [286,287]. These findings were interpreted within the framework of a viral illness occurring more frequently in some families than in others. Explanations offered for such data included: 1) spread of the CJD virus among family members living in close proximity, 2) an inherited predisposition to infection with the ubiquitous CJD virus, and 3) vertical transmission of the CJD virus from parent to offspring.

Unrelated to the foregoing observations, which had apparently provided a reasonable explanation, were developments that subsequently provided a molecular basis for diseases that are manifested as infectious, sporadic, or genetic illnesses. In these seemingly unrelated studies, a protein unique to scrapie-infected hamster brains was discovered by progressively enriching fractions for scrapie infectivity [39,353]. The protein called PrP 27-30 was subjected to Edman degradation and the N-terminal amino acid sequence determined [359]. Knowledge of the PrP 27-30 sequence permitted synthesis of oligonucleotide probes that permitted recovery of cognate molecular clones encoding the protein [89,325]. Subsequently, molecular clones of the human PrP gene were sequenced [257,367] and mutations were found in both fCJD and GSS [199,328]. A genetic linkage study showed that the P102L mutation in the PrP gene was likely to be the cause of GSS [199].

With the discovery of PrP gene mutations in the familial prion diseases, it was possible to explain how a single pathogenic process could give rise to infectious, sporadic, and genetic illnesses. Within the framework of the prion hypothesis rather than the spread of a virus, it was possible to construct a consistent scenario [349]. This new framework was particularly significant because concurrent epidemiologic studies failed to demonstrate an infectious etiology for sporadic CJD, which is the most common form [48,102,276,452]. It should be mentioned, however, that some investigators interpreted the finding of PrP mutations as evidence for a mutant viral receptor that increases the likelihood of infection by a highly ubiquitous virus [78,166,168,240].

As evidence supporting the prion hypothesis accumulated, many additional PrP gene mutations were found in family members afflicted with heritable prion diseases. Moreover, genetic linkage of different PrP gene mutations with the development of neurologic disease [122,143,343,346] and the production of transgenic mice that developed spontaneous disease when expressing mutant PrP [204,205] made the virus scenario increasingly unlikely.

## *Human PrP Gene Mutations*

## **GSS**

The discovery of a proline (P)→ leucine (L) mutation at codon 102 of the human PrP gene that was genetically linked to GSS permitted the unprecedented conclusion that prion disease can have both genetic and infectious etiologies [199,349]. In that study, the codon 102 mutation was linked to development of GSS with a logarithm of the odds (LOD) score exceeding 3, demonstrating a tight association between the altered genotype and the disease phenotype (Figure 1). This mutation may be caused by the deamination of a methylated CpG in a germline PrP gene resulting in the substitution of a thymine (T) for cytosine (C). This mutation has been found in many families in numerous countries, including the original GSS family [124,170,255].

### ***fCJD Caused by Octarepeat Inserts***

An insert of 144 bp containing six octarepeats at codon 53, in addition to the five that are normally present, was described in patients with CJD from four families residing in southern England [328,346]. Genealogical investigations have shown that all four families are related, arguing for a single founder born more than two centuries ago. The LOD score for this extended pedigree exceeds 11. Studies from several laboratories have demonstrated that inserts of two, four, five, six, seven, eight, or nine octarepeats in addition to the normal five are found in individuals with inherited CJD (Figure 1) [165,328].

### ***fCJD in Libyan Jews***

The unusually high incidence of CJD among Israeli Jews of Libyan origin was thought to be due to the consumption of lightly cooked sheep brain or eyeballs [231]. Molecular genetic investigations revealed that Libyan and Tunisian Jews with fCJD have a PrP gene point mutation at codon 200 resulting in a Glu→Lys substitution (Figure 1) [168,201]. The E200K mutation has been genetically linked to the mutation with a LOD score exceeding 3 [143] and the same mutation has also been found in patients from Orava in North Central Slovakia [168], in a cluster of familial cases in Chile [166], and in a large German family living in the United States [27].

Most patients are heterozygous for the mutation and thus, express both mutant and wild type (wt) PrP<sup>C</sup>. In the brains of patients who die of fCJD(E200K), the mutant PrP<sup>Sc</sup> is both insoluble and protease resistant while much of wt PrP differs from both PrP<sup>C</sup> and PrP<sup>Sc</sup> in that it is insoluble but readily digested by proteases. Whether this form of PrP is an intermediate in the conversion of PrP<sup>C</sup> to PrP<sup>Sc</sup> remains to be established [144].

### ***Penetrance of fCJD***

Life table analyses of carriers harboring the codon 200 mutation exhibit complete penetrance [85,402]. In other words, if the carriers live long enough, they will all eventually develop prion disease. Some investigators have argued that the inherited prion diseases are not fully penetrant and thus an environmental factor such as the ubiquitous 'scrapie virus'

is required for illness to be manifested but as reviewed above, no viral pathogen has been found in prion disease [163,166].

### ***Fatal Familial Insomnia***

Studies of inherited human prion diseases demonstrate that changing a single polymorphic residue at position 129 in addition to the D178N pathogenic mutation alters the clinical and neuropathologic phenotype. The D178N mutation combined with a Met encoded at position 129 results in a prion disease called fatal familial insomnia (Figure 1) [169,300]. In this disease, adults generally over age 50 present with a progressive sleep disorder and usually die within about a year [273]. In their brains, deposition of PrP<sup>Sc</sup> is confined largely within the anteroventral and the dorsal medial nuclei of the thalamus. The D178N mutation has been linked to the development of FFI with a LOD score exceeding 5 [343]. More than 30 families worldwide with FFI have been recorded [151]. In contrast, the same D178N mutation with a Val encoded at position 129 produces fCJD in which the patients present with dementia and widespread deposition of PrP<sup>Sc</sup> is found postmortem [167]. The first family to be recognized with CJD was recently found to carry the D178N mutation [256,302].

### ***Human PrP Gene Polymorphisms***

The M→V polymorphism at position 129 [327] appears able to influence prion disease expression not only in inherited forms, but also in iatrogenic and sporadic forms of prion disease (Figure 1). A second polymorphism resulting in an amino acid substitution at codon 219 (E→K) has been reported to occur with a frequency of about 12% in the Japanese population but not in Caucasians [246]. A third polymorphism is the deletion of a single octarepeat (24 bp) which has been found in 2.5% of Caucasians [83,264,439]. In another study of over 700 individuals, this single octarepeat was found in 1.0% of the population [331].

Studies of Caucasian patients with sCJD have shown that most are homozygous for Met or Val at codon 129 [330]. This contrasts with the general population, in which frequencies for the codon 129 polymorphism in Caucasians are 12% V/V, 37% M/M, and 51% M/V [97]. In contrast, the frequency of the Val allele in the Japanese population is much lower [123,310] and heterozygosity at codon 129 (M/V) is more frequent (18%) in CJD patients than in the general population where the polymorphism frequencies are 0% V/V, 92% M/M, and 8% M/V [414].

While no specific mutations have been identified in the PrP gene of patients with sporadic CJD [164], homozygosity at codon 129 in sCJD [330] is consistent with the results of Tg mouse studies. The finding that homozygosity at codon 129 predisposes to sCJD supports a model of prion production which favors PrP interactions between homologous proteins, as appears to occur in Tg mice expressing Syrian hamster (SHa) PrP inoculated with either hamster prions or mouse prions [350,365,388], as well as Tg mice expressing a chimeric SHa/Mo PrP transgene inoculated with 'artificial' prions [389].



## *De Novo Generation of Prions in Tg Mice Expressing Mutant PrP*

Introduction of the codon 102 point mutation found in GSS patients into the MoPrP gene resulted in Tg(MoPrP-P101L) mice that developed CNS degeneration indistinguishable from experimental murine scrapie, with neuropathology consisting of widespread spongiform morphology, astrocytic gliosis, and PrP amyloid plaques [204,429]. Brain extracts prepared from spontaneously ill Tg(MoPrP-P101L) mice transmitted CNS degeneration to Tg196 mice [204,429]. The Tg196 mice express low levels of the mutant transgene MoPrP-P101L and do not develop spontaneous disease whereas the Tg(MoPrP-P101L) mice expressing high levels of the mutant transgene product do develop CNS degeneration spontaneously. These studies, as well as transmission of prions from patients who died of GSS to apes, monkeys [286], and Tg(MHu2M-P102L) mice [432], argue persuasively that prions are generated *de novo* by mutations in PrP. In contrast to species-specific variations in PrP, all of the known point mutations in PrP occur either within or adjacent to regions of putative secondary structure in PrP and as such, appear to destabilize the structure of PrP [207,375,460].

The initial attempt to detect *de novo* production of prions in uninoculated Tg(MoPrP-P101L) mice used non-Tg CD-1 mice, Syrian hamsters, and the Tg196 mice [204]. None of the CD-1 mice developed disease while many of the Syrian hamsters did. We chose Syrian hamsters not as negative controls but because these animals have relatively short incubation times and thus, are sensitive hosts for prion formation. How the presence of a Leu at codon 102 might alter binding of mutant PrP<sup>Sc</sup> to wt PrP<sup>C</sup> is unknown, but its place in the central region of PrP suggested the position is critical. Not unexpectedly, Tg196 mice expressing the mutant transgene proved to be the best hosts. It is noteworthy that extracts from the brains of patients who died with GSS (P102L) have transmitted disease to Tg(MHu2M-P102L) mice but not to Tg(MHu2M) mice [432]. In contrast, human prions from patients with sCJD, fCJD(E200K), and FFI have all transmitted disease to Tg(MHu2M) mice [430,432].

Why mutations of the PrP gene that produce seemingly unstable PrP<sup>C</sup> molecules require many decades in humans to be manifested as CNS dysfunction is unknown. In Tg(MoPrP-P101L) mice, the level of expression of the mutant transgene is inversely related to the age of disease onset. In addition, the presence of the wt MoPrP gene slows the onset of disease and diminishes the severity of the neuropathological changes.

# Prion Replication

In an uninfected cell, PrP<sup>C</sup> with the wt sequence exists in equilibrium in its monomeric  $\alpha$ -helical, protease-sensitive state or bound to protein X (Figure 6). We denote the conformation of PrP<sup>C</sup> that is bound to protein X as PrP\* [96]; this conformation is likely to be different from that determined under aqueous conditions for monomeric recombinant PrP. The PrP\*/protein X complex will bind PrP<sup>Sc</sup>, thereby creating a replication competent assembly. Order of addition experiments demonstrate that for PrP<sup>C</sup>, protein X binding precedes productive PrP<sup>Sc</sup> interactions [234]. A conformational change takes place wherein PrP, in a shape competent for binding to protein X and PrP<sup>Sc</sup>, represents the initial phase in the formation of infectious PrP<sup>Sc</sup>. It is noteworthy that PrP\* has also been used to denote a subgroup of PrP<sup>Sc</sup> molecules that are infectious [443]; however, we have no evidence for such a subset.

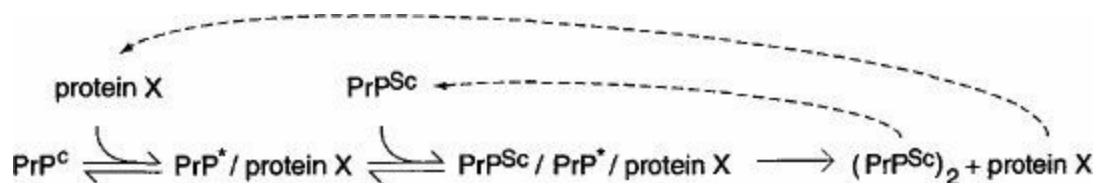

**Figure 6.** Schematic diagram showing template assisted PrP<sup>Sc</sup> formation.

In the initial step, PrP<sup>C</sup> binds to protein X to form the PrP\*/protein X complex. Next, PrP<sup>Sc</sup> binds to PrP\* that has already formed a complex with protein X. When PrP\* is transformed into a nascent molecule of PrP<sup>Sc</sup>, protein X is released and a dimer of PrP<sup>Sc</sup> remains. The inactivation target size of an infectious prion suggests that it is composed of a dimer of PrP<sup>Sc</sup> [21]. In the model depicted here, a fraction of infectious PrP<sup>Sc</sup> dimers dissociate into uninfected monomers as the replication cycle proceeds while most of the dimers accumulate in accord with the increase in prion titer that occurs during the incubation period. The precise stoichiometry of the replication process remains uncertain.

Several lines of evidence argue that the smallest infectious prion particle is an oligomer of PrP<sup>Sc</sup>, perhaps as small as a dimer [21,362]. Upon purification, PrP<sup>Sc</sup> tends to aggregate into insoluble multimers that can be dispersed into liposomes [141,299]. Insolubility does not seem to be a prerequisite for PrP<sup>Sc</sup> formation or prion infectivity, as suggested by some investigators [79,146,228]; a protease-resistant PrP<sup>Sc</sup> that is soluble in 1% Sarkosyl was generated in ScN2a cells by expression of a PrP deletion mutant consisting of 106 amino acid residues [314]. Although Tg mice expressing PrP106 support the replication of prion infectivity, additional studies are needed to determine whether or not prion infectivity is preserved under conditions where PrP<sup>Sc</sup>106 is soluble [S. Supattapone *et al.*, manuscript in preparation].

In attempts to form PrP<sup>Sc</sup> *in vitro*, PrP<sup>C</sup> was exposed to 3 M GdnHCl and then diluted 10-fold prior to binding to PrP<sup>Sc</sup> [233,251]. Based on these results, we presume that

exposure of PrP<sup>C</sup> to GdnHCl converts it into a PrP<sup>\*</sup>-like molecule. Whether this PrP<sup>\*</sup>-like protein is converted into PrP<sup>Sc</sup> is unclear. Although the PrP<sup>\*</sup>-like protein bound to PrP<sup>Sc</sup> is protease-resistant and insoluble, this protease-resistant PrP has not been reisolated in order to assess whether or not it was converted into PrP<sup>Sc</sup>. It is noteworthy that recombinant PrP can be refolded into either  $\alpha$ -helical or  $\beta$ -sheet forms but none have been found to possess prion infectivity as judged by bioassay [461].

### *Inherited and Sporadic Prion Diseases*

For inherited and sporadic prion diseases, the major question is how the first PrP<sup>Sc</sup> molecules are formed. Once these are formed, replication presumably follows the mechanism outlined for infectious disease. Several lines of evidence suggest that PrP<sup>Sc</sup> is more stable than PrP<sup>C</sup> and a kinetic barrier precludes the formation of PrP<sup>Sc</sup> under normal conditions. In the case of the initiation of inherited prion diseases, the barrier to PrP<sup>Sc</sup> formation must be lower for the mutant ( $\Delta$ PrP<sup>C</sup>) than the wt, and thus  $\Delta$ PrP<sup>\*</sup> can spontaneously rearrange to form  $\Delta$ PrP<sup>Sc</sup>. While the known mutations would appear to be destabilizing to the structure of PrP<sup>C</sup>, we lack useful information about the structure of the transition state for either the mutant or wt sequences. Studies of PrP in the brains of patients who were heterozygous for the E200K mutation revealed  $\Delta$ PrP<sup>Sc</sup>(E200K) molecules that were both detergent insoluble and resistant to limited proteolysis, while most wt PrP was detergent insoluble but protease sensitive [144]. These results suggest that in fCJD(E200K), insoluble wt PrP might represent a form of PrP<sup>\*</sup> [144]. In studies with CHO cells, expression of  $\Delta$ PrP(E200K) was found to be accompanied by the posttranslational acquisition of resistance to limited proteolysis [269], but such results could not be obtained when other cell lines expressing  $\Delta$ PrP(E200K) were tested, including cultured fibroblasts obtained from a patient who was homozygous for the E200K mutation [Z. Meiner *et al.*, manuscript in preparation]. It is noteworthy that levels of proteinase K used in the studies where  $\Delta$ PrP(E200K) was expressed in CHO cells were lower by a factor of 10 to 100 compared to digestions of PrP<sup>Sc</sup> derived from brain or ScN2a cells. Whether these alterations in the properties of  $\Delta$ PrP(E200K) in CHO cells provide evidence for  $\Delta$ PrP<sup>\*</sup> or such changes lie outside the pathway of  $\Delta$ PrP<sup>Sc</sup>(E200K) formation remains to be determined.

Initiation of sporadic disease may follow from a somatic mutation and thus follow a path similar to that for germline mutations in inherited disease. In this situation, the mutant PrP<sup>Sc</sup> must be capable of co-opting wt PrP<sup>C</sup>, a process known to be possible for some mutations (e.g., E200K, D178N) but less likely for others (e.g., P102L) [204,430,432]. Alternatively, the activation barrier separating wt PrP<sup>C</sup> from PrP<sup>Sc</sup> could be crossed on rare occasions when viewed in the context of a population. Most individuals would be spared while presentations in the elderly with an incidence of  $\sim 1$  per million would be seen.

### *Mechanism of Prion Propagation?*

Single user license provided by AAMI. Further copying, networking, and distribution prohibited.

From the foregoing formalism, we can ask "What is the rate-limiting step in prion

formation?" If the assembly of PrP<sup>Sc</sup> into a specific dimeric or multimeric arrangement were difficult, then a nucleation-polymerization (NP) formalism would be relevant. In NP processes, nucleation is the rate-limiting step and elongation or polymerization is facile. These conditions are frequently observed in peptide models of aggregation phenomena [226,227]. Studies with Tg mice expressing foreign PrP genes suggest, however, that a different process is operative. From investigations with mice expressing both the SHaPrP transgene and the endogenous MoPrP gene, it is clear that PrP<sup>Sc</sup> provides a template for directing prion replication [365]. Inoculation of these mice with SHaPrP<sup>Sc</sup> leads to the production of SHaPrP<sup>Sc</sup> and not MoPrP<sup>Sc</sup>. Conversely, inoculation of the Tg(SHaPrP) mice with MoPrP<sup>Sc</sup> results in MoPrP<sup>Sc</sup> formation and not SHaPrP<sup>Sc</sup>. Even stronger evidence for templating has emerged from studies of prion strains passaged in Tg(MHu2M)Prnp<sup>0/0</sup> mice expressing a chimeric Hu/MoPrP gene.

When a prion strain containing MHu2MPrP<sup>Sc</sup> derived from the brains of FFI patients is passaged in Tg(MHu2M)Prnp<sup>0/0</sup> mice, the molecular size of the protease-resistant core is 19 kD as described in more detail below. In contrast, when a prion strain containing MHu2MPrP<sup>Sc</sup> derived from the brains of fCJD(E200K) patients is passaged in Tg(MHu2M)Prnp<sup>0/0</sup> mice, the protease-resistant core is 21 kD [351,430]. Although the conformational templates were initially generated with PrP<sup>Sc</sup> molecules having different sequences, these templates are sufficient to direct replication of distinct PrP<sup>Sc</sup> molecules when the amino acid sequences of the PrPs are identical. If the formation of this template were rate-limiting, then an NP model could apply. Studies of PrP<sup>Sc</sup> formation in ScN2a cells, however, point to a distinct rate-limiting step.

Cell biologic and transgenic investigations argue for the existence of a chaperone-like molecule referred to as protein X that is required for PrP<sup>Sc</sup> formation [432]. As described below, mutagenesis experiments have created dominant negative forms of  $\Delta$ PrP<sup>C</sup> that block the formation of wt PrP<sup>Sc</sup> by binding protein X [234]. This implies that the rate-limiting step *in vivo* in prion replication must be the conversion of PrP<sup>C</sup> to PrP\* since a dominant negative derived from a single point mutation could only gate a kinetically critical step in a cellular process. In the template-directed model, the conversion of PrP<sup>C</sup> to PrP\* is a first order process. By contrast, NP processes follow higher order kinetics ( $[\text{monomer}]^m$  where  $m$  is the number of monomers in the nucleus). The experimental implications of these rate relationships are apparent in transgenic studies; if first order kinetics operate, halving the gene dose (hemizygotes) should double the incubation time while doubling the dose of a transgene array should halve the time to disease. This quantitative behavior has been observed in several studies in mice with altered levels of PrP expression [68,71,358,365]. The existence of prion strains that are conformational isoforms of PrP<sup>Sc</sup> with distinct structures, incubation times, and neurohistopathology must also be considered in an analysis of the kinetics of PrP<sup>Sc</sup> accumulation. Since the rate-limiting step in PrP<sup>Sc</sup> formation cannot involve the unique template provided by a strain, differential rates of clearance seem most likely to account for the variation in incubation times. This is consistent with the different patterns of protease sensitivity and glycosylation for distinct

prion strains [30,32,99,401,430].

We hasten to add, however, that NP models can provide a useful description of other biologic phenomena. Under conditions when the monomer is relatively rare and/or the conformational change is facile (e.g., short peptides), the NP model will dominate. When the monomer is sufficiently abundant and/or the conformational conversion is difficult to accomplish, however, the template assistance formalism provides a more likely description of the process. For yeast prions, recent data suggest that for some Sup35 concentrations, first order kinetics are seen while at lower concentrations, a sigmoid-shaped production curve consistent with an NP model is relevant [J. Weissman, unpublished data].

### *Protein X and PrP<sup>Sc</sup> Formation*

The passage of prions between species is often a stochastic process, almost always characterized by prolonged incubation times during the first passage in the new host [337]. This prolongation is often referred to as the ‘species barrier’ [337,340]. Prions synthesized *de novo* reflect the sequence of the host PrP gene and not that of the PrP<sup>Sc</sup> molecules in the inoculum derived from the donor [38]. On subsequent passage in a homologous host, the incubation time shortens to a value that remains constant for all subsequent passages. From studies with Tg mice, three factors have been identified that contribute to the species barrier: 1) the difference in PrP sequences between the prion donor and recipient, 2) the strain of prion, and 3) the species specificity of protein X, a factor defined by molecular genetic studies that binds to PrP<sup>C</sup> and facilitates PrP<sup>Sc</sup> formation. This factor is likely to be a protein, hence the provisional designation protein X [234,432]. The prion donor is the last mammal in which the prion was passaged and its PrP sequence represents the ‘species’ of the prion. The strain of prion, which seems to be enciphered in the conformation of PrP<sup>Sc</sup>, conspires with the PrP sequence, which is specified by the recipient, to determine the tertiary structure of nascent PrP<sup>Sc</sup>. These principles are demonstrated by studies on the transmission of Syrian hamster prions to mice showing that expression of a SHaPrP transgene in mice abrogated the species barrier (Table 3) [388]. Besides the PrP sequence, the strain of prion modified the transmission of SHa prions to mice (Table 3) [189,243,390].

**Table 3. Influence of Prion Species and Strains on Transmission Across a Species Barrier\***

Inoculum	Host	Incubation Time [days ± SEM] (n/n <sub>0</sub> )			
		Sc237		139H	
SHa	SHa	77 ± 1	(48/48)	167 ± 1	(94/94)
SHa	non-Tg mice	>700	(0/9)	499 ± 15	(11/11)
SHa	Tg(SHaPrP)81/FVB mice	75 ± 2	(22/22)	110 ± 2	(19/19)
SHa	Tg(SHaPrP)81/Pmp <sup>0/0</sup> mice	54 ± 1	(9/9)	65 ± 1	(15/15)

\* Data obtained from references in Reference 351.

### *Evidence for Protein X*

Protein X was postulated to explain the results on the transmission of human (Hu) prions to Tg mice (Table 4) [431,432]. Mice expressing both Mo and HuPrP were resistant to Hu prions while those expressing only HuPrP were susceptible. These results argue that MoPrP<sup>C</sup> inhibited transmission of Hu prions, i.e., the formation of nascent HuPrP<sup>Sc</sup>. In contrast to the foregoing studies, mice expressing both MoPrP and chimeric MHu2MPrP were susceptible to Hu prions, and mice expressing MHu2MPrP alone were only slightly more susceptible. These findings contend that MoPrP<sup>C</sup> has only a minimal effect on the formation of chimeric MHu2MPrP<sup>Sc</sup>.

When the data on Hu prion transmission to Tg mice were considered together, they suggested that MoPrP<sup>C</sup> prevented the conversion of HuPrP<sup>C</sup> into PrP<sup>Sc</sup> by binding to another Mo protein but had little effect on the conversion of MHu2M into PrP<sup>Sc</sup>. We interpreted these results in terms of MoPrP<sup>C</sup> binding to this Mo protein with a higher affinity than does HuPrP<sup>C</sup>. We postulated that MoPrP<sup>C</sup> had little effect on the formation of PrP<sup>Sc</sup> from MHu2M (Table 4) because MoPrP and MHu2M share the same amino acid sequence at the COOH-terminus. This also suggested that MoPrP<sup>C</sup> only weakly inhibited transmission of SHa prions to Tg(SHaPrP) mice (Table 3) because SHaPrP is more closely related to MoPrP than is HuPrP.

**Table 4. Evidence for Protein X from Transmission Studies of Human Prions\***

Inoculum	Host	MoPrP gene	Incubation Time	
			[days ± SEM]	(n/n <sub>0</sub> )
sCJD	Tg(HuPrP)	Prnp <sup>+/+</sup>	721	(1/10)
sCJD	Tg(HuPrP)Prnp <sup>0/0</sup>	Prnp <sup>0/0</sup>	263 ± 2	(6/6)
sCJD	Tg(MHu2M)	Prnp <sup>+/+</sup>	238 ± 3	(8/8)
sCJD	Tg(MHu2M)Prnp <sup>0/0</sup>	Prnp <sup>0/0</sup>	191 ± 3	(10/10)

\* Data with inoculum RG from Reference 432.

Using scrapie-infected mouse (Mo) neuroblastoma cells transfected with chimeric Hu/MoPrP genes, we extended our studies of protein X. Substitution of a Hu residue at position 214 or 218 prevented PrP<sup>Sc</sup> formation (Figure 3) [234]. The side chains of these residues protrude from the same surface of the COOH-terminal  $\alpha$ -helix forming a discontinuous epitope with residues 167 and 171 in an adjacent loop. Substitution of a basic residue at positions 167, 171, or 218 prevented PrP<sup>Sc</sup> formation; these mutant PrPs appear to act as 'dominant negatives' by binding protein X and rendering it unavailable for prion propagation. Our findings seem to explain the protective effects of basic polymorphic residues in PrP of humans and sheep [214,395,446].

## ***Is Protein X a Molecular Chaperone?***

Since PrP undergoes a profound structural transition during prion propagation, it seems likely that other proteins such as chaperones participate in this process. Whether protein X functions as a classic molecular chaperone or participates in PrP binding as part of its normal function but can also facilitate pathogenic aspects of PrP biology is unknown. Interestingly, scrapie-infected cells in culture display marked differences in the induction of heat-shock proteins [422,423], and Hsp70 mRNA has been reported to increase in scrapie of mice [237]. While attempts to isolate specific proteins that bind to PrP have been disappointing [324], PrP has been shown to interact with Bcl-2 and Hsp60 by two-hybrid analysis in yeast [128,259]. Weiss and coworkers have used a similar approach to show that PrP binds the laminin receptor protein [442]. Although these studies are suggestive, no molecular chaperone involved in prion formation in mammalian cells has been identified.

# Strains of Prions

The existence of prion strains raises the question of how heritable biological information can be enciphered in a molecule other than nucleic acid [63,119,120,239,240,374,444]. Strains or varieties of prions have been defined by incubation times and the distribution of neuronal vacuolation [119,137]. Subsequently, the patterns of PrP<sup>Sc</sup> deposition were found to correlate with vacuolation profiles and these patterns were also used to characterize strains of prions [62,111,116,189].

The typing of prion strains in C57Bl, VM, and F1(C57Bl × VM) inbred mice began with isolates from sheep with scrapie. The prototypic strains called Me7 and 22A gave incubation times of ~150 and ~400 days in C57Bl mice, respectively [60,118,119]. The PrPs of C57Bl and I/Ln (and later VM) mice differ at two residues and control incubation times [71-73,216,313,445].

Until recently, support for the hypothesis that the tertiary structure of PrP<sup>Sc</sup> enciphers strain-specific information [350] was minimal except for the DY strain isolated from mink with transmissible encephalopathy [29,31,32]. PrP<sup>Sc</sup> in DY prions showed diminished resistance to proteinase K digestion as well as an anomalous site of cleavage. The DY strain presented a puzzling anomaly since other prion strains exhibiting similar incubation times did not show this altered susceptibility to proteinase K digestion of PrP<sup>Sc</sup> [390]. Also notable was the generation of new strains during passage of prions through animals with different PrP genes [243,390].

## *PrP<sup>Sc</sup> Conformation Enciphers Variation in Prions*

Persuasive evidence that strain-specific information is enciphered in the tertiary structure of PrP<sup>Sc</sup> comes from transmission of two different inherited human prion diseases to mice expressing a chimeric MHu2MPrP transgene [430]. In fatal familial insomnia, the protease-resistant fragment of PrP<sup>Sc</sup> after deglycosylation has an M<sub>r</sub> of 19 kD; whereas in fCJD(E200K) and most sporadic prion diseases, it is 21 kD (Table 5) [312,334]. This difference in molecular size was shown to be due to different sites of proteolytic cleavage at the NH<sub>2</sub>-termini of the two human PrP<sup>Sc</sup> molecules reflecting different tertiary structures [312]. These distinct conformations were not unexpected since the amino acid sequences of the PrPs differ.

Extracts from the brains of FFI patients transmitted disease into mice expressing a chimeric MHu2MPrP gene about 200 days after inoculation and induced formation of the 19-kD PrP<sup>Sc</sup>; whereas fCJD(E200K) and sCJD produced the 21-kD PrP<sup>Sc</sup> in mice expressing the same transgene [430]. On second passage, Tg(MHu2M) mice inoculated with FFI prions showed an incubation time of ~130 days and a 19-kD PrP<sup>Sc</sup> while those inoculated with fCJD(E200K) prions exhibited an incubation time of ~170 days and a 21-kD PrP<sup>Sc</sup> [351]. The experimental data demonstrate that MHu2MPrP<sup>Sc</sup> can exist in two different conformations based on the sizes of the protease-resistant fragments; yet, the amino acid sequence of MHu2MPrP<sup>Sc</sup> is invariant.



The results of our studies argue that PrP<sup>Sc</sup> acts as a template for the conversion of PrP<sup>C</sup> into nascent PrP<sup>Sc</sup>. Imparting the size of the protease-resistant fragment of PrP<sup>Sc</sup> through conformational templating provides a mechanism for both the generation and propagation of prion strains.

Interestingly, the protease-resistant fragment of PrP<sup>Sc</sup> after deglycosylation with an M<sub>r</sub> of 19 kD has been found in a patient who died after developing a clinical disease similar to FFI. Since both PrP alleles encoded the wt sequence and a Met at position 129, we labeled this case fatal sporadic insomnia (FSI). At autopsy, the spongiform degeneration, reactive astrogliosis, and PrP<sup>Sc</sup> deposition were confined to the thalamus [291]. These findings argue that the clinicopathologic phenotype is determined by the conformation of PrP<sup>Sc</sup> in accord with the results of the transmission of human prions from patients with FFI to Tg mice [430].

**Table 5. Distinct Prion Strains Generated in Humans with Inherited Prion Diseases and Transmitted to Transgenic Mice\***

Inoculum	Host Species	Host PrP Genotype	Incubation time		PrP <sup>Sc</sup> (kD)
			[days ± SEM]	(n/n <sub>0</sub> )	
None	Human	FFI(D178N,M129)			19
FFI	Mouse	Tg(MHu2M)	206 ± 7	(7/7)	19
FFI→Tg(MHu2M)	Mouse	Tg(MHu2M)	136 ± 1	(6/6)	19
None	Human	fCJD(E200K)			21
fCJD	Mouse	Tg(MHu2M)	170 ± 2	(10/10)	21
fCJD→Tg(MHu2M)	Mouse	Tg(MHu2M)	167 ± 3	(15/15)	21

\*Data obtained from References 351 and 430.

# Therapeutic Approaches to Prion Diseases

It seems likely that it will be possible to design effective therapeutics for prion diseases as our understanding of prion propagation increases. Because people at risk for inherited prion diseases can now be identified decades before neurologic dysfunction is evident, the development of an effective therapy for these fully penetrant disorders is imperative [85,402]. Although we have no way of predicting the number of individuals who may develop neurologic dysfunction from bovine prions in the future [103], seeking an effective therapy now seems prudent [1,351]. Interfering with the conversion of PrP<sup>C</sup> into PrP<sup>Sc</sup> seems to be the most attractive therapeutic target [96]. Either stabilizing the structure of PrP<sup>C</sup> via the formation of a PrP<sup>C</sup>-drug complex or modifying the action of protein X, which might function as a molecular chaperone (Figure 3), are reasonable strategies. Whether it is more efficacious to design a drug that binds to PrP<sup>C</sup> at the protein X binding site or one that mimics the structure of PrP<sup>C</sup> with basic polymorphic residues that seem to prevent scrapie and CJD remains to be determined [234,395]. Since PrP<sup>Sc</sup> formation seems limited to caveolae-like domains [180,232,315,411,438], drugs designed to inhibit this process need not penetrate the cytosol of cells but they do need to be able to enter the CNS. Alternatively, drugs that destabilize the structure of PrP<sup>Sc</sup> might also prove useful.

The production of domestic animals that do not replicate prions may also be important with respect to preventing prion disease. Sheep encoding the R/R polymorphism at position 171 seem to be resistant to scrapie [22,94,175,211,214,217,219,322,446]; presumably, this was the genetic basis of Parry's scrapie eradication program in Great Britain 30 years ago [335,336]. A more effective approach using dominant negatives for producing prion-resistant domestic animals, including sheep and cattle, is probably the expression of PrP transgenes encoding R171 as well as additional basic residues at the protein X binding site (Figure 3) [234]. Such an approach can be readily evaluated in Tg mice and once shown to be effective, it could be instituted by artificial insemination of sperm from males homozygous for the transgene. Less practical is the production of PrP-deficient cattle and sheep. Although such animals would not be susceptible to prion disease [66,358], they might suffer some deleterious effects from ablation of the PrP gene [100,271,384,436].

Whether gene therapy for the human prion diseases will prove feasible using the dominant negative approach described above for prion-resistant animals depends on the availability of efficient vectors for delivery of the transgene to the CNS.

# Prions are Unprecedented

Although the study of prions has taken several unexpected directions over the past three decades, a novel and fascinating story of prion biology is emerging. Investigations of prions have elucidated a previously unknown mechanism of disease in humans and animals. While learning the details of the structures of PrPs and deciphering the mechanism of PrP<sup>C</sup> transformation into PrP<sup>Sc</sup> will be important, the fundamental principles of prion biology have become reasonably clear. Though some investigators prefer to view the composition of the infectious prion particle as unresolved [1,88], such a perspective denies an enlarging body of data, none of which refutes the prion concept. Moreover, the discovery of prion-like phenomena mediated by proteins unrelated to PrP in yeast and other fungi serve not only to strengthen the prion concept but also to widen it [447].

The discovery that prion diseases in humans are uniquely both genetic and infectious greatly strengthened and extended the prion concept. To date, 20 different mutations in the human PrP gene, all resulting in nonconservative substitutions, have been found either to be linked genetically to, or to segregate with, the inherited prion diseases (Figure 1). Yet, the transmissible prion particle is composed largely, if not exclusively, of an abnormal isoform of the prion protein designated PrP<sup>Sc</sup> [350].

## *Aberrant PrP Metabolism*

The hallmark of all prion diseases — whether sporadic, dominantly inherited, or acquired by infection — is that they involve the aberrant metabolism and resulting accumulation of the prion protein (Table 1) [350]. The conversion of PrP<sup>C</sup> into PrP<sup>Sc</sup> involves a conformation change whereby the  $\alpha$ -helical content diminishes and the amount of  $\beta$ -sheet increases [332]. These findings provide a reasonable mechanism to explain the conundrum presented by the three different manifestations of prion disease.

Understanding how PrP<sup>C</sup> unfolds and refolds into PrP<sup>Sc</sup> will be of paramount importance in transferring advances in the prion diseases to studies of other degenerative illnesses. The mechanism by which PrP<sup>Sc</sup> is formed must involve a templating process whereby existing PrP<sup>Sc</sup> directs the refolding of PrP<sup>C</sup> into a nascent PrP<sup>Sc</sup> with the same conformation. Not only will a knowledge of PrP<sup>Sc</sup> formation help in the rational design of drugs that interrupt the pathogenesis of prion diseases, but it may also open new approaches to deciphering the causes of, and to developing effective therapies for, the more common neurodegenerative diseases including Alzheimer's disease, Parkinson's disease, and amyotrophic lateral sclerosis. Indeed, the expanding list of prion diseases and their novel modes of transmission and pathogenesis (Table 1), as well as the unprecedented mechanisms of prion propagation and information transfer (Table 5), indicate that much more attention to these fatal disorders of protein conformation is urgently needed.

Prions may have even wider implications than those noted for the common neurodegenerative diseases. If we think of prion diseases as disorders of protein conformation and do not require the diseases to be transmissible, then what we have

learned from the study of prions may reach far beyond these common illnesses.

### *Conformational Diversity*

The discovery that proteins may have multiple biologically-active conformations may prove no less important than the implications of prions for diseases. How many different tertiary structures can PrP<sup>Sc</sup> adopt? This query not only addresses the issue of the limits of prion diversity but also applies to proteins as they normally function within the cell or act to affect homeostasis in multicellular organisms. The expanding list of chaperones that assist the folding and unfolding of proteins promises much new knowledge about this process. For example, it is now clear that proproteases can carry their own chaperone activity where the *pro* portion of the protein functions as a chaperone in *cis* to guide the folding of the proteolytically active portion before it is cleaved [396]. Such a mechanism might well feature in the maturation of polypeptide hormones. Interestingly, mutation of the chaperone portion of prosubtilisin resulted in the folding of a subtilisin protease with different properties than the one folded by the wt chaperone. Such chaperones have also been shown to work in *trans* [396]. Besides transient metabolic regulation within the cell and hormonal regulation of multicellular organisms, it is not unreasonable to suggest that assembly of proteins into multimeric structures such as intermediate filaments might be controlled at least in part by alternative conformations of proteins. Such regulation of multimeric protein assemblies might occur either in the proteins that form the multimers or the proteins that function to facilitate the assembly process. Additionally, apoptosis during development and throughout adult life might also be regulated, at least in part by alternative tertiary structures of proteins.

### *Future Studies*

The wealth of data establishing the essential role of PrP in the transmission of prions and the pathogenesis of prion diseases has provoked consideration of how many biological processes are controlled by changes in protein conformation. The extreme radiation-resistance of scrapie infectivity suggested that the pathogen causing this disease and related illnesses would be different from viruses, viroids, and bacteria [2,3]. Indeed, an unprecedented mechanism of disease has been revealed where an aberrant conformational change in a protein is propagated. The future of this emerging area of biology should prove even more interesting and productive as many new discoveries emerge.

# Acknowledgment

I am indebted to F. Cohen, S. DeArmond, and M. Scott for their help in summarizing these studies. This research was supported by grants from the National Institute of Aging and the National Institute of Neurologic Diseases and Stroke of the National Institutes of Health, the National Science Foundation, International Human Frontiers of Science Program, and the American Health Assistance Foundation as well as by gifts from the Sherman Fairchild Foundation, the Keck Foundation, the G. Harold and Leila Y. Mathers Foundation, the Bernard Osher Foundation, the John D. French Foundation, the Howard Hughes Medical Institute, R. J. Reynolds, National Medical Enterprises, and Centeon.

# References

1. Aguzzi A, Weissmann C. Prion research: the next frontiers. *Nature* 1997;389:795-8.
2. Alper T, Cramp WA, Haig DA, Clarke MC. Does the agent of scrapie replicate without nucleic acid? *Nature* 1967;214:764-6.
3. Alper T, Haig DA, Clarke MC. The exceptionally small size of the scrapie agent. *Biochem Biophys Res Commun* 1966;22:278-84.
4. Alper T, Haig DA, Clarke MC. The scrapie agent: Evidence against its dependence for replication on intrinsic nucleic acid. *J Gen Virol* 1978;41:503-16.
5. Alpers M. Kuru: a clinical study. In: Mimeographed Manuscript, Reissued. Bethesda: U.S.D.H.E.W., N.I.H., N.I.N.C.D.S.; 1964. p. 1-38.
6. Alpers M. Epidemiology and clinical aspects of kuru. In: Prusiner SB, McKinley MP, editors. *Prions - Novel Infectious Pathogens Causing Scrapie and Creutzfeldt-Jakob Disease*. Orlando: Academic Press; 1987. p. 451-65.
7. Alpers MP. Epidemiology and ecology of kuru. In: Prusiner SB, Hadlow WJ, editors. *Slow Transmissible Diseases of the Nervous System, Vol. 1*. New York: Academic Press; 1979. p. 67-90.
8. Alter M, Kahana E. Creutzfeldt-Jakob disease among Libyan Jews in Israel. *Science* 1976;192:428.
9. Anderson JR, Allen CMC, Weller RO. Creutzfeldt-Jakob disease following human pituitary-derived growth hormone administration. *Br Neuropathol Soc Proc* 1990;16:543.
10. Anderson RM, Donnelly CA, Ferguson NM, et al. Transmission dynamics and epidemiology of BSE in British cattle. *Nature* 1996;382:779-88.
11. Arens W. *The Man-Eating Myth: Anthropology & Anthrophagy*. New York: Oxford University Press; 1979. p. 206.
12. Au WJ, Gabor AJ, Vijayan N, Markand ON. Periodic lateralized epileptiform complexes (PLEDs) in Creutzfeldt-Jakob disease. *Neurology* 1980;30:611-7.
13. Austin J, Sakai M. Disorder of glycogen and related molecules in the nervous system. In: Vinken PJ, Bruyn GW, editors. *Handbook of Clinical Neurology, Vol. 27*. New York: American Elsevier; 1976. p. 169-219.
14. Azzarelli B, Muller J, Ghetti B, Dyken M, Conneally PM. Cerebellar plaques in familial Alzheimer's disease (Gerstmann-Sträussler-Scheinker variant?). *Acta Neuropathol (Berl)* 1985;65:235-46.
15. Baker HF, Ridley RM, Crow TJ. Experimental transmission of an autosomal dominant spongiform encephalopathy: Does the infectious agent originate in the human genome? *Br Med J* 1985;291:299-302.
16. Baker HF, Ridley RM, Wells GAH. Experimental transmission of BSE and scrapie to the common marmoset. *Vet Rec* 1993;132:403-6.
17. Bateman D, Hilton D, Love S, Zeidler M, Beck J, Collinge J. Sporadic Creutzfeldt-Jakob disease in a 18-year-old in the UK [letter]. *Lancet* 1995;346:1155-6.
18. Beck E, Daniel PM. Kuru and Creutzfeldt-Jakob disease; neuropathological lesions and their significance. In: Prusiner SB, Hadlow WJ, editors. *Slow Transmissible*

- Diseases of the Nervous System, Vol. 1. New York: Academic Press. 1979; p. 253-70.
19. Beck E, Daniel PM, Davey AJ, Gajdusek DC, Gibbs CJ Jr. The pathogenesis of transmissible spongiform encephalopathy – an ultrastructural study. *Brain* 1982;105:755-86.
  20. Beck E, Daniel PM, Parry HB. Degeneration of the cerebellar and hypothalamo-neurohypophysial systems in sheep with scrapie; and its relationship to human system degenerations. *Brain* 1964;87:153-76.
  21. Bellinger-Kawahara CG, Kempner E, Groth DF, Gabizon R, Prusiner SB. Scrapie prion liposomes and rods exhibit target sizes of 55,000 Da. *Virology* 1988;164:537-41.
  22. Belt PBGM, Muileman IH, Schreuder BEC, Ruijter JB, Gielkens ALJ, Smits MA. Identification of five allelic variants of the sheep PrP gene and their association with natural scrapie. *J Gen Virol* 1995;76:509-17.
  23. Bendheim PE, Bockman JM, McKinley MP, Kingsbury DT, Prusiner SB. Scrapie and Creutzfeldt-Jakob disease prion proteins share physical properties and antigenic determinants. *Proc Natl Acad Sci USA* 1985;82:997-1001.
  24. Benson DF. Neuroimaging and dementia. *Neurol Clin* 1986;4:341-53.
  25. Bernouilli C, Siegfried J, Baumgartner G, et al. Danger of accidental person to person transmission of Creutzfeldt-Jakob disease by surgery. *Lancet* 1977;1:478-9.
  26. Bernouilli CC, Masters CL, Gajdusek DC, Gibbs CJ Jr, Harris JO. Early clinical features of Creutzfeldt-Jakob disease (subacute spongiform encephalopathy). In: Prusiner SB and Hadlow WJ, editors. *Slow Transmissible Diseases of the Nervous System, Vol. 1*. New York: Academic Press; 1979. p. 229-51.
  27. Bertoni JM, Brown P, Goldfarb L, Gajdusek D, Omaha NE. Familial Creutzfeldt-Jakob disease with the PRNP codon 200lys mutation and supranuclear palsy but without myoclonus or periodic EEG complexes [abstract]. *Neurology* 1992;42(4 Suppl 3):350.
  28. Bertoni JM, Label LS, Sackelleres JC, Hicks SP. Supranuclear gaze palsy in familial Creutzfeldt-Jakob disease. *Arch Neurol* 1983;40:618-22.
  29. Bessen RA, Kocisko DA, Raymond GJ, Nandan S, Lansbury PT, Caughey B. Non-genetic propagation of strain-specific properties of scrapie prion protein. *Nature* 1995;375:698-700.
  30. Bessen RA, Marsh RF. Biochemical and physical properties of the prion protein from two strains of the transmissible mink encephalopathy agent. *J Virol* 1992;66:2096-101.
  31. Bessen RA, Marsh RF. Identification of two biologically distinct strains of transmissible mink encephalopathy in hamsters. *J Gen Virol* 1992;73:329-34.
  32. Bessen RA, Marsh RF. Distinct PrP properties suggest the molecular basis of strain variation in transmissible mink encephalopathy. *J Virol* 1994;68:7859-68.
  33. Billette de Villemeur T, Beauvais P, Gourmelon M, Richardet JM. Creutzfeldt-Jakob disease in children treated with growth hormone. *Lancet* 1991;337:864-5.
  34. Billette de Villemeur T, Deslys J-P, Pradel A, et al. Creutzfeldt-Jakob disease from contaminated growth hormone extracts in France. *Neurology* 1996;47:690-5.
  35. Blackwood W, McMenemy WH, Meyer A, Norman RM, Russell DS. *Greenfield's Neuropathology*, 2nd ed. London: Edward Arnold; 1971. p. 558-67.
  36. Bobowick AR, Brody JA, Matthews MR, Roos R, Gajdusek DC. Creutzfeldt-Jakob

- disease: a case-control study. *Am J Epidemiol* 1973;98:381-94.
37. Bockman JM, Kingsbury DT, McKinley MP, Bendheim PE, Prusiner SB. Creutzfeldt-Jakob disease prion proteins in human brains. *N Engl J Med* 1985;312:73-8.
  38. Bockman JM, Prusiner SB, Tateishi J, Kingsbury DT. Immunoblotting of Creutzfeldt-Jakob disease prion proteins: host species-specific epitopes. *Ann Neurol* 1987;21:589-95.
  39. Bolton DC, McKinley MP, Prusiner SB. Identification of a protein that purifies with the scrapie prion. *Science* 1982;218:1309-11.
  40. Bolton DC, Meyer RK, Prusiner SB. Scrapie PrP 27-30 is a sialoglycoprotein. *J Virol* 1985;53:596-606.
  41. Bonduelle M, Escourolle R, Bouygues P, Lormeau G, Ribadeau Dumas JL, Merland JJ. Maladie de Creutzfeldt-Jakob familiale. Observation anatomo-clinique [Familial Creutzfeldt-Jakob disease. Anatomoclinical case]. *Rev Neurol (Paris)* 1971;125:197-209.
  42. Borchelt DR, Scott M, Taraboulos A, Stahl N, Prusiner SB. Scrapie and cellular prion proteins differ in their kinetics of synthesis and topology in cultured cells. *J Cell Biol* 1990;110:743-52.
  43. Borchelt DR, Taraboulos A, Prusiner SB. Evidence for synthesis of scrapie prion proteins in the endocytic pathway. *J Biol Chem* 1992;267:16188-99.
  44. Braham J. Jakob-Creutzfeldt disease: Treatment by amantadine. *Br Med J* 1971;4:212-3.
  45. Britton TC, Al-Sarraj S, Shaw C, Campbell T, Collinge J. Sporadic Creutzfeldt-Jakob disease in a 16-year-old in the UK [letter]. *Lancet* 1995;346:1155.
  46. Brown P. An epidemiologic critique of Creutzfeldt-Jakob disease. *Epidemiol Rev* 1980;2:113-35.
  47. Brown P. Virus sterility for human growth hormone. *Lancet* 1985;2:729-30.
  48. Brown P, Cathala F, Raubertas RF, Gajdusek DC, Castaigne P. The epidemiology of Creutzfeldt-Jakob disease: conclusion of 15-year investigation in France and review of the world literature. *Neurology* 1987;37:895-904.
  49. Brown P, Cathala F, Sadowsky D, Gajdusek DC. Creutzfeldt-Jakob disease in France: II. Clinical characteristics of 124 verified cases during the decade 1968-1977. *Ann Neurol* 1979;6:430-7.
  50. Brown P, Coker-Vann M, Gajdusek DC. Immunological study of patients with Creutzfeldt-Jakob disease and other chronic neurological disorders: Western blot recognition of infection-specific proteins by scrapie virus antibody. In: Bignami A, Bolis CL, Gajdusek DC, editors. *Molecular Mechanisms of Pathogenesis of Central Nervous System Disorders*. Geneva: Foundation for the Study of the Nervous System; 1986. p. 107-9.
  51. Brown P, Coker-Vann M, Pomeroy K, et al. Diagnosis of Creutzfeldt-Jakob disease by Western blot identification of marker protein in human brain tissue. *N Engl J Med* 1986;314:547-51.
  52. Brown P, Gibbs CJ Jr, Amyx HL, Kingsbury DT, Rohwer RG, Sulima MP, et al. Chemical disinfection of Creutzfeldt-Jakob disease virus. *N Engl J Med* 1982;306:1279-



53. Brown P, Gibbs CJ Jr, Rodgers-Johnson P, et al. Human spongiform encephalopathy: The National Institutes of Health series of 300 cases of experimentally transmitted disease. *Ann Neurol* 1994;35:513-29.
54. Brown P, Preece MA, Will RG. "Friendly fire" in medicine: Hormones, homografts, and Creutzfeldt-Jakob disease. *Lancet* 1992;340:24-7.
55. Brown P, Rodgers-Johnson P, Cathala F, Gibbs CJ Jr, Gajdusek DC. Creutzfeldt-Jakob disease of long duration: Clinicopathological characteristics, transmissibility, and differential diagnosis. *Ann Neurol* 1984;16:295-304.
56. Brown P, Rohwer RG, Gajdusek DC. Sodium hydroxide decontamination of Creutzfeldt-Jakob disease virus. *N Engl J Med* 1984;310:727.
57. Brown P, Rohwer RG, Green EM, Gajdusek DC. Effect of chemicals, heat, and histopathologic processing on high-infectivity hamster-adapted scrapie virus. *J Infect Dis* 1982;145:683-7.
58. Brownell B, Oppenheimer, DR. An ataxic form of subacute presenile poliоencephalopathy (Creutzfeldt-Jakob disease). *J Neurol Neurosurg Psychiat* 1965;28:350-61.
59. Bruce M, Chree A, McConnell I, Foster J, Fraser H. Transmissions of BSE, scrapie and related diseases to mice [abstract]. *Proceedings of the IXth International Congress of Virology*; 1993. p. 93.
60. Bruce ME, Dickinson AG. Biological evidence that the scrapie agent has an independent genome. *J Gen Virol* 1987;68:79-89.
61. Bruce ME, Fraser H. Amyloid plaques in the brains of mice infected with scrapie: morphological variation and staining properties. *Neuropathol Appl Neurobiol* 1975;1:189-202.
62. Bruce ME, McBride PA, Farquhar CF. Precise targeting of the pathology of the sialoglycoprotein, PrP, and vacuolar degeneration in mouse scrapie. *Neurosci Lett* 1989;102:1-6.
63. Bruce ME, McConnell I, Fraser H, Dickinson AG. The disease characteristics of different strains of scrapie in *Sinc* congenic mouse lines: Implications for the nature of the agent and host control of pathogenesis. *J Gen Virol* 1991;72:595-603.
64. Bruce ME, Will RG, Ironside JW, et al. Transmissions to mice indicate that 'new variant' CJD is caused by the BSE agent. *Nature* 1997;389:498-501.
65. Buchanan CR, Preece MA, Milner RDG. Mortality, neoplasia and Creutzfeldt-Jakob disease in patients treated with pituitary growth hormone in the United Kingdom. *Br Med J* 1991;302:824-8.
66. Büeler H, Aguzzi A, Sailer A, et al. Mice devoid of PrP are resistant to scrapie. *Cell* 1993;73:1339-47.
67. Büeler H, Fischer M, Lang Y, et al. Normal development and behaviour of mice lacking the neuronal cell-surface PrP protein. *Nature* 1992;356:577-82.
68. Büeler H, Raeber A, Sailer A, Fischer M, Aguzzi A, Weissmann C. High prion and PrP<sup>Sc</sup> levels but delayed onset of disease in scrapie-inoculated mice heterozygous for a disrupted PrP gene. *Mol Med* 1994;1:19-30.

69. Burger LJ, Rowan AJ, Goldensohn ES. Creutzfeldt-Jakob disease. An electroencephalographic study. *Arch Neurol* 1972;26:428-33.
70. Buyukmihci N, Rorvik M, Marsh RF. Replication of the scrapie agent in ocular neural tissues. *Proc Natl Acad Sci USA* 1980;77:1169-71.
71. Carlson GA, Ebeling C, Yang S-L, et al. Prion isolate specified allotypic interactions between the cellular and scrapie prion proteins in congenic and transgenic mice. *Proc Natl Acad Sci USA* 1994;91:5690-4.
72. Carlson GA, Goodman PA, Lovett M, et al. Genetics and polymorphism of the mouse prion gene complex: The control of scrapie incubation time. *Mol Cell Biol* 1988;8:5528-40.
73. Carlson GA, Kingsbury DT, Goodman PA, et al. Linkage of prion protein and scrapie incubation time genes. *Cell* 1986;46:503-11.
74. Carp RI, Meeker H, Sersen E. Scrapie strains retain their distinctive characteristics following passages of homogenates from different brain regions and spleen. *J Gen Virol* 1997;78:283-90.
75. Casaccia P, Ladogana A, Xi YG, et al. Measurement of the concentration of amphotericin B in brain tissue of scrapie-infected hamsters with a simple and sensitive method. *Antimicrob Agents Chemother* 1991;35:1486-88.
76. Castleman B, Richardson EPJ. *Neurologic Clinicopathologic Conferences of the Massachusetts General Hospital*. London: Churchill; 1968.
77. Cathala F, Baron H. Clinical aspects of Creutzfeldt-Jakob disease. In: Prusiner SB, McKinley MP, editors. *Prions – Novel Infectious Pathogens Causing Scrapie and Creutzfeldt-Jakob Disease*. Orlando: Academic Press; 1987. p. 467-509.
78. Caughey B, Chesebro B. Prion protein and the transmissible spongiform encephalopathies. *Trends Cell Biol* 1997;7:56-62.
79. Caughey B, Kocisko DA, Raymond GJ, Lansbury PT Jr. Aggregates of scrapie-associated prion protein induce the cell-free conversion of protease-sensitive prion protein to the protease-resistant state. *Chem Biol* 1995;2:807-17.
80. Caughey B, Raymond, GJ. The scrapie-associated form of PrP is made from a cell surface precursor that is both protease- and phospholipase-sensitive. *J Biol Chem* 1991;266:18217-223.
81. CDC. Surveillance for Creutzfeldt-Jakob disease – United States. *MMWR Morb Mortal Wkly Rep* 1996;45:665-8.
82. CDC. Creutzfeldt-Jakob disease associated with cadaveric dura mater grafts – Japan, January 1979-May 1996. *MMWR Morb Mortal Wkly Rep* 1997;46:1066-9.
83. Cervenáková L, Brown P, Piccardo P, et al. 24-nucleotide deletion in the *PRNP* gene: Analysis of associated phenotypes. In: Court L, Dodet B, editors. *Transmissible Subacute Spongiform Encephalopathies: Prion Diseases*. Paris: Elsevier; 1996. p. 433-44.
84. Chandler RL. Encephalopathy in mice produced by inoculation with scrapie brain material. *Lancet* 1961;1:1378-9.
85. Chapman J, Ben-Israel J, Goldhammer Y, Korczyn AD. The risk of developing Creutzfeldt-Jakob disease in subjects with the *PRNP* gene codon 200 point mutation.

Neurology 1994;44:1683-6.

86. Chatigny MA, Prusiner SB. Biohazards of investigations on the transmissible spongiform encephalopathies. *Rev Infect Dis* 1980;2:713-24.
87. Chazot G, Broussolle E, Lapras CI, Blättler T, Aguzzi A, Kopp N. New variant of Creutzfeldt-Jakob disease in a 26-year-old French man. *Lancet* 1996;347:1181.
88. Chesebro B. Prion diseases: BSE and prions: Uncertainties about the agent. *Science* 1998;279:42-3.
89. Chesebro B, Race R, Wehrly K, et al. Identification of scrapie prion protein-specific mRNA in scrapie-infected and uninfected brain. *Nature* 1985;315:331-3.
90. Chiafalo N, Fuentes AN, Galvez S. Serial EEG findings in 27 cases of Creutzfeldt-Jakob disease. *Arch Neurol* 1980;37:143-5.
91. Chou SM, Martin JD. Kuru-plaques in a case of Creutzfeldt-Jakob disease. *Acta Neuropathol (Berl)* 1971;17:150-5.
92. Chou SM, Payne WN, Gibbs CJ Jr, Gajdusek DC. Transmission and scanning electron microscopy of spongiform change in Creutzfeldt-Jakob disease. *Brain* 1980;103:885-904.
93. Clavel M, Clavel P. Creutzfeldt-Jakob disease transmitted by dura mater graft. *Eur Neurol* 1996;36:239-40.
94. Clousard C, Beaudry P, Elsen JM, et al. Different allelic effects of the codons 136 and 171 of the prion protein gene in sheep with natural scrapie. *J Gen Virol* 1995;76:2097-101.
95. Cochius JI, Mack K, Burns RJ, Alderman CP, Blumbergs PC. Creutzfeldt-Jakob disease in a recipient of human pituitary-derived gonadotrophin. *Aust N Z J Med* 1990;20:592-3.
96. Cohen FE, Pan K-M, Huang Z, Baldwin M, Fletterick RJ, Prusiner SB. Structural clues to prion replication. *Science* 1994;264:530-1.
97. Collinge J, Palmer MS, Dryden AJ. Genetic predisposition to iatrogenic Creutzfeldt-Jakob disease. *Lancet* 1991;337:1441-2.
98. Collinge J, Palmer MS, Sidle KC, et al. Unaltered susceptibility to BSE in transgenic mice expressing human prion protein. *Nature* 1995;378:779-83.
99. Collinge J, Sidle KCL, Meads J, Ironside J, Hill AF. Molecular analysis of prion strain variation and the etiology of "new variant" CJD. *Nature* 1996;383:685-90.
100. Collinge J, Whittington MA, Sidle KC, et al. Prion protein is necessary for normal synaptic function. *Nature* 1994;370:295-7.
101. Committee PIC. Report on Human Growth Hormone and Creutzfeldt-Jakob Disease. 1997.
102. Cousens SN, Harries-Jones R, Knight R, Will RG, Smith PG, Matthews WB. Geographical distribution of cases of Creutzfeldt-Jakob disease in England and Wales 1970-84. *J Neurol Neurosurg Psychiatry* 1990;53:459-65.
103. Cousens SN, Vynnycky E, Zeidler M, Will RG, Smith PG. Predicting the CJD epidemic in humans. *Nature* 1997;385:197-8.
104. Creutzfeldt HG. Über eine eigenartige herdförmige Erkrankung des Zentralnervensystems. *Z Gesamte Neurol Psychiatrie* 1920;57:1-18.

105. Croxson M, Brown P, Synek B, et al. A new case of Creutzfeldt-Jakob disease associated with human growth hormone therapy in New Zealand. *Neurology* 1988;38:1128-30.
106. Cuillé J, Chelle PL. Experimental transmission of trembling to the goat. *CR Seances Acad Sci* 1939;208:1058-60.
107. Davanipour Z, Goodman L, Alter M, Sobel E, Asher D, Gajdusek DC. Possible modes of transmission of Creutzfeldt-Jakob disease. *N Engl J Med* 1984;311:1582-3.
108. Dawson M, Wells GAH, Parker BNJ. Preliminary evidence of the experimental transmissibility of bovine spongiform encephalopathy to cattle. *Vet Rec* 1990;126:112-3.
109. Dawson M, Wells GAH, Parker BNJ, Scott AC. Primary parenteral transmission of bovine spongiform encephalopathy to the pig. *Vet Rec* 1990;127:338.
110. DeArmond SJ, Kretzschmar HA, McKinley MP, Prusiner SB. Molecular pathology of prion diseases. In: Prusiner SB, McKinley MP, editors. *Prions - Novel Infectious Pathogens Causing Scrapie and Creutzfeldt-Jakob Disease*. Orlando: Academic Press; 1987. p. 387-414.
111. DeArmond SJ, Mobley WC, DeMott DL, Barry RA, Beckstead JH, Prusiner SB. Changes in the localization of brain prion proteins during scrapie infection. *Neurology* 1987;37:1271-80.
112. DeArmond SJ, Prusiner SB. Etiology and pathogenesis of prion diseases. *Am J Path* 1995;146:785-811.
113. DeArmond SJ, Prusiner SB. Molecular neuropathology of prion diseases. In: Rosenberg RN, Prusiner SB, DiMauro S, Barchi RL, editors. *The Molecular and Genetic Basis of Neurological Disease*. 2nd ed. Stoneham (MA): Butterworth Heinemann; 1997. p. 145-63.
114. DeArmond SJ, Prusiner SB. Prion diseases. In: Lantos P, Graham D, editors. *Greenfield's Neuropathology*. 6th ed. London: Edward Arnold; 1997. p. 235-80.
115. DeArmond SJ, Sánchez H, Yehiely F, et al. Selective neuronal targeting in prion disease. *Neuron* 1997;19:1337-48.
116. DeArmond SJ, Yang S-L, Lee A, et al. Three scrapie prion isolates exhibit different accumulation patterns of the prion protein scrapie isoform. *Proc Natl Acad Sci USA* 1993;90:6449-53.
117. Dickinson AG, Fraser H, Outram GW. Scrapie incubation time can exceed natural lifespan. *Nature* 1975;256:732-3.
118. Dickinson AG, Meikle VM. A comparison of some biological characteristics of the mouse-passaged scrapie agents, 22A and ME7. *Genet Res* 1969;13:213-25.
119. Dickinson AG, Meikle VMH, Fraser H. Identification of a gene which controls the incubation period of some strains of scrapie agent in mice. *J Comp Pathol* 1968;78:293-9.
120. Dickinson AG, Outram GW. Genetic aspects of unconventional virus infections: The basis of the virino hypothesis. In: Bock G, Marsh J, editors. *Novel Infectious Agents and the Central Nervous System*. Ciba Foundation Symposium 135. Chichester (UK): John Wiley and Sons; 1988. p. 63-83.
121. Dickinson AG, Young GB, Stamp JT, Renwick CC. An analysis of natural scrapie in

Suffolk sheep. *Heredity* 1965;20:485-503.

122. Dlouhy SR, Hsiao K, Farlow MR, et al. Linkage of the Indiana kindred of Gerstmann-Sträussler-Scheinker disease to the prion protein gene. *Nat Genet* 1992;1:64-7.
123. Doh-ura K, Kitamoto T, Sakaki Y, Tateishi J. CJD discrepancy. *Nature* 1991;353:801-2.
124. Doh-ura K, Tateishi J, Sasaki H, Kitamoto T, Sakaki Y. Pro >Leu change at position 102 of prion protein is the most common but not the sole mutation related to Gerstmann-Sträussler syndrome. *Biochem Biophys Res Commun* 1989;163:974-9.
125. Dolman CL, Daly LL. Spino-cerebello-cerebral degeneration with amyloid plaques (Gerstmann, Sträussler, Scheinker syndrome). *Can J Neurol Sci* 1982;9:439-42.
126. Donne DG, Viles JH, Groth D, et al. Structure of the recombinant full-length hamster prion protein PrP(29-231): The N terminus is highly flexible. *Proc Natl Acad Sci USA* 1997;94:13452-7.
127. Duffy P, Wolf J, Collins G, Devoe A, Streeten B, Cowen D. Possible person to person transmission of Creutzfeldt-Jakob disease. *N Engl J Med* 1974;290:692-3.
128. Edenhofer F, Rieger R, Famulok M, Wendler W, Weiss S, Winnacker E-L. Prion protein PrP<sup>C</sup> interacts with molecular chaperones of the Hsp60 family. *J Virol* 1996;70:4724-8.
129. Ehlers B, Diringier H. Dextran sulphate 500 delays and prevents mouse scrapie by impairment of agent replication in spleen. *J Gen Virol* 1984;65:1325-30.
130. Eklund CM, Kennedy RC, Hadlow WJ. Pathogenesis of scrapie virus infection in the mouse. *J Infect Dis* 1967;117:15-22.
131. Endo T, Groth D, Prusiner SB, Kobata A. Diversity of oligosaccharide structures linked to asparagines of the scrapie prion protein. *Biochemistry* 1989;28:8380-8.
132. Esmonde T, Lueck CJ, Symon L, Duchon LW, Will RG. Creutzfeldt-Jakob disease and lyophilised dura mater grafts: Report of two cases. *J Neurol Neurosurg Psychiatry* 1993;56:999-1000.
133. Field EJ, Joyce G, Keith A. Failure of interferon to modify scrapie in the mouse. *J Gen Virol* 1969;5:149-150.
134. Fradkin JE, Schonberger LB, Mills JL, et al. Creutzfeldt-Jakob disease in pituitary growth hormone recipients in the United States. *JAMA* 1991;265:880-4.
135. Fraser H, Bruce ME, Chree A, McConnell I, Wells GAH. Transmission of bovine spongiform encephalopathy and scrapie to mice. *J Gen Virol* 1992;73:1891-7.
136. Fraser H, Dickinson AG. The sequential development of the brain lesions of scrapie in three strains of mice. *J Comp Pathol* 1968;78:301-11.
137. Fraser H, Dickinson AG. Scrapie in mice. Agent-strain differences in the distribution and intensity of grey matter vacuolation. *J Comp Pathol* 1973;83:29-40.
138. Fraser H, McConnell I, Wells GAH, Dawson M. Transmission of bovine spongiform encephalopathy to mice. *Vet Rec* 1988;123:472.
139. Friedland RP, Prusiner SB, Jagust WJ, Budinger TF, Davis RL. Bitemporal hypometabolism in Creutzfeldt-Jakob disease measured by positron emission tomography with [18F]-2-fluorodeoxyglucose. *J Comput Assist Tomogr* 1984;8:978-981.
140. Gabizon R, McKinley MP, Groth DF, Kenaga L, Prusiner SB. Properties of scrapie prion liposomes. *J Biol Chem* 1988;263:4950-5.

141. Gabizon R, McKinley MP, Groth DF, Prusiner SB. Immunoaffinity purification and neutralization of scrapie prion infectivity. *Proc Natl Acad Sci USA* 1988;85:6617-21.
142. Gabizon R, Prusiner SB. Prion liposomes. *Biochem J* 1990;266:1-14.
143. Gabizon R, Rosenmann H, Meiner Z, et al. Mutation and polymorphism of the prion protein gene in Libyan Jews with Creutzfeldt-Jakob disease. *Am J Hum Genet* 1993;53:828-35.
144. Gabizon R, Telling G, Meiner Z, Halimi M, Kahana I, Prusiner SB. Insoluble wild-type and protease-resistant mutant prion protein in brains of patients with inherited prion disease. *Nat Med* 1996;2:59-64.
145. Gajdusek DC. Unconventional viruses and the origin and disappearance of kuru. *Science* 1977;197:943-60.
146. Gajdusek DC. Transmissible and non-transmissible amyloidoses: Autocatalytic posttranslational conversion of host precursor proteins to  $\beta$ -pleated sheet configurations. *J Neuroimmunol* 1988;20:95-110.
147. Gajdusek DC, Gibbs CJ Jr, Alpers M. Experimental transmission of a kuru-like syndrome to chimpanzees. *Nature* 1966;209:794-6.
148. Gajdusek DC, Gibbs CJ Jr, Asher DM, et al. Precautions in medical care of and in handling materials from patients with transmissible virus dementia (CJD). *N Engl J Med* 1977;297:1253-8.
149. Gajdusek DC, Zigas V. Degenerative disease of the central nervous system in New Guinea. The endemic occurrence of "kuru" in the native population. *N Engl J Med* 1957;257:974-8.
150. Gajdusek DC, Zigas V. Clinical, pathological and epidemiological study of an acute progressive degenerative disease of the central nervous system among natives of the eastern highlands of New Guinea. *Am J Med* 1959;26:442-69.
151. Gambetti P, Parchi P, Petersen RB, Chen SG, Lugaresi E. Fatal familial insomnia and familial Creutzfeldt-Jakob disease: Clinical, pathological and molecular features. *Brain Pathol* 1995;5:43-51.
152. Gerstmann J, Sträussler E, Scheinker I. Über eine eigenartige hereditär-familiäre Erkrankung des Zentralnervensystems zugleich ein Beitrag zur frage des vorzeitigen lokalen Alterns. *Z Neurol* 1936;154:736-62.
153. Ghetti B, Dlouhy SR, Giaccone G, et al. Gerstmann-Sträussler-Scheinker disease and the Indiana kindred. *Brain Pathol* 1995;5:61-75.
154. Ghetti B, Tagliavini F, Masters CL, et al. Gerstmann-Sträussler-Scheinker disease: II. Neurofibrillary tangles and plaques with PrP-amyloid coexist in an affected family. *Neurology* 1989;39:1453-61.
155. Gibbons RA, Hunter GD. Nature of the scrapie agent. *Nature* 1967;215:1041-3.
156. Gibbs CJ Jr, Amyx HL, Bacote A, Masters CL, Gajdusek DC. Oral transmission of kuru, Creutzfeldt-Jakob disease and scrapie to nonhuman primates. *J Infect Dis* 1980;142:205-8.
157. Gibbs CJ Jr, Asher DM, Brown PW, Fradkin JE, Gajdusek DC. Creutzfeldt-Jakob disease infectivity of growth hormone derived from human pituitary glands. *N Engl J Med* 1993;328:358-9.

158. Gibbs CJ Jr, Gajdusek DC, Amyx H. Strain variation in the viruses of Creutzfeldt-Jakob disease and kuru. In: Prusiner SB, Hadlow WJ, editors. *Slow Transmissible Diseases of the Nervous System*, Vol. 2. New York: Academic Press; 1979. p.87-110.
159. Gibbs CJ Jr, Gajdusek DC, Asher DM, et al. Creutzfeldt-Jakob disease (spongiform encephalopathy): Transmission to the chimpanzee. *Science* 1968;161:388-9.
160. Gibbs CJ Jr, Joy A, Heffner R, et al. Clinical and pathological features and laboratory confirmation of Creutzfeldt-Jakob disease in a recipient of pituitary-derived human growth hormone. *N Engl J Med* 1985;313:734-8.
161. Glasse RM. Cannibalism in the kuru region of New Guinea. *Trans NY Acad Sci [Ser 2]* 1967;29:748-54.
162. Goldberg H, Alter M, Kahana E. The Libyan Jewish focus of Creutzfeldt-Jakob disease: A search for the mode of natural transmission. In: Prusiner SB, Hadlow WJ, editors. *Slow Transmissible Diseases of the Nervous System*, Vol. 1. New York: Academic Press; 1979. p. 195-211.
163. Goldfarb L, Korczyn A, Brown P, Chapman J, Gajdusek DC. Mutation in codon 200 of scrapie amyloid precursor gene linked to Creutzfeldt-Jakob disease in Sephardic Jews of Libyan and non-Libyan origin. *Lancet* 1990;336:637-8.
164. Goldfarb LG, Brown P, Goldgaber D, et al. Creutzfeldt-Jakob disease and kuru patients lack a mutation consistently found in the Gerstmann-Sträussler-Scheinker syndrome. *Exp Neurol* 1990;108:247-50.
165. Goldfarb LG, Brown P, McCombie WR, et al. Transmissible familial Creutzfeldt-Jakob disease associated with five, seven, and eight extra octapeptide coding repeats in the *PRNP* gene. *Proc Natl Acad Sci USA* 1991;88:10926-30.
166. Goldfarb LG, Brown P, Mitrova E, et al. Creutzfeldt-Jacob disease associated with the PRNP codon 200Lys mutation: An analysis of 45 families. *Eur J Epidemiol* 1991;7:477-86.
167. Goldfarb LG, Haltia M, Brown P, et al. New mutation in scrapie amyloid precursor gene (at codon 178) in Finnish Creutzfeldt-Jakob kindred. *Lancet* 1991;337:425.
168. Goldfarb LG, Mitrova E, Brown P, Toh BH, Gajdusek DC. Mutation in codon 200 of scrapie amyloid protein gene in two clusters of Creutzfeldt-Jakob disease in Slovakia. *Lancet* 1990;336:514-5.
169. Goldfarb LG, Petersen RB, Tabaton M, et al. Fatal familial insomnia and familial Creutzfeldt-Jakob disease: Disease phenotype determined by a DNA polymorphism. *Science* 1992;258:806-8.
170. Goldgaber D, Goldfarb LG, Brown P, et al. Mutations in familial Creutzfeldt-Jakob disease and Gerstmann-Sträussler-Scheinker's syndrome. *Exp Neurol* 1989;106:204-6.
171. Goldmann W, Hunter N, Benson G, Foster JD, Hope J. Different scrapie-associated fibril proteins (PrP) are encoded by lines of sheep selected for different alleles of the *Sip* gene. *J Gen Virol* 1991;72:2411-7.
172. Goldmann W, Hunter N, Foster JD, Salbaum JM, Beyreuther K, Hope J. Two alleles of a neural protein gene linked to scrapie in sheep. *Proc Natl Acad Sci USA* 1990;87:2476-80.
173. Goldmann W, Hunter N, Manson J, Hope J. The PrP gene of the sheep, a natural host

of scrapie. Proceedings of the VIIIth International Congress of Virology; 1990 Aug 26-31; Berlin, Germany, p. 284.

174. Goldmann W, Hunter N, Martin T, Dawson M, Hope J. Different forms of the bovine PrP gene have five or six copies of a short, G-C-rich element within the protein-coding exon. *J Gen Virol* 1991;72:201-4.
175. Goldmann W, Hunter N, Smith G, Foster J, Hope J. PrP genotype and agent effects in scrapie: Change in allelic interaction with different isolates of agent in sheep, a natural host of scrapie. *J Gen Virol* 1994;75:989-95.
176. Gomori AJ, Partnow MJ, Horoupian DS, Hirano A. The ataxic form of Creutzfeldt-Jakob disease. *Arch Neurol* 1973;29:318-23.
177. Gordon WS. Advances in veterinary research. *Vet Res* 1946;58:516-20.
178. Gordon WS. Variation in susceptibility of sheep to scrapie and genetic implications. In: Report of Scrapie Seminar, ARS 91-53. Washington, DC: U.S. Department of Agriculture; 1966. p. 53-67.
179. Gorman DG, Benson DF, Vogel DG, Vinters HV. Creutzfeldt-Jakob disease in a pathologist. *Neurology* 1992;42:463.
180. Gorodinsky A, Harris DA. Glycolipid-anchored proteins in neuroblastoma cells form detergent-resistant complexes without caveolin. *J Cell Biol* 1995;129:619-27.
181. Grathwohl K-UD, Horiuchi M, Ishiguro N, Shinagawa M. Sensitive enzyme-linked immunosorbent assay for detection of PrP<sup>Sc</sup> in crude tissue extracts from scrapie-affected mice. *J Virol Methods* 1997;64:205-16.
182. Griffith JS. Self-replication and scrapie. *Nature* 1967;215:1043-4.
183. Hadlow WJ. Scrapie and kuru. *Lancet* 1959;2:289-90.
184. Hadlow WJ, Prusiner SB, Kennedy RC, Race RE. Brain tissue from persons dying of Creutzfeldt-Jakob disease causes scrapie-like encephalopathy in goats. *Ann Neurol* 1980;8:628-31.
185. Haraguchi T, Fisher S, Olofsson S, et al. Asparagine-linked glycosylation of the scrapie and cellular prion proteins. *Arch Biochem Biophys* 1989;274:1-13.
186. Harries-Jones R, Knight R, Will RG, Cousens S, Smith PG, Matthews WB. Creutzfeldt-Jakob disease in England and Wales, 1980-1984: A case-control study of potential risk factors. *J Neurol Neurosurg Psychiatry* 1988;51:1113-9.
187. Harrington MG, Merril CR, Asher DM, Gajdusek DC. Abnormal proteins in the cerebrospinal fluid of patients with Creutzfeldt-Jakob disease. *N Engl J Med* 1986;315:279-83.
188. Hay B, Barry RA, Lieberburg I, Prusiner SB, Lingappa VR. Biogenesis and transmembrane orientation of the cellular isoform of the scrapie prion protein. *Mol Cell Biol* 1987;7:914-20.
189. Hecker R, Taraboulos A, Scott M, et al. Replication of distinct prion isolates is region specific in brains of transgenic mice and hamsters. *Genes Dev* 1992;6:1213-28.
190. Herishanu Y. Antiviral drugs in Jakob-Creutzfeldt disease. *J Am Geriatr Soc* 1973;21:229-31.
191. Heston LL, Lowther DLW, Leventhal CM. Alzheimer's disease: a family study. *Arch Neurol* 1966;15:225-33.



192. Hill AF, Desbruslais M, Joiner S, et al. The same prion strain causes vCJD and BSE. *Nature* 1997;389:448-50.
193. Hintz RL. A prismatic case: The prismatic case of Creutzfeldt-Jakob disease associated with pituitary growth hormone treatment. *J Clin Endocrinol Metab* 1995;80:2298-2301.
194. Holman RC, Khan AS, Belay ED, Schonberger LB. Creutzfeldt-Jakob disease in the United States, 1979-1994: Using national mortality data to assess the possible occurrence of variant cases. *Emerging Inf Dis* 1996;2:333-7.
195. Holman RC, Khan AS, Kent J, Strine TW, Schonberger LB. Epidemiology of Creutzfeldt-Jakob disease in the United States, 1979-1990: Analysis of national mortality data. *Neuroepidemiology* 1995; 14:174-81.
196. Hope J, Reekie LJD, Hunter N, et al. Fibrils from brains of cows with new cattle disease contain scrapie-associated protein. *Nature* 1988;336:390-2.
197. Hornabrook RW. Kuru – a subacute cerebellar degeneration: The natural history and clinical features. *Brain* 1968;91:53-74.
198. Hornabrook RW. Kuru and clinical neurology. In: Prusiner SB and Hadlow WJ, editors. *Slow Transmissible Diseases of the Nervous System*, Vol. 1. New York: Academic Press; 1979. p. 37-66.
199. Hsiao K, Baker HF, Crow TJ, et al. Linkage of a prion protein missense variant to Gerstmann-Sträussler syndrome. *Nature* 1989;338:342-5.
200. Hsiao K, Dlouhy S, Farlow MR, et al. Mutant prion proteins in Gerstmann-Sträussler-Scheinker disease with neurofibrillary tangles. *Nat Genet* 1992;1:68-71.
201. Hsiao K, Meiner Z, Kahana E, et al. Mutation of the prion protein in Libyan Jews with Creutzfeldt-Jakob disease. *N Engl J Med* 1991;324:1091-7.
202. Hsiao K, Prusiner SB. Inherited human prion diseases. *Neurology* 1990;40:1820-27.
203. Hsiao KK, Cass C, Schellenberg GD, et al. A prion protein variant in a family with the telencephalic form of Gerstmann-Sträussler-Scheinker syndrome. *Neurology* 1991;41:681-4.
204. Hsiao KK, Groth D, Scott M, et al. Serial transmission in rodents of neurodegeneration from transgenic mice expressing mutant prion protein. *Proc Natl Acad Sci USA* 1994;91:9126-30.
205. Hsiao KK, Scott M, Foster D, Groth DF, DeArmond SJ, Prusiner SB. Spontaneous neurodegeneration in transgenic mice with mutant prion protein. *Science* 1990;250:1587-90.
206. Hsich G, Kenney K, Gibbs CJ, Lee KH, Harrington MG. The 14-3-3 brain protein in cerebrospinal fluid as a marker for transmissible spongiform encephalopathies. *N Engl J Med* 1996;335:924-30.
207. Huang Z, Gabriel J-M, Baldwin MA, Fletterick RJ, Prusiner SB, Cohen FE. Proposed three-dimensional structure for the cellular prion protein. *Proc Natl Acad Sci USA* 1994;91:7139-43.
208. Huang Z, Prusiner SB, Cohen FE. Scrapie prions: a three-dimensional model of an infectious fragment. *Folding & Design* 1996;1:13-19.
209. Hudson AJ, Farrell MA, Kainins R, Kaufmann JCE. Gerstmann-Sträussler-Scheinker

disease with coincidental familial onset. *Ann Neurol* 1983;14:670-8.

210. Hunter GD, Millson GC, Chandler RL. Observations on the comparative infectivity of cellular fractions derived from homogenates of mouse-scrapie brain. *Res Vet Sci* 1963;4:543-9.
211. Hunter N, Cairns D, Foster JD, Smith G, Goldmann W, Donnelly K. Is scrapie solely a genetic disease? *Nature* 1997;386:137.
212. Hunter N, Foster JD, Benson G, Hope J. Restriction fragment length polymorphisms of the scrapie-associated fibril protein (PrP) gene and their association with susceptibility to natural scrapie in British sheep. *J Gen Virol* 1991;72:1287-92.
213. Hunter N, Foster JD, Dickinson AG, Hope J. Linkage of the gene for the scrapie-associated fibril protein (PrP) to the Sip gene in Cheviot sheep. *Vet Rec* 1989;124:364-6.
214. Hunter N, Goldmann W, Benson G, Foster JD, Hope J. Swaledale sheep affected by natural scrapie differ significantly in PrP genotype frequencies from healthy sheep and those selected for reduced incidence of scrapie. *J Gen Virol* 1993;74:1025-31.
215. Hunter N, Goldmann W, Smith G, Hope J. Frequencies of PrP gene variants in healthy cattle and cattle with BSE in Scotland. *Vet Rec* 1994;135:400-3.
216. Hunter N, Hope J, McConnell I, Dickinson AG. Linkage of the scrapie-associated fibril protein (PrP) gene and Sinc using congenic mice and restriction fragment length polymorphism analysis. *J Gen Virol* 1987;68:2711-16.
217. Hunter N, Moore L, Hosie BD, Dingwall WS, Greig A. Association between natural scrapie and PrP genotype in a flock of Suffolk sheep in Scotland. *Vet Rec* 1997;140:59-63.
218. Ikeda S, Yanagisawa N, Allsop D, Glenner GG. A variant of Gerstmann-Sträussler-Scheinker disease with b protein epitopes and dystrophic neurites in the peripheral regions of PrP – immunoreactive amyloid plaques. In: Natvig JB, Forre O, Husby G, et al., editors. *Amyloid and Amyloidosis 1990*. Dordrecht: Kluwer Academic Publishers; 1991. p. 737-40.
219. Ikeda T, Horiuchi M, Ishiguro N, Muramatsu Y, Kai-Uwe GD, Shinagawa M. Amino acid polymorphisms of PrP with reference to onset of scrapie in Suffolk and Corriedale sheep in Japan. *J Gen Virol* 1995;76:2577-81.
220. Ironside JW. The new variant form of Creutzfeldt-Jakob disease: a novel prion protein amyloid disorder [editorial]. *Amyloid: Int J Exp Clin Invest* 1997;4:66-9.
221. Jaegly A, Boussin F, Deslys J-P, Dormont D. Human growth hormone-related iatrogenic Creutzfeldt-Jakob disease: Search for a genetic susceptibility by analysis of the *PRNP* coding region. *Genomics* 1995;27:382-3.
222. Jakob A. Über eigenartige Erkrankungen des Zentralnervensystems mit bemerkenswertem anatomischen Befunde (spastische Pseudosklerose-Encephalomyelopathie mit disseminierten Degenerationsherden). Preliminary communication. *Dtsch Z Nervenheilk* 1921;70:132-46.
223. Jakob A. Über eigenartige Erkrankungen des Zentralnervensystems mit bemerkenswertem anatomischen Befunde (spastische Pseudosklerose-Encephalomyelopathie mit disseminierten Degenerationsherden). *Z Gesamte Neurol*

224. Jakob A. Über eine der multiplen Sklerose klinisch nahestehende Erkrankung des Zentralnervensystems (spastische Pseudosklerose) mit bemerkenswertem anatomischem Befunde. Mitteilung eines vierten Falles. *Med Klin* 1921;17:372-6.
225. James TL, Liu H, Ulyanov NB, et al. Solution structure of a 142-residue recombinant prion protein corresponding to the infectious fragment of the scrapie isoform. *Proc Natl Acad Sci USA* 1997;94:10086-91.
226. Jarrett JT, Berger EP, Lansbury PT Jr. The carboxy terminus of the b amyloid protein is critical for the seeding of amyloid formation: Implications for the pathogenesis of Alzheimer's disease. *Biochemistry* 1993;32:4693-7.
227. Jarrett JT, Lansbury PT Jr. Amyloid fibril formation requires a chemically discriminating nucleation event: Studies of an amyloidogenic sequence from the bacterial protein OsmB. *Biochemistry* 1992;31:12345-52.
228. Jarrett JT, Lansbury PT Jr. Seeding "one-dimensional crystallization" of amyloid: A pathogenic mechanism in Alzheimer's disease and scrapie? *Cell* 1993;73:1055-8.
229. Jendroska K, Heinzl FP, Torchia M, et al. Proteinase-resistant prion protein accumulation in Syrian hamster brain correlates with regional pathology and scrapie infectivity. *Neurology* 1991;41:1482-90.
230. Josefsberg Z, Aran O, Laron Z. Safety of pituitary growth hormone extracted with acetone/acetic acid. *Lancet* 1994;344:130.
231. Kahana E, Milton A, Braham J, Sofer D. Creutzfeldt-Jakob disease: focus among Libyan Jews in Israel. *Science* 1974;183:90-1.
232. Kaneko K, Vey M, Scott M, Pilkuhn S, Cohen FE, Prusiner SB. COOH-terminal sequence of the cellular prion protein directs subcellular trafficking and controls conversion into the scrapie isoform. *Proc Natl Acad Sci USA* 1997;94:2333-8.
233. Kaneko K, Wille H, Mehlhorn I, et al. Molecular properties of complexes formed between the prion protein and synthetic peptides. *J Mol Biol* 1997;270:574-86.
234. Kaneko K, Zulianello L, Scott M, et al. Evidence for protein X binding to a discontinuous epitope on the cellular prion protein during scrapie prion propagation. *Proc Natl Acad Sci USA* 1997;94:10069-74.
235. Kascsak RJ, Rubenstein R, Merz PA, et al. Mouse polyclonal and monoclonal antibody to scrapie-associated fibril proteins. *J Virol* 1987;61:3688-93.
236. Katz M, Koprowski H. Failure to demonstrate a relationship between scrapie and production of interferon in mice. *Nature* 1968;219:639-40.
237. Kenward N, Hope J, Landon M, Mayer RJ. Expression of polyubiquitin and heat-shock protein 70 genes increases in the later stages of disease progression in scrapie-infected mouse brain. *J Neurochem* 1994;62:1870-7.
238. Kimberlin R, Walker C. Characteristics of a short incubation model of scrapie in the golden hamster. *J Gen Virol* 1977;34:295-304.
239. Kimberlin RH. Reflections on the nature of the scrapie agent. *Trends Biochem Sci* 1982;7:392-4.
240. Kimberlin RH. Scrapie and possible relationships with viroids. *Semin Virol* 1990;1:153-62.

241. Kimberlin RH. Speculations on the origin of BSE and the epidemiology of CJD. In: Gibbs CJ Jr, editor. *Bovine Spongiform Encephalopathy: The BSE Dilemma*. New York: Springer; 1996. p. 155-75.
242. Kimberlin RH, Walker CA. The antiviral compound HPA-23 can prevent scrapie when administered at the time of infection. *Arch Virol* 1983;78:9-18.
243. Kimberlin RH, Walker CA, Fraser H. The genomic identity of different strains of mouse scrapie is expressed in hamsters and preserved on reisolation in mice. *J Gen Virol* 1989;70:2017-25.
244. Kimberlin RH, Walker CA, Millson GC, et al. Disinfection studies with two strains of mouse-passaged scrapie agent. *J Neurol Sci* 1983;59:355-69.
245. Kirschbaum WR. *Jakob-Creutzfeldt Disease*. Amsterdam: Elsevier; 1968. p. 251.
246. Kitamoto T, Tateishi J. Human prion diseases with variant prion protein. *Philos Trans R Soc Lond B Biol Sci* 1994;343:391-8.
247. Kitamoto T, Tateishi J, Tashima I, et al. Amyloid plaques in Creutzfeldt-Jakob disease stain with prion protein antibodies. *Ann Neurol* 1986;20:204-8.
248. Klatzo I, Gajdusek DC, Zigas V. Pathology of kuru. *Lab Invest* 1959;8:799-847.
249. Klitzman RL, Alpers MP, Gajdusek DC. The natural incubation period of kuru and the episodes of transmission in three clusters of patients. *Neuroepidemiology* 1984;3:3-20.
250. Koch TK, Berg BO, DeArmond SJ, Gravina RF. Creutzfeldt-Jakob disease in a young adult with idiopathic hypopituitarism. Possible relation to the administration of cadaveric human growth hormone. *N Engl J Med* 1985;313:731-3.
251. Kocisko DA, Come JH, Priola SA, et al. Cell-free formation of protease-resistant prion protein. *Nature* 1994;370:471-4.
252. Kolata G. Are the horrors of cannibalism fact or fiction? *Smithsonian* 1987;17:151-70.
253. Kondo K, Kuroina Y. A case control study of Creutzfeldt-Jakob disease: Association with physical injuries. *Ann Neurol* 1981;11:377-81.
254. Korth C, Stierli B, Streit P, et al. Prion (PrP<sup>Sc</sup>)-specific epitope defined by a monoclonal antibody. *Nature* 1997;389:74-7.
255. Kretzschmar HA, Honold G, Seitelberger F, et al. Prion protein mutation in family first reported by Gerstmann, Sträussler, and Scheinker. *Lancet* 1991;337:1160.
256. Kretzschmar HA, Neumann M, Stavrou D. Codon 178 mutation of the human prion protein gene in a German family (Backer family): Sequencing data from 72 year-old celloidin-embedded brain tissue. *Acta Neuropathol* 1995;89:96-8.
257. Kretzschmar HA, Stowring LE, Westaway D, Stubblebine WH, Prusiner SB, DeArmond SJ. Molecular cloning of a human prion protein cDNA. *DNA* 1986;5:315-24.
258. Kuroiwa Y, Celesia GG. Clinical significance of periodic EEG patterns. *Arch Neurol* 1980;37:15-20.
259. Kurschner C, Morgan JI. Analysis of interaction sites in homo- and heteromeric complexes containing Bcl-2 family members and the cellular prion protein. *Mol Brain Res* 1996;37:249-58.
260. Kuzuhara S, Kanazawa I, Sasaki H, Nakanishi T, Shimamura K. Gerstmann-Sträussler-Scheinker's disease. *Ann Neurol* 1983;14:216-25.
261. Lampert PW, Gajdusek DC, Gibbs CJ Jr. Subacute spongiform virus

encephalopathies. Scrapie, kuru and Creutzfeldt-Jakob disease: A review. *Am J Pathol* 1972;68:626-52.

262. Lane KL, Brown P, Howell DN, et al. Creutzfeldt-Jakob disease in a pregnant woman with an implanted dura mater graft. *Neurosurgery* 1994;34:737-40.
263. Laplanche J-L, Chatelain J, Beaudry P, Dussaucy M, Bounneau C, Launay J-M. French autochthonous scrapied sheep without the 136Val PrP polymorphism. *Mammalian Genome* 1993;4:463-64.
264. Laplanche J-L, Chatelain J, Launay J-M, Gazengel C, Vidaud M. Deletion in prion protein gene in a Moroccan family. *Nucleic Acids Res* 1990;18:6745.
265. Lasmézas CI, Deslys J-P, Demaimay R, et al. BSE transmission to macaques. *Nature* 1996;381:743-4.
266. Lasmézas CI, Deslys J-P, Robain O, et al. Transmission of the BSE agent to mice in the absence of detectable abnormal prion protein. *Science* 1997;275:402-5.
267. Lechi A, Tedeschi F, Mancina D, et al. Creutzfeldt-Jakob disease: Clinical, EEG and neuropathologic findings in a cluster of eleven patients. *Ital J Neurol Sci* 1983;1:47-59.
268. Lee RG, Blair RDG. Evolution of EEG and visual evoked response changes in Jakob-Creutzfeldt disease. *Electroencephalogr Clin Neurophysiol* 1973;35:133-42.
269. Lehmann S, Harris DA. Two mutant prion proteins expressed in cultured cells acquire biochemical properties reminiscent of the scrapie isoform. *Proc Natl Acad Sci USA* 1996;93:5610-4.
270. Levy RM, Bredesen DE, Rosenblum ML. Neurological manifestations of the acquired immunodeficiency syndrome (AIDS): Experience at UCSF and review of the literature. *J Neurosurg* 1985;62:475-95.
271. Lledo P-M, Tremblay P, DeArmond SJ, Prusiner SB, Nicoll RA. Mice deficient for prion protein exhibit normal neuronal excitability and synaptic transmission in the hippocampus. *Proc Natl Acad Sci USA* 1996;93:2403-7.
272. LoRusso F, Neri G, Figa-Talamanca L. Creutzfeldt-Jakob disease and sheep brain – a report from central and southern Italy. *Ital J Neurol Sci* 1980;3:171-4.
273. Lugaresi E, Medori R, Montagna P, et al. Fatal familial insomnia and dysautonomia with selective degeneration of thalamic nuclei. *N Engl J Med* 1986;315:997-1003.
274. Lumley Jones R, Benker G, Salacinski PR, Lloyd TJ, Lowry PJ. Large-scale preparation of highly purified pyrogen-free human growth hormone for clinical use. *Br J Endocrinol* 1979;82:77-86.
275. Macario ME, Vaisman M, Buescu A, Neto VM, Araujo HMM, Chagas C. Pituitary growth hormone and Creutzfeldt-Jakob disease. *Br Med J* 1991;302:1149.
276. Malmgren R, Kurland L, Mokri B, Kurtzke J. The epidemiology of Creutzfeldt-Jakob disease. In: Prusiner SB, Hadlow WJ, editors. *Slow Transmissible Diseases of the Nervous System*, Vol. 1. New York: Academic Press; 1979. p. 93-112.
277. Manson JC, Clarke AR, Hooper ML, Aitchison L, McConnell I, Hope J. 129/Ola mice carrying a null mutation in PrP that abolishes mRNA production are developmentally normal. *Mol Neurobiol* 1994;8:121-7.
278. Manson JC, Clarke AR, McBride PA, McConnell I, Hope J. PrP gene dosage determines the timing but not the final intensity or distribution of lesions in scrapie

pathology. *Neurodegeneration* 1994;3:331-40.

279. Manuelidis E, Kim J, Angelo J, Manuelidis L. Serial propagation of Creutzfeldt-Jakob disease in guinea pigs. *Proc Natl Acad Sci USA* 1976;73:223-7.
280. Manuelidis EE, Manuelidis L. Observations on Creutzfeldt-Jakob disease propagated in small rodents. In: Prusiner SB, Hadlow WJ, editors. *Slow Transmissible Diseases of the Nervous System*, Vol. 2. New York: Academic Press; 1979. p. 147-73.
281. Manuelidis L. Decontamination of Creutzfeldt-Jakob disease and other transmissible agents. *J Neurovirol* 1997;3:62-5.
282. Manuelidis L, Fritch W. Infectivity and host responses in Creutzfeldt-Jakob disease. *Virology* 1996;216:46-59.
283. Manuelidis L, Fritch W, Xi Y-G. Evolution of a strain of CJD that induces BSE-like plaques. *Science* 1997;277:94-8.
284. Marsh RF, Sipe JC, Morse SS, Hanson RP. Transmissible mink encephalopathy: Reduced spongiform degeneration in aged mink of the Chediak-Higashi genotype. *Lab Invest* 1976;34:381-6.
285. Marzewski DJ, Towfighi J, Harrington MG, Merrill CR, Brown P. Creutzfeldt-Jakob disease following pituitary-derived human growth hormone therapy: A new American case. *Neurology* 1988;38:1131-33.
286. Masters CL, Gajdusek DC, Gibbs CJ Jr. Creutzfeldt-Jakob disease virus isolations from the Gerstmann-Sträussler syndrome. *Brain* 1981;104:559-88.
287. Masters CL, Gajdusek DC, Gibbs CJ Jr. The familial occurrence of Creutzfeldt-Jakob disease and Alzheimer's disease. *Brain* 1981;104:535-58.
288. Masters CL, Gajdusek DC, Gibbs CJ Jr, Bernoulli C, Asher DM. Familial Creutzfeldt-Jakob disease and other familial dementias: An inquiry into possible models of virus-induced familial diseases. In: Prusiner SB and Hadlow WJ, editors. *Slow Transmissible Diseases of the Nervous System*, Vol. 1. New York: Academic Press; 1979. p. 143-94.
289. Masters CL, Harris JO, Gajdusek DC, Gibbs CJ Jr, Bernoulli C, Asher DM. Creutzfeldt-Jakob disease: Patterns of worldwide occurrence and the significance of familial and sporadic clustering. *Ann Neurol* 1978;5:177-88.
290. Masters CL, Richardson EP Jr. Subacute spongiform encephalopathy Creutzfeldt-Jakob disease – the nature and progression of spongiform change. *Brain* 1978;101:333-44.
291. Mastrianni J, Nixon F, Layzer R, DeArmond SJ, Prusiner SB. Fatal sporadic insomnia: Fatal familial insomnia phenotype without a mutation of the prion protein gene. *Neurology* 1997;48 Suppl:A296.
292. Mastrianni JA, Curtis MT, Oberholtzer JC, et al. Prion disease (PrP-A117V) presenting with ataxia instead of dementia. *Neurology* 1995;45:2042-50.
293. Masullo C, Macchi G, Xi YG, Pocchiari M. Failure to ameliorate Creutzfeldt-Jakob disease with amphotericin B therapy. *J Infect Dis* 1992;165:784-5.
294. Masullo C, Pocchiari M, Macchi G, Alema G, Piazza G, Panzera MA. Transmission of Creutzfeldt-Jakob disease by dural cadaveric graft. *J Neurosurg* 1989;71:954.
295. Mathews JD, Glasse R, Lindenbaum S. Kuru and cannibalism. *Lancet* 1968;2:449-52.
296. May WW. Creutzfeldt-Jakob disease. 1. Survey of the literature and clinical diagnosis.

Acta Neurol Scand 1968;44:1-32.

297. Mayer V, Mitrova E, Orolin D. Creutzfeldt-Jakob disease in Czechoslovakia and a working concept of its surveillance. In: Prusiner SB, Hadlow WJ, editors. Slow Transmissible Diseases of the Nervous System, Vol. 1. New York: Academic Press; 1979. p. 287-303.
298. McKinley MP, Bolton DC, Prusiner SB. A protease-resistant protein is a structural component of the scrapie prion. Cell 1983;35:57-62.
299. McKinley MP, Meyer R, Kenaga L, et al. Scrapie prion rod formation *in vitro* requires both detergent extraction and limited proteolysis. J Virol 1991;65:1440-9.
300. Medori R, Montagna P, Tritschler HJ, et al. Fatal familial insomnia: A second kindred with mutation of prion protein gene at codon 178. Neurology 1992;42:669-70.
301. Medori R, Tritschler H-J, LeBlanc A, et al. Fatal familial insomnia, a prion disease with a mutation at codon 178 of the prion protein gene. N Engl J Med 1992;326:444-9.
302. Meggendorfer F. Klinische und genealogische Beobachtungen bei einem Fall von spastischer Pseudosklerose Jakobs. Z Gesamte Neurol Psychiatr 1930;128:337-41.
303. Merz PA, Rohwer RG, Kascsak R, et al. Infection-specific particle from the unconventional slow virus diseases. Science 1984;225:437-40.
304. Merz PA, Somerville RA, Wisniewski HM, Iqbal K. Abnormal fibrils from scrapie-infected brain. Acta Neuropathol (Berl) 1981;54:63-74.
305. Merz PA, Wisniewski HM, Somerville RA, Bobin SA, Masters CL, Iqbal K. Ultrastructural morphology of amyloid fibrils from neuritic and amyloid plaques. Acta Neuropathol (Berl) 1983;60:113-24.
306. Meyer RK, McKinley MP, Bowman KA, Braunfeld MB, Barry RA, Prusiner SB. Separation and properties of cellular and scrapie prion proteins. Proc Natl Acad Sci USA 1986;83:2310-14.
307. Miller DC. Creutzfeldt-Jakob disease in histopathology technicians. N Engl J Med 1988;318:853-4.
308. Millson G, Hunter GD, Kimberlin RH. An experimental examination of the scrapie agent in cell membrane mixtures: II. The association of scrapie infectivity with membrane fractions. J Comp Pathol 1971;81:255-65.
309. Miyashita K, Inuzuka T, Kondo H, et al. Creutzfeldt-Jakob disease in a patient with a cadaveric dural graft. Neurology 1991;41:940-1.
310. Miyazono M, Kitamoto T, Doh-ura K, Iwaki T, Tateishi J. Creutzfeldt-Jakob disease with codon 129 polymorphism (Valine): A comparative study of patients with codon 102 point mutation or without mutations. Acta Neuropathol 1992;84:349-54.
311. Mizutani T, Shiraki H. Clinicopathological Aspects of Creutzfeldt-Jakob Disease. Amsterdam: Elsevier; 1985. p. 325.
312. Monari L, Chen SG, Brown P, et al. Fatal familial insomnia and familial Creutzfeldt-Jakob disease: Different prion proteins determined by a DNA polymorphism. Proc Natl Acad Sci USA 1994;91:2839-42.
313. Moore RC, Hope J, McBride PA, et al. Mice with gene targeted prion protein alterations show that *Prn-p*, *Sinc* and *Prni* are congruent. Nat Genet 1998;18:118-25.
314. Muramoto T, Scott M, Cohen F, Prusiner SB. Recombinant scrapie-like prion protein of

106 amino acids is soluble. Proc Natl Acad Sci USA 1996;93:15457-62.

315. Naslavsky N, Stein R, Yanai A, Friedlander G, Taraboulos A. Characterization of detergent-insoluble complexes containing the cellular prion protein and its scrapie isoform. J Biol Chem 1997;272:6324-31.
316. Nathanson N, Wilesmith J, Griot C. Bovine spongiform encephalopathy (BSE): Cause and consequences of a common source epidemic. Am J Epidemiol 1997;145:959-69.
317. Neugut RH, Neugut AI, Kahana E, Stein Z, Alter M. Creutzfeldt-Jakob disease: Familial clustering among Libyan-born Israelis. Neurology 1979;29:225-31.
318. Nevin S, McMenemy WH, Behrman S, Jones DP. Subacute spongiform encephalopathy – a subacute form of encephalopathy attributable to vascular dysfunction (spongiform cerebral atrophy). Brain 1960;83:519-64.
319. New MI, Brown P, Temeck JW, Owens C, Hedley-Whyte ET, Richardson EP. Preclinical Creutzfeldt-Jakob disease discovered at autopsy in a human growth hormone recipient. Neurology 1988;38:1133-4.
320. Nisbet TJ, MacDonaldson I, Bishara SN. Creutzfeldt-Jakob disease in a second patient who received a cadaveric dura mater graft. J Am Med Assoc 1989;261:1118.
321. Nochlin D, Sumi SM, Bird TD, et al. Familial dementia with PrP-positive amyloid plaques: A variant of Gerstmann-Sträussler syndrome. Neurology 1989;39:910-8.
322. O'Rourke KI, Holyoak GR, Clark WW, et al. PrP genotypes and experimental scrapie in orally inoculated Suffolk sheep in the United States. J Gen Virol 1997;78:975-8.
323. O'Rourke KI, Melco RP, Mickelson JR. Allelic frequencies of an ovine scrapie susceptibility gene. Anim Biotechnol 1996;7:155-62.
324. Oesch B, Teplow DB, Stahl N, Serban D, Hood LE, Prusiner SB. Identification of cellular proteins binding to the scrapie prion protein. Biochemistry 1990;29:5848-55.
325. Oesch B, Westaway D, Wälchli M, et al. A cellular gene encodes scrapie PrP 27-30 protein. Cell 1985;40:735-46.
326. Otto D. Jacob-Creutzfeldt disease associated with cadaveric dura. J Neurosurg 1987;67:149.
327. Owen F, Poulter M, Collinge J, Crow TJ. Codon 129 changes in the prion protein gene in Caucasians. Am J Hum Genet 1990;46:1215-16.
328. Owen F, Poulter M, Lofthouse R, et al. Insertion in prion protein gene in familial Creutzfeldt-Jakob disease. Lancet 1989;1:51-2.
329. Packer RJ, Cornblath DR, Gonatas NK, Bruno LA, Asbury AK. Creutzfeldt-Jakob disease in a 20-year-old woman. Neurology 1980;30:492-6.
330. Palmer MS, Dryden AJ, Hughes JT, Collinge J. Homozygous prion protein genotype predisposes to sporadic Creutzfeldt-Jakob disease. Nature 1991;352:340-2.
331. Palmer MS, Mahal SP, Campbell TA, et al. Deletions in the prion protein gene are not associated with CJD. Hum Molec Genet 1993;2:541-4.
332. Pan K-M, Baldwin M, Nguyen J, et al. Conversion of a helices into b sheets features in the formation of the scrapie prion proteins. Proc Natl Acad Sci USA 1993;90:10962-6.
333. Parchi P, Capellari S, Chen SG, et al. Typing prion isoforms [letter]. Nature 1997;386:232-3.
334. Parchi P, Castellani R, Capellari S, et al. Molecular basis of phenotypic variability in



sporadic Creutzfeldt-Jakob disease. *Ann Neurol* 1996;39:767-78.

335. Parry HB. Scrapie: A transmissible and hereditary disease of sheep. *Heredity* 1962;17: 75-105.
336. Parry HB. Scrapie Disease in Sheep. New York: Academic Press; 1983.
337. Pattison IH. Experiments with scrapie with special reference to the nature of the agent and the pathology of the disease. In: Gajdusek DC, Gibbs CJ Jr, Alpers MP, editors. Slow, Latent and Temperate Virus Infections, NINDB Monograph 2. Washington, DC: U.S. Government Printing; 1965. p. 249-257.
338. Pattison IH. Fifty years with scrapie: A personal reminiscence. *Vet Rec* 1988;123: 661-6.
339. Pattison IH, Jones KM. The possible nature of the transmissible agent of scrapie. *Vet Rec* 1967;80:1-8.
340. Pattison IH, Jones KM. Modification of a strain of mouse-adapted scrapie by passage through rats. *Res Vet Sci* 1968;9:408-10.
341. Peiffer J. Gerstmann-Sträussler's disease, atypical multiple sclerosis and carcinomas in a family of sheepbreeders. *Acta Neuropathol (Berl)* 1982;56:87-92.
342. Peretz D, Williamson RA, Matsunaga Y, et al. A conformational transition at the N terminus of the prion protein features in formation of the scrapie isoform. *J Mol Biol* 1997;273:614-22.
343. Petersen RB, Tabaton M, Berg L, et al. Analysis of the prion protein gene in thalamic dementia. *Neurology* 1992;42:1859-63.
344. Pocchiari M, Peano S, Conz A, et al. Combination ultrafiltration and 6 M urea treatment of human growth hormone effectively minimizes risk from potential Creutzfeldt-Jakob disease virus contamination. *Horm Res* 1991;35:161-6.
345. Pocchiari M, Salvatore M, Ladogana A, et al. Experimental drug treatment of scrapie: A pathogenetic basis for rationale therapeutics. *Eur J Epidemiol* 1991;7:556-61.
346. Poulter M, Baker HF, Frith CD, et al. Inherited prion disease with 144 base pair gene insertion: 1. Genealogical and molecular studies. *Brain* 1992;115:675-85.
347. Powell-Jackson J, Weller RO, Kennedy P, Preece MA, Whitcombe EM, Newsome-Davis J. Creutzfeldt-Jakob disease after administration of human growth hormone. *Lancet* 1985;2:244-6.
348. Prusiner SB. Novel proteinaceous infectious particles cause scrapie. *Science* 1982;216:136-44.
349. Prusiner SB. Scrapie prions. *Ann Rev Microbiol* 1989;43:345-74.
350. Prusiner SB. Molecular biology of prion diseases. *Science* 1991;252:1515-22.
351. Prusiner SB. Prion diseases and the BSE crisis. *Science* 1997;278:245-51.
352. Prusiner SB. Prions. *Les Prix Nobel*. In press 1998.
353. Prusiner SB, Bolton DC, Groth DF, Bowman KA, Cochran SP, McKinley MP. Further purification and characterization of scrapie prions. *Biochemistry* 1982;21:6942-50.
354. Prusiner SB, Cochran SP, Alpers MP. Transmission of scrapie in hamsters. *J Infect Dis* 1985;152:971-8.
355. Prusiner SB, Cochran SP, Groth DF, Downey DE, Bowman KA, Martinez HM. Measurement of the scrapie agent using an incubation time interval assay. *Ann Neurol*

1982;11:353-8.

356. Prusiner SB, Fuzi M, Scott M, et al. Immunologic and molecular biological studies of prion proteins in bovine spongiform encephalopathy. *J Infect Dis* 1993;167:602-13.
357. Prusiner SB, Gajdusek DC, Alpers MP. Kuru with incubation periods exceeding two decades. *Ann Neurol* 1982;12:1-9.
358. Prusiner SB, Groth D, Serban A, et al. Ablation of the prion protein (PrP) gene in mice prevents scrapie and facilitates production of anti-PrP antibodies. *Proc Natl Acad Sci USA* 1993;90:10608-12.
359. Prusiner SB, Groth DF, Bolton DC, Kent SB, Hood LE. Purification and structural studies of a major scrapie prion protein. *Cell* 1984;38:127-34.
360. Prusiner SB, Groth DF, Cochran SP, Masiarz FR, McKinley MP, Martinez HM. Molecular properties, partial purification, and assay by incubation period measurements of the hamster scrapie agent. *Biochemistry* 1980;19:4883-91.
361. Prusiner SB, Groth DF, Cochran SP, McKinley MP, Masiarz FR. Gel electrophoresis and glass permeation chromatography of the hamster scrapie agent after enzymatic digestion and detergent extraction. *Biochemistry* 1980;19:4892-8.
362. Prusiner SB, Hadlow WJ, Garfin DE, et al. Partial purification and evidence for multiple molecular forms of the scrapie agent. *Biochemistry* 1978;17:4993-7.
363. Prusiner SB, McKinley MP, Bolton DC, et al. Prions: Methods for assay, purification and characterization. In: Maramorosch K, Koprowski H, editors. *Methods in Virology*. New York: Academic Press; 1984. p. 293-345.
364. Prusiner SB, McKinley MP, Bowman KA, et al. Scrapie prions aggregate to form amyloid-like birefringent rods. *Cell* 1983;35:349-58.
365. Prusiner SB, Scott M, Foster D, et al. Transgenic studies implicate interactions between homologous PrP isoforms in scrapie prion replication. *Cell* 1990;63:673-86.
366. Prusiner SB, Scott MR, DeArmond SJ, Cohen FE. Prion protein biology. *Cell*. In press 1998.
367. Puckett C, Concannon P, Casey C, Hood L. Genomic structure of the human prion protein gene. *Am J Hum Genet* 1991;49:320-9.
368. Raskin NH, Bredesen D, Ehrenfeld WK, Kerlan R. Periodic confusion caused by congenital extrahepatic portacaval shunt. *Neurology* 1984;34:666-9.
369. Raymond GJ, Hope J, Kocisko DA, et al. Molecular assessment of the potential transmissibilities of BSE and scrapie to humans. *Nature* 1997;388:285-8.
370. Resnick L, DiMarzo-Veronese F, Schupbach J, et al. Intra-blood-brain-barrier synthesis of HTLV-III-specific IgG in patients with neurologic symptoms associated with AIDS or AIDS-related complex. *N Engl J Med* 1985;313:1498-1504.
371. Richardson EPJ. Myoclonic dementia – introduction. In: Rottenberg DA, Hochberg FH, editors. *Neurological Classics in Modern Translation*. New York: Hafner Press; 1977. p. 95-6.
372. Richardson EPJ, Masters CL. The nosology of Creutzfeldt-Jakob disease and conditions related to the accumulation of PrPCJD in the nervous system. *Brain Pathol* 1995;5:33-41.
373. Richardson JH, Barkley WE. Biosafety in Microbiological and Biomedical Laboratories,

U.S. Department of Health and Human Services, Public Health Service, Centers for Disease Control and National Institutes of Health. Washington, DC: U.S. Government Printing Office; 1988.

374. Ridley RM, Baker HF. To what extent is strain variation evidence for an independent genome in the agent of the transmissible spongiform encephalopathies? *Neurodegeneration* 1996;5:219-31.
375. Riek R, Hornemann S, Wider G, Billeter M, Glockshuber R, Wüthrich K. NMR structure of the mouse prion protein domain PrP(121-231). *Nature* 1996;382:180-2.
376. Roberts GW, Lofthouse R, Allsop D, et al. CNS amyloid proteins in neurodegenerative diseases. *Neurology* 1988;38:1534-40.
377. Roberts GW, Lofthouse R, Brown R, Crow TJ, Barry RA, Prusiner SB. Prion-protein immunoreactivity in human transmissible dementias. *N Engl J Med* 1986;315:1231-3.
378. Robinson MM, Hadlow WJ, Knowles DP, et al. Experimental infection of cattle with the agents of transmissible mink encephalopathy and scrapie. *J Comp Path* 1995;113: 241-51.
379. Roos R, Gajdusek DC, Gibbs CJ Jr. The clinical characteristics of transmissible Creutzfeldt-Jakob disease. *Brain* 1973;96:1-20.
380. Rosenberg RN, White LL III, Brown P, et al. Precautions in handling tissues, fluids, and other contaminated materials from patients with documented or suspected Creutzfeldt-Jakob disease. *Ann Neurol* 1986;19:75-7.
381. Rosenmann H, Meiner Z, Kahana E, et al. Detection of 14-3-3 protein in the CSF of genetic Creutzfeldt-Jakob disease. *Neurology* 1997;49:593-5.
382. Rosenthal NP, Keeseey J, Crandall B, Brown WJ. Familial neurological disease associated with spongiform encephalopathy. *Arch Neurol* 1976;33:252-9.
383. Safar J, Wang W, Padgett MP, et al. Molecular mass, biochemical composition, and physicochemical behavior of the infectious form of the scrapie precursor protein monomer. *Proc Natl Acad Sci USA* 1990;87:6373-7.
384. Sakaguchi S, Katamine S, Nishida N, et al. Loss of cerebellar Purkinje cells in aged mice homozygous for a disrupted PrP gene. *Nature* 1996;380:528-31.
385. Sakaguchi S, Katamine S, Shigematsu K, et al. Accumulation of proteinase K-resistant prion protein (PrP) is restricted by the expression level of normal PrP in mice inoculated with a mouse-adapted strain of the Creutzfeldt-Jakob disease agent. *J Virol* 1995;69:7586-92.
386. Salazar AM, Masters CL, Gajdusek DC, Gibbs CJ Jr. Syndromes of amyotrophic lateral sclerosis and dementia: Relation to transmissible Creutzfeldt-Jakob disease. *Ann Neurol* 1983;14:17-26.
387. Schoene WC, Masters CL, Gibbs CJ Jr, et al. Transmissible spongiform encephalopathy (Creutzfeldt-Jakob disease). *Arch Neurol* 1981;38:473-7.
388. Scott M, Foster D, Miranda C, et al. Transgenic mice expressing hamster prion protein produce species-specific scrapie infectivity and amyloid plaques. *Cell* 1989;59:847-57.
389. Scott M, Groth D, Foster D, et al. Propagation of prions with artificial properties in transgenic mice expressing chimeric PrP genes. *Cell* 1993;73:979-88.
390. Scott MR, Groth D, Tatzelt J, et al. Propagation of prion strains through specific

conformers of the prion protein. *J Virol* 1997;71:9032-44.

391. Scott MR, Safar J, Telling G, et al. Identification of a prion protein epitope modulating transmission of bovine spongiform encephalopathy prions to transgenic mice. *Proc Natl Acad Sci USA* 1997;94:14279-84.
392. Seitelberger F. Spinocerebellar ataxia with dementia and plaque-like deposits (Sträussler's disease). In: Vinken PJ, Bruyn GW, editors. *Handbook of Clinical Neurology*, Vol. 42. Amsterdam: North-Holland; 1981. p. 182-3.
393. Seitelberger F. Straubler's disease. *Acta Neuropathol (Berl)* 1981;7 Suppl:341-3.
394. Serban D, Taraboulos A, DeArmond SJ, Prusiner SB. Rapid detection of Creutzfeldt-Jakob disease and scrapie prion proteins. *Neurology* 1990;40:110-7.
395. Shibuya S, Higuchi J, Shin R-W, Tateishi J, Kitamoto T. Protective prion protein polymorphisms against sporadic Creutzfeldt-Jakob disease. *Lancet* 1998;351:419.
396. Shinde UP, Liu JJ, Inouye M. Protein memory through altered folding mediated by intramolecular chaperones. *Nature* 1997;389:520-2.
397. Siedler H, Malamud N. Creutzfeldt-Jakob's disease. Clinicopathologic report of 15 cases and review of the literature (with special reference to a related disorder designated as subacute spongiform encephalopathy). *J Neuropathol Exp Neurol* 1963;22:381-402.
398. Simpson DA, Lander H, Robson HN. Observations on kuru: II. Clinical features. *Aust Ann Med* 1959;8:8-15.
399. Sitwell L, Lach B, Atack E, Atack D, Izukawa D. Creutzfeldt-Jakob disease in histopathology technicians. *N Engl J Med* 1988;318:854.
400. Snider WD, Simpson DM, Nielsen S, Gold JW, Metroka CE, Posner JB. Neurological complications of acquired immune deficiency syndromes: Analysis of 50 patients. *Ann Neurol* 1983;14:403-18.
401. Somerville RA, Chong A, Mulqueen OU, Birkett CR, Wood SCER, Hope J. Biochemical typing of scrapie strains. *Nature* 1997;386:564.
402. Spudich S, Mastrianni JA, Wrensch M, et al. Complete penetrance of Creutzfeldt-Jakob disease in Libyan Jews carrying the E200K mutation in the prion protein gene. *Mol Med* 1995;1:607-13.
403. Steiner I, Polacheck I, Melamed E. Dementia and myoclonus in a case of cryptococcal encephalitis. *Arch Neurol* 1984;41:216-17.
404. Stekel DJ, Nowak MA, Southwood TRE. Prediction of future BSE spread. *Nature* 1996;381:119.
405. Stender A. Weitere Beiträge zum Kapitel "Spastische Pseudosklerose Jakobs". *Z Gesamte Neurol Psychiatr* 1930;128:528-43.
406. Sumi SM, Nochlin D, Bird TD. Familial presenile dementia with neurofibrillary tangles but without senile (neuritic) plaques: Is this familial Alzheimer's disease? *Neurology* 1988;38(Suppl 1):266.
407. Tagliavini F, Prelli F, Ghiso J, et al. Amyloid protein of Gerstmann-Sträussler-Scheinker disease (Indiana kindred) is an 11-kd fragment of prion protein with an N-terminal glycine at codon 58. *EMBO J* 1991;10:513-9.
408. Tagliavini F, Prelli F, Porro M, et al. Amyloid fibrils in Gerstmann-Sträussler-Scheinker

disease (Indiana and Swedish kindreditors) express only PrP peptides encoded by the mutant allele. *Cell* 1994;79:695-703.

409. Tange RA, Troost D, Limburg M. Progressive fatal dementia (Creutzfeldt-Jakob disease) in a patient who received homograft tissue for tympanic membrane closure. *Eur Arch Otorhinolaryngol* 1989;247:199-201.
410. Taraboulos A, Jendroska K, Serban D, Yang S-L, DeArmond SJ, Prusiner SB. Regional mapping of prion proteins in brains. *Proc Natl Acad Sci USA* 1992;89:7620-24.
411. Taraboulos A, Scott M, Semenov A, Avrahami D, Laszlo L, Prusiner SB. Cholesterol depletion and modification of COOH-terminal targeting sequence of the prion protein inhibits formation of the scrapie isoform. *J Cell Biol* 1995;129:121-32.
412. Tateishi J, Doi H, Sato Y, Suetsugu M, Ishii K, Kuroiwa Y. Experimental transmission of human subacute spongiform encephalopathy to small rodents: III. Further transmission from three patients and distribution patterns of lesions in mice. *Acta Neuropathol (Berl)* 1981;53:161-3.
413. Tateishi J, Hikita K, Nagara H, Sato Y, Koga M. Transmission of Creutzfeldt-Jakob disease and production of amyloid plaques in rodents: Sixth International Congress of Virology; 1984 Sep 1-7; Sendai, Japan. p. 76.
414. Tateishi J, Kitamoto T. Developments in diagnosis for prion diseases. *Br Med Bull* 1993;49:971-9.
415. Tateishi J, Kitamoto T, Doh-ura K, et al. Immunochemical, molecular genetic, and transmission studies on a case of Gerstmann-Sträussler-Scheinker syndrome. *Neurology* 1990;40:1578-81.
416. Tateishi J, Kitamoto T, Hashiguchi H, Shii H. Gerstmann-Sträussler-Scheinker disease: Immunohistological and experimental studies. *Ann Neurol* 1988;24:35-40.
417. Tateishi J, Kitamoto T, Hoque MZ, Furukawa H. Experimental transmission of Creutzfeldt-Jakob disease and related diseases to rodents. *Neurology* 1996;46:532-7.
418. Tateishi J, Koga M, Sato Y, Mori R. Properties of the transmissible agent derived from chronic spongiform encephalopathy. *Ann Neurol* 1980;7:390-1.
419. Tateishi J, Nagara H, Hikita K, Sato Y. Amyloid plaques in the brains of mice with Creutzfeldt-Jakob disease. *Ann Neurol* 1984;15:278-80.
420. Tateishi J, Ohta M, Koga M, Sato Y, Kuroiwa Y. Transmission of chronic spongiform encephalopathy with kuru plaques from humans to small rodents. *Ann Neurol* 1979;5:581-4.
421. Tateishi J, Sato Y, Nagara H, Boellaard JW. Experimental transmission of human subacute spongiform encephalopathy to small rodents: IV. Positive transmission from a typical case of Gerstmann-Sträussler-Scheinker's disease. *Acta Neuropathol (Berl)* 1984;64:85-8.
422. Tatzelt J, Prusiner SB, Welch WJ. Chemical chaperones interfere with the formation of scrapie prion protein. *EMBO J* 1996;15:6363-73.
423. Tatzelt J, Zuo J, Voellmy R, et al. Scrapie prions selectively modify the stress response in neuroblastoma cells. *Proc Natl Acad Sci USA* 1995;92:2944-48.
424. Taylor DM, Dickinson AG, Fraser H, Robertson PA, Salacinski PR, Lowry PJ. Preparation of growth hormone free from contamination with unconventional slow

viruses. *Lancet* 1985;2:260-2.

425. Taylor DM, Fraser H, McConnell I, et al. Decontamination studies with the agents of bovine spongiform encephalopathy and scrapie. *Arch Virol* 1994;139:313-26.
426. Taylor DM, Woodgate SL, Atkinson MJ. Inactivation of the bovine spongiform encephalopathy agent by rendering procedures. *Vet Rec* 1995;137:605-10.
427. Taylor DM, Woodgate SL, Fleetwood AJ, Cawthorne RJG. Effect of rendering procedures on the scrapie agent. *Vet Rec* 1997;141:643-9.
428. Taylor KC. The control of bovine spongiform encephalopathy in Great Britain. *Vet Rec* 1991;129:522-6.
429. Telling GC, Haga T, Torchia M, Tremblay P, DeArmond SJ, Prusiner SB. Interactions between wild-type and mutant prion proteins modulate neurodegeneration in transgenic mice. *Genes & Dev* 1996;10:1736-50.
430. Telling GC, Parchi P, DeArmond SJ, et al. Evidence for the conformation of the pathologic isoform of the prion protein enciphering and propagating prion diversity. *Science* 1996;274:2079-82.
431. Telling GC, Scott M, Hsiao KK, et al. Transmission of Creutzfeldt-Jakob disease from humans to transgenic mice expressing chimeric human-mouse prion protein. *Proc Natl Acad Sci USA* 1994;91:9936-40.
432. Telling GC, Scott M, Mastrianni J, et al. Prion propagation in mice expressing human and chimeric PrP transgenes implicates the interaction of cellular PrP with another protein. *Cell* 1995;83:79-90.
433. Terzano MG, Montanari E, Calzetti S, Mancina D, Lechi A. The effect of amantadine on arousal and EEG patterns in Creutzfeldt-Jakob disease. *Arch Neurol* 1983;40:555-9.
434. Thadani V, Penar PL, Partington J, et al. Creutzfeldt-Jakob disease probably acquired from a cadaveric dura mater graft. Case report. *J Neurosurg* 1988;69:766-9.
435. Titner R, Brown P, Hedley-Whyte ET, Rappaport EB, Piccardo CP, Gajdusek DC. Neuropathologic verification of Creutzfeldt-Jakob disease in the exhumed American recipient of human pituitary growth hormone: Epidemiologic and pathogenetic implications. *Neurology* 1986;36:932-6.
436. Tobler I, Gaus SE, Deboer T, et al. Altered circadian activity rhythms and sleep in mice devoid of prion protein. *Nature* 1996;380:639-42.
437. Traub RD, Pedley TA. Virus-induced electronic coupling: hypothesis on the mechanism of periodic EEG discharges in Creutzfeldt-Jakob disease. *Ann Neurol* 1981;10:405-10.
438. Vey M, Pilkuhn S, Wille H, et al. Subcellular colocalization of the cellular and scrapie prion proteins in caveolae-like membranous domains. *Proc Natl Acad Sci USA* 1996;93:14945-9.
439. Vnencak-Jones CL, Phillips JA. Identification of heterogeneous PrP gene deletions in controls by detection of allele-specific heteroduplexes (DASH). *Am J Hum Genet* 1992;50:871-2.
440. Walker AS, Inderlied CB, Kingsbury DT. Conditions for the chemical and physical inactivation of the K. Fu. strain of the agent of Creutzfeldt-Jakob disease. *Am J Public Health* 1983;73:661-5.
441. Watson CP. Clinical similarity of Alzheimer and Creutzfeldt-Jakob disease. *Ann Neurol*

1979;6:368-9.

442. Weiss R. Study of 'mad cow' disease challenges prevailing theory. International Herald Tribune 1997 Jan 18-19;2.
443. Weissmann C. Spongiform encephalopathies – the prion's progress. Nature 1991;349:569-71.
444. Weissmann C. A "unified theory" of prion propagation. Nature 1991;352:679-83.
445. Westaway D, Goodman PA, Miranda CA, McKinley MP, Carlson GA, Prusiner SB. Distinct prion proteins in short and long scrapie incubation period mice. Cell 1987;51:651-62.
446. Westaway D, Zuliani V, Cooper CM, et al. Homozygosity for prion protein alleles encoding glutamine-171 renders sheep susceptible to natural scrapie. Genes Dev 1994;8:959-69.
447. Wickner RB. A new prion controls fungal cell fusion incompatibility [commentary]. Proc Natl Acad Sci USA 1997;94:10012-14.
448. Wilesmith JW. The epidemiology of bovine spongiform encephalopathy. Semin Virol 1991;2:239-45.
449. Wilesmith JW, Ryan JBM, Atkinson MJ. Bovine spongiform encephalopathy – epidemiologic studies on the origin. Vet Rec 1991;128:199-203.
450. Will RG, Ironside JW, Zeidler M, et al. A new variant of Creutzfeldt-Jakob disease in the UK. Lancet 1996;347:921-5.
451. Will RG, Matthews WB. Evidence for case-to-case transmission of Creutzfeldt-Jakob disease. J Neurol Neurosurg Psychiatry 1982;45:235-8.
452. Will RG, Matthews WB. A retrospective study of Creutzfeldt-Jakob disease in England and Wales 1970-79: I. Clinical features. J Neurol Neurosurg Psychiatry 1984;47:134-140.
453. Willison HJ, Gale AN, McLaughlin JE. Creutzfeldt-Jakob disease following cadaveric dura mater graft. J Neurol Neurosurg Psychiatry 1991;54:940.
454. Wisniewski HM, Moretz RC, Lossinsky AS. Evidence for induction of localized amyloid deposits and neuritic plaques by an infectious agent. Ann Neurol 1981;10:517-22.
455. Worthington M. Interferon system in mice infected with the scrapie agent. Infect Immun 1972;6:643-5.
456. Xi YG, Ingrosso L, Ladogana A, Masullo C, Pocchiari M. Amphotericin B treatment dissociates *in vivo* replication of the scrapie agent from PrP accumulation. Nature 1992;356:598-601.
457. Yagishita S. Creutzfeldt-Jakob disease with kuru-like plaques in Japan. Acta Pathol Jpn 1981;31:923-42.
458. Zarranz JJ, Rivera-Pomar JM, Salisachs P. Kuru plaques in the brain of two cases with Creutzfeldt-Jakob disease. J Neurol Sci 1979;43:291-300.
459. Zerr I, Bodemer M, Gefeller O, et al. Detection of 14-3-3 protein in the cerebrospinal fluid supports the diagnosis of Creutzfeldt-Jakob disease. Ann Neurol 1998;43:32-40.
460. Zhang H, Kaneko K, Nguyen JT, et al. Conformational transitions in peptides containing two putative  $\alpha$  helices of the prion protein. J Mol Biol 1995;250:514-26.
461. Zhang H, Stöckel J, Mehlhorn I, et al. Physical studies of conformational plasticity in a

recombinant prion protein. *Biochemistry* 1997;36:3543-53.

462. Zigas V, Gajdusek DC. Kuru: Clinical study of a new syndrome resembling paralysis agitans in natives of the Eastern Highlands of Australian New Guinea. *Med J Aust* 1957;2:745-54.

463. Zlotnik I. The pathology of scrapie: A comparative study of lesions in the brain of sheep and goats. *Acta Neuropathol (Berl)* 1962;1 Suppl:61-70.





# Epidemiology of Creutzfeldt-Jakob Disease

Robert G. Will, M.D.

*National Creutzfeldt-Jakob Disease Surveillance Unit, U.K.*

Extensive information on the epidemiology of Creutzfeldt-Jakob disease (CJD) has been accumulated since the original transmission of CJD to primates in 1968. One aim of this research was to discover the mechanism of natural transmission of CJD. The epidemiological evidence virtually precludes case-to-case transmission as a causative mechanism, except in rare iatrogenic cases, and has provided little evidence to suggest an environmental 'source of infection'. New variant Creutzfeldt-Jakob disease (nvCJD) is a novel human spongiform encephalopathy with a consistent clinico-pathological phenotype. Epidemiological evidence indicates that this disease is occurring almost exclusively in the United Kingdom, where there has been an epidemic of spongiform encephalopathy in the cattle population. Current evidence strongly supports the hypothesis that there is a causal link between bovine spongiform encephalopathy and nvCJD.

# **Incidence/Geographical Distribution of Creutzfeldt-Jakob Disease**

The overall incidence of Creutzfeldt-Jakob disease (CJD) in systematic surveys ranges from about 0.5 to 1 case/million/year. The possibility of a true incidence rate that is significantly higher has arisen, at least in part due to reports from a number of countries of localized areas of high incidence. Incidence data from the harmonized surveillance system in a number of European countries, however, has shown current incidence figures of 0.7 cases/million/year [8]. The geographical distribution of CJD in the United Kingdom (U.K.) over the past 20 years demonstrates no overall evidence of spatio-temporal aggregation of cases [11] despite the occurrence of local areas of relatively high incidence over short periods.

The absence of convincing evidence of aggregation of cases of CJD in any systematic survey indicates that CJD, as a rare and geographical widespread phenomenon, cannot be maintained by case-to-case transmission. The implication is that close contact with cases of CJD cannot be a risk factor for the development of disease. Spouses of sporadic cases do not have an increased incidence of disease [2] and in familial aggregates only those with a mutation of the 'prion protein gene' develop disease, despite close contact between individual family members, often over decades [10]. Molecular biological evidence has also demonstrated that the 60- to 100-fold increase in CJD incidence in Slovakia and Libyan-born Israelis is related to a high frequency of PrP gene mutations and not to contact transmission or environmental risk factors [12,18].

Following the original transmission of CJD, scrapie in sheep was considered as a candidate risk factor for CJD. Scrapie is endemic in many countries, including the U.K. and France, and isolated outbreaks have been described in other countries previously thought to be free of scrapie including Japan, Sweden, and probably Czechoslovakia. Some countries are almost certainly free of scrapie, including Australia and New Zealand. This contrasts with the distribution of CJD which has been identified in all developed countries, including Australia and New Zealand, and in an increasing number of countries with less well-developed medical services. It is reasonable to presume that CJD occurs throughout the world [15]; furthermore, available evidence suggests that the incidence in individual countries is independent either of the sheep population or the incidence of scrapie. This not only suggests that scrapie is unlikely to be causally related to CJD, but also that any putative risk factor must be ubiquitous and independent of climatic, cultural, or economic differences between countries. This has led to the proposition that sporadic cases of CJD may be due to spontaneous generation of a self-replicating protein, perhaps by somatic mutation [13].

# Risk Factors for CJD

## *Familial Incidence*

The familial occurrence of CJD in 5 to 15% of cases with an apparently dominant pattern of inheritance has been long recognized [15]. Molecular biological research has demonstrated that the familial occurrence of CJD is related to the presence of mutations of the PrP gene and not to contact transmission or vertical transmission of a viral-like agent [10]. In familial cases of CJD there may be variation in clinical presentation and pathological features with a proportion of cases neither clinically nor pathologically typical of CJD. This raises the possibility that prion diseases might be more widespread than previously recognized, and indeed genetic screening of a range of familial neurodegenerative disorders has resulted in the identification of novel phenotypes, including fatal familial insomnia [17]. Other than a slightly earlier average age of disease onset, however, the clinical features in association with the codon 200 mutation are indistinguishable from CJD [3] and in families with other mutations, including those with multiple octopeptide repeats, the onset of progressive neuropsychiatric dysfunction at an early age is rare in general neurological practice. Preliminary evidence from screening studies in dementia [21] and from a group of cases of atypical dementia [4] suggests that PrP mutations in suspect Alzheimer's disease or unusual forms of sporadic dementia are likely to be discovered only exceptionally in these groups, if at all.

The frequency of familial CJD ranges from 6 to 15% of cases of CJD in different studies [2]. This disparity is due to differing methodologies of ascertainment and also to varying criteria for the definition of a familial case. Rigid criteria requiring the identification of definite or probable CJD in more than one family member will inevitably underestimate the true familial incidence. Likewise, criteria allowing any case of dementia in a relative of an index case to be classified as CJD will overestimate the familial incidence because of the inclusion of cases of more common forms of dementia such as Alzheimer's disease. In one national survey, 12% of all incident cases were classified as familial on the basis of PrP gene screening [26].

## *Iatrogenic Transmission*

CJD has been accidentally transmitted from person to person through a variety of routes although all have involved potential cross-contamination with CNS tissue and, by implication, high titres of infectivity.

Central inoculation through neurosurgery, depth electrodes, corneal grafts, or dura mater grafts results in disease after a mean incubation period of about 2 years and a clinical presentation similar to sporadic CJD. Peripheral inoculation through human pituitary-derived growth hormone (HGH) or pituitary-derived gonadotrophin (HGnH) results in disease after an incubation period of about 12 years (range, 4 to at least 30 years). The clinical presentation in HGH and HGnH recipients is remarkably stereotyped with a progressive cerebellar syndrome and if at all, late development of cognitive impairment. This closely parallels the clinical course in kuru and the likeliest explanation of the contrasting clinical

presentation between central and peripheral inoculation is the route of inoculation of the agent. There is evidence of a genetic influence on susceptibility in HGH recipients with a relative excess of valine homozygosity at codon 129 of the PrP gene. This contrasts with a relative excess of methionine homozygosity at codon 129 in cases of sporadic CJD [19] and in iatrogenic cases due to central contamination, therefore providing some support for the hypothesis that sporadic CJD may develop centrally and spontaneously rather than from some external factor.

The risk of developing CJD in HGH recipients has been judged to be approximately 1 in 200 on the basis of epidemiological data [5] and laboratory studies of decontamination procedures [20]. Recently, the increasing number of CJD-affected HGH recipients in France has suggested that the relative risk may vary from country to country, perhaps in relation to the level of contamination of source material.

### *Dietary Factors*

The hypothesis that dietary contamination with the scrapie agent might lead to CJD has been eroded by cumulative epidemiological and molecular biological evidence. The anecdotal reports of CJD developing in individuals with dietary exposure to sheep brain [14] or other potentially scrapie-infected material have been balanced by reports of CJD in vegetarians [16,22]. Case-control studies have been mutually contradictory and have failed to reveal consistent evidence of an increase of CJD incidence in relation to dietary factors. The increased incidence in Libyan-born Israelis is now known to be due to molecular biological factors rather than dietary factors, consistent with the previous case-control study which showed no difference in dietary habits between affected and unaffected members in this ethnic group [9].

Together with the disparity between worldwide distributions of scrapie and CJD, available evidence suggests that scrapie cannot be an important etiological factor in CJD, although the possibility that scrapie is causally linked to occasional cases of CJD cannot be completely excluded.

### *Occupation*

Descriptive and analytical studies have failed to provide any convincing evidence of an increased risk of CJD with regards to occupation, although the small numbers of cases in at-risk occupational groups does "not permit any meaningful conclusions to be drawn about relative risk, whatever statistical tests are used" [2]. The possibility that contact with cases of CJD might lead to increased risk has led to careful analysis of CJD frequency among medical and paramedical staff. Although one early study showed an apparent increase in CJD frequency within these groups [15], systematic surveys have failed to show an overall increased risk, including a case-control analysis of occupation throughout life [11]. This indicates that contact with individual patients suffering from CJD is unlikely to be a risk in itself, further substantiated by the epidemiological evidence which suggests that there is no significantly increased risk to spouses of affected patients.

There have been individual case reports of CJD developing in a neurosurgeon, a

pathologist, two histology technicians, and most recently, in an individual who had processed human and sheep dura mater [1,23]. Any causal link between these occupations and the development of CJD, however, is hypothetical and must be judged against the known epidemiology which has demonstrated no definite occupational links. The current case-control study of occupation in the U.K. has shown no significant difference between cases and controls. In particular, there were no observed differences in the frequency of various 'at-risk' occupations (such as abattoir workers, farmers, or butchers) in which there is a potential occupational exposure to CNS tissue from animals affected by bovine spongiform encephalopathy (BSE).

### *New Variant CJD*

Surveillance of CJD was initiated in the U.K. in May 1990 to identify any change in the characteristics of this condition following the occurrence of BSE in British cattle. In 1996 a novel form of CJD, designated new variant CJD (nvCJD), was identified by the CJD Surveillance Unit (CJDSU). It was proposed that these cases might be causally linked to the occurrence of BSE [25].

The original 10 cases of nvCJD were first linked because of a remarkably early age of onset (mean, 29 years) in comparison to previous experience of CJD from systematic surveys which consistently indicated that CJD was predominantly a disease of late middle-age. Clinically, the cases were also unusual because of a consistent phenotype, including early psychiatric symptoms and a prolonged duration of illness averaging over 12 months in comparison to 4 months in classic cases.

By January 1998, 13 additional cases of nvCJD were identified in the U.K. as well as a further case in France [7]; all have a clinical phenotype consistent with the original description. The incidence of CJD in cases aged less than 35 years at death, based on the original 10 cases, was statistically clearly distinct from previous experience (Figure 1). Of the 23 cases (including one probable case) of nvCJD in the U.K., 18 cases were less than 35 years of age at death and 19 cases were 35 years of age or less at disease onset. The duration of illness in these 23 cases in the U.K. averaged 16 months (range, 8 to 38 months), while the average age at symptom onset is 27 years (range, 16 to 48 years). The year of onset of clinical symptoms and year of death for the 23 U.K. cases are listed in Table 1. No definite change in the rate of occurrence of nvCJD was seen, particularly in relation to disease onsets. The overall evidence is consistent with the continuing occurrence of a novel form of CJD.

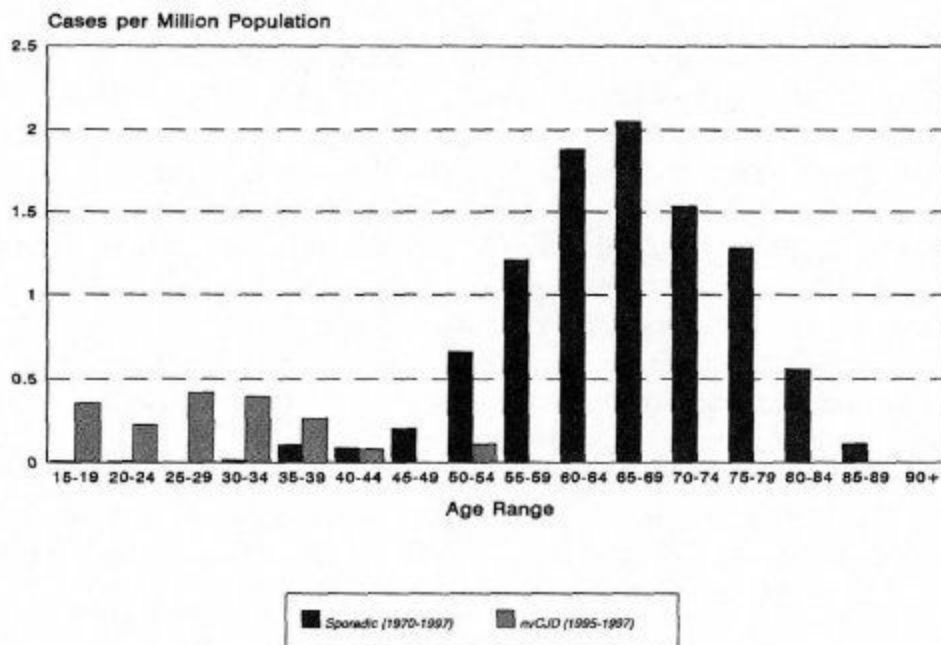

**Figure 1.** Creutzfeldt-Jakob disease: Age-specific incidence rates for age at death.

**Table 1.** Year of Clinical Onset and Death of nvCJD Cases in the U.K.

Year	Onset	Death
1994	7	0
1995	9	3
1996	7	10
1997	0	10

The most powerful evidence linking the first 10 cases was the neuropathological phenotype and all subsequent cases have exhibited neuropathological features consistent with the original description. Review of material from past cases of CJD held at the CJDSU was performed prior to the announcement of the identification of nvCJD and has continued but no similar past case has been identified. Crucially, extensive review of neuropathological archives in other countries has also failed to lead to the identification of even a single similar case. Current evidence suggests that as originally proposed, the neuropathology of nvCJD is indeed novel.

### *Epidemiology*

The proposition that BSE and nvCJD were causally linked was based in part on the novelty of nvCJD. The identification of a new clinico-pathological form of CJD, however, does not in itself allow any conclusions regarding etiology. Evidence of a causal link with any putative novel risk factor such as BSE depends on the timing of the occurrence of any related human disease, the geographical co-localization of such cases with the risk factor, and the identification of a common exposure in affected patients.

BSE was identified in 1996 through the U.K. veterinary surveillance system, although in retrospect, there were almost certainly cases in 1985. With an incubation period averaging 5 to 6 years, exposure of the U.K. cattle population to infection is likely to have started early in the 1980s [24], presumably through animal feed in the form of meat and bone meal contaminated initially with sheep scrapie and later with BSE itself. Exposure of the human population to the BSE agent may have started in the early 1980s. This exposure may have continued to increase until affected animals were excluded from the human food chain in 1988 and a ban on the use of a range of bovine tissues, including brain and spinal cord from all cattle, in human (and animal) food in 1989.

Speculation on the likely timing of the occurrence of a BSE-related human disease is based on inference from data on the incubation period in human prion diseases, including kuru and CJD. In kuru, the incubation period ranges from 4.5 to over 30 years, but there is no definitive data on the mean incubation period. Evidence on incubation periods in CJD comes from iatrogenic cases [5]. With central inoculation through neurosurgical procedures or dura mater grafts, the incubation periods are relatively short, ranging from 18 months to a few years, although there are occasional cases of dura mater-related CJD with incubation periods exceeding 10 years. Transmission of BSE to humans would not involve direct implantation of infectivity in the CNS but oral exposure through dietary contamination or perhaps some other peripheral route. The closest analogy in iatrogenic CJD is the occurrence of CJD cases following human pituitary hormone therapy administered by peripheral injection. In these cases incubation periods range from about 5 years to over 25 years, with a mean of 13 years. In prion diseases, the incubation period is shortest with intraspecies transmission and is usually extended when crossing from one species to another. The incubation period of BSE in humans is therefore likely to be longer than in pituitary hormone-related CJD. Human exposure to BSE potentially started in the early 1980s and it is reasonable to propose that a BSE-related human disease might have first occurred in the mid-1990s, with a putative minimum incubation period ranging from approximately 6 to 12 years (Figure 2). The disease onsets of the first cases of nvCJD were in 1994.



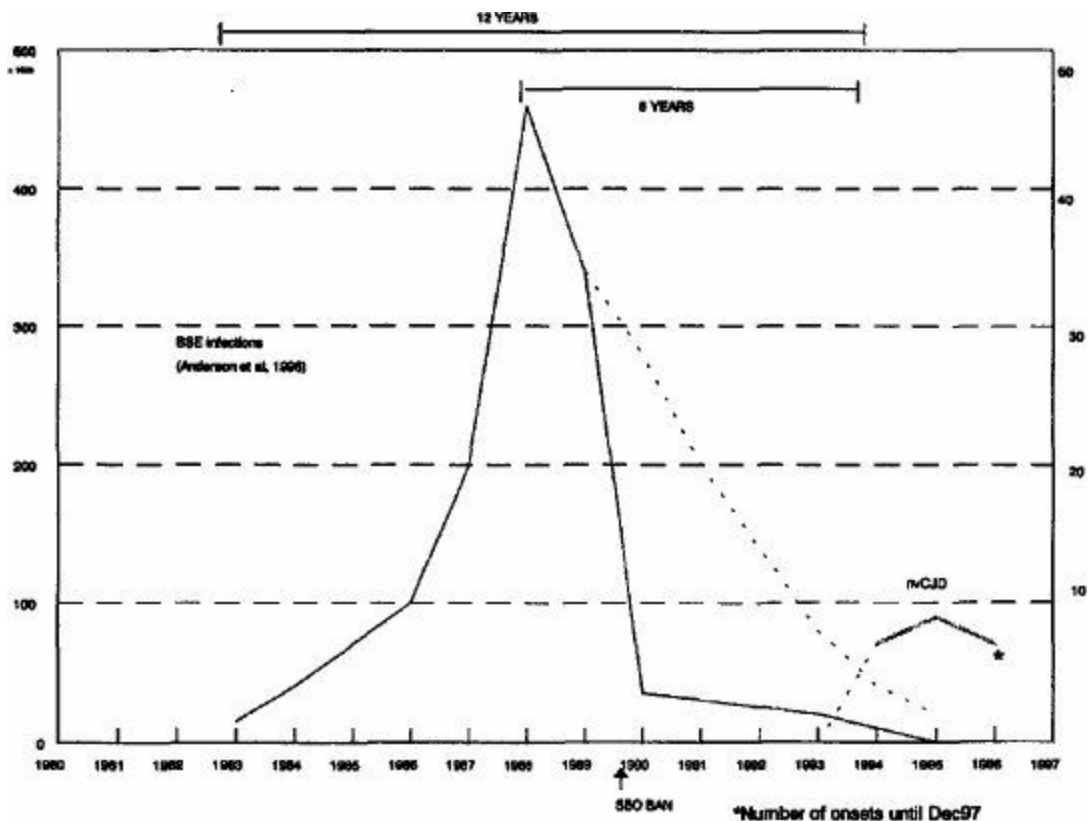

**Figure 2.** BSE ‘exposure’ and incidence of nvCJD (by year of onset).

If exposure to the BSE agent has resulted in a human disease, this disease should occur predominantly in the U.K. since BSE has largely been a disease of British cattle. By October 1996 there had been over 165,000 cases of BSE in the U.K. in comparison to small numbers of cases in other countries: 129 in the Republic of Ireland, 224 in Switzerland, 47 in Portugal, 23 in France, and cases in single figures in Denmark, Germany, Italy, and the Netherlands. Methodologies for CJD surveillance in France, Germany, Italy, the Netherlands, Slovakia, and the U.K. were harmonized in 1993 in order to obtain comparable data and to identify any change in the characteristics of CJD, in particular, any change that might be linked to BSE. Detailed review of clinical and pathological information in March 1996 indicated that no case of nvCJD had been identified in any collaborating country other than the U.K. Since then, 13 further cases of nvCJD have been identified in the U.K. and only one case in continental Europe. This single French case does not refute the hypothetical causal link with BSE as significant quantities of meat products were exported from the U.K. to France in the 1980s as well as cattle and cattle feed. With effective surveillance of CJD in a large proportion of the continental European population and currently no additional cases of nvCJD, it is apparent that nvCJD occurs almost exclusively in the U.K., the country with by far the highest incidence of BSE. This geographical co-localization of BSE and nvCJD provides only circumstantial evidence that the two conditions are linked, but evolving epidemiological evidence reinforces this hypothesis. It would be impossible to interpret the occurrence of nvCJD in the U.K. without comparative data from other countries.

In the study of CJD in the U.K., each suspect case referred while the patient is alive is examined at the referral center and a standardized questionnaire on potential risk factors is

completed by interviewing relatives of the case. In nvCJD there is no past medical history of potential iatrogenic exposure, such as human pituitary hormone therapy. Some cases have undergone surgical procedures, often minor, but with a similar frequency to age-matched control subjects and there is no obvious link with occupational exposures. After identification of the first cases of nvCJD, it was hypothesized that these cases might represent genetic forms of CJD associated with mutation of the prion protein gene (PRNP). Full sequencing of the open reading frame of PRNP, however, has excluded any of the mutations known to be associated with hereditary forms of CJD. All cases tested so far are homozygous for methionine at codon 129 of PRNP, which compares with a similar frequency of this genotype in sporadic CJD [26].

A case-control study of past dietary history has not demonstrated any dietary factor which was consumed more frequently by nvCJD cases in comparison to age-matched controls. The failure thus far to identify a common and distinct dietary factor in nvCJD cases should not be interpreted as refuting a causal link between BSE and nvCJD. There are a number of methodological problems with this type of dietary case-control study. Information on dietary history is necessarily obtained from a surrogate witness, details of past dietary exposures (particularly past years) are known to be unreliable, and there is evidence of respondent bias in previous dietary studies in CJD. Exposure to bovine brain and/or spinal cord in human food may have been intermittent, a range of food products may have contained infectivity, and there may have been variation with time in the level of contamination and the products contaminated. It is possible that single meat products only rarely contained sufficient infectivity to initiate agent replication and subsequent disease. The identification of specific causal exposures may be impossible through the retrospective study of dietary histories years later.

# Conclusion

Analysis of the clinical and pathological features of nvCJD originally suggested that this was a novel disease. The continuing occurrence of cases with a consistent clinico-pathological phenotype and the failure to identify any similar historical case in the U.K. or elsewhere provides strong support for the hypothesis that this is a new form of human spongiform encephalopathy. Exposure to the BSE agent in the 1980s and the appearance of a related human disease in the mid-1990s is consistent with the limited available information on incubation periods in human prion diseases. Cases of nvCJD occur almost exclusively in the U.K., co-localizing with the BSE epidemic. Recent transmission studies of nvCJD in mice have provided strong evidence that there is a causal link between BSE and nvCJD [6].

# References

1. Berger JR, David NJ. Creutzfeldt-Jakob disease in a physician: a review of the disorder in health care workers. *Neurology* 1993;3: 205-6.
2. Brown P, Cathala F, Raubertas RF, Cajdusek DC, Cataigne P. The epidemiology of Creutzfeldt-Jakob disease: Conclusion of a 15-year investigation in France and review of the world literature. *Neurology* 1987;37:895-904.
3. Brown P, Goldfarb L, Gibbs CJ, Gajdusek DC. The phenotypic expression of different mutations in transmissible familial Creutzfeldt-Jakob disease. *European J Epidemiol* 1991;7:469-76.
4. Brown P, Kaur P, Sulima MP, Goldfarb L, Gibbs CJ Jr, Gajdusek DC. Real and imagined clinicopathological limits of "prion dementia". *Lancet* 1993;41:127-9.
5. Brown P, Preece MA, Will RG. 'Friendly fire' in medicine: hormones, homografts, and Creutzfeldt-Jakob disease. *Lancet* 1992;340: 24-7.
6. Bruce ME, Will RG, Ironside JW, et al. Transmissions to mice indicate that 'new variant' CJD is caused by the BSE agent. *Nature* 1997;389:498-501.
7. Chazot G, Broussole E, Lapras CI, Blattler T, Aguzzi A, Kopp N. New variant of Creutzfeldt-Jakob disease in a 26-year old French man. *Lancet* 1996;347:1181.
8. EU Collaborative Study Group for CJD. Descriptive epidemiology of Creutzfeldt-Jakob disease in six European countries 1993-1995. *Ann Neurol*. In press, 1998.
9. Goldberg H, Alter M, Kahana E. The Libyan Jewish focus of Creutzfeldt-Jakob disease: a search for the mode of natural transmission. In: Prusiner SB, Hadlow WJ, editors. *Slow Transmissible Diseases of the Nervous System*. New York: Academic Press; 1979. p.195-211.
10. Goldfarb LG, Brown P, Gajdusek DC. The molecular genetics of human transmissible spongiform encephalopathy. In: Prusiner SB, Collinge J, Powell J, Anderton B, editors. *Prion Diseases of Humans and Animals*. Chichester: Ellis Horwood; 1992. p.139-53.
11. Harries-Jones R, Knight R, Will RG, Cousens S, Smith PG, Matthews WB. Creutzfeldt-Jakob disease in England and Wales, 1980-1984: a case-control study of potential risk factors. *J Neurol Neurosurg Psychiatry* 1988;51:1113-9.
12. Hsiao K, Meiner Z, Kahana E, et al. Mutation of the prion protein in Libyan Jews with Creutzfeldt-Jakob disease. *New Engl J Med* 1991;324:1091-7.
13. Hsiao K, Prusiner SB. Inherited human prion diseases. *Neurology* 1990;40:1820-7.
14. Lo Russo F, Neri G, Figa-Talamanca L. Creutzfeldt-Jakob disease and sheep brain: a report from Central and Southern Italy. *Italian J Neurol Sci* 1980;3:171-4.
15. Masters CL, Harris JO, Gajdusek DC, Gibbs CJ Jr, Bernoulli C, Asher DM. Creutzfeldt-Jakob disease: patterns of worldwide occurrence and the significance of familial and sporadic clustering. *Ann Neurol* 1979;5:177-188.
16. Matthews WB, Will RG. Creutzfeldt-Jakob disease in a lifelong vegetarian. *Lancet* 1981;ii:937.
17. Medori R, Tritschler HJ, LeBlanc A, et al. Fatal familial insomnia, a prion disease with a mutation at codon 178 of the prion protein gene. *New Engl J Med* 1992;326:444-9.
18. Mitrova E, Bronis M. Clusters of CJD in Slovakia: the first statistically significant

- temporospatial accumulations of rural cases. *European J Epidemiol* 1991;7(5):450-6.
19. Palmer MS, Dryden AJ, Hughes JT, Collinge J. Homozygous prion protein genotype predisposes to sporadic Creutzfeldt-Jakob disease. *Nature* 1991;352:340-1.
  20. Pocchiari M, Peano S, Conz A, et al. Combination ultrafiltration and 6-M-urea treatment of human growth hormone effectively minimizes risk from potential Creutzfeldt-Jakob disease virus contamination. *Horm Res* 1991;35(3-4):161-6.
  21. Schellenberg GD, Anderson L, O'Dahl S, et al. APP-717 APP-693 and PRIP gene mutations are rare in Alzheimer's disease. *Am J Hum Genet* 1991;9(3):511-7.
  22. Singhal BS, Dastur DK. Creutzfeldt-Jakob disease in Western India. *Neuroepidemiology* 1983;2:93-100.
  23. Weber T, Tumani H, Holdorff B, et al. Transmission of Creutzfeldt-Jakob disease by handling of dura mater. *Lancet* 1993;341:123-4.
  24. Wilesmith JW, Wells GAH, Cranwell MP, Ryan JB. Bovine spongiform encephalopathy: epidemiological studies. *Vet Rec* 1988;123:638-44.
  25. Will RG, Ironside JW, Zeidler M, et al. A new variant of Creutzfeldt-Jakob disease in the UK. *Lancet* 1996;347:921-5.
  26. Windl O, Dempster M, Estibeiro JP, et al. Genetic basis of Creutzfeldt-Jakob disease in the United Kingdom: a systematic analysis of predisposing mutations and allelic variation in the PRNP gene. *Hum Gen* 1996;98:259-64.



# Iatrogenic Creutzfeldt-Jakob Disease

Paul Brown, M.D.

*National Institute of Neurological Disorders and Stroke, National Institutes of Health,  
U.S.A.*

The iatrogenic variety of Creutzfeldt-Jakob disease (CJD) is a relatively recent addition to the sporadic and familial varieties that have been recognized since the 1920s. All proven or probable iatrogenic cases, now numbering close to 200, have resulted from tissue-penetrating exposure to infected tissues (or their extracts) either within, or directly connected to, the central nervous system. Given the wide bodily distribution of the infectious agent, however, virtually no donor tissue can be exempted from considerations of risk, and it will require constant vigilance to monitor the occurrence of CJD in the recipients of grafts, organ transplants, and tissue extracts used in a vast array of diagnostic and therapeutic agents, including protein concentrates made from human plasma.

# Introduction

Although Creutzfeldt-Jakob disease (CJD) would not appear to qualify as an emerging infectious disease having been recognized for the better part of a century and almost certainly occurring in both its familial and sporadic forms for an untold number of earlier centuries, its iatrogenic variety is a more recent phenomenon that is linked to modern medical technology.

Iatrogenic disease is always unfortunate, and sometimes catastrophic. Public response to it may vary, however, and it is indisputable that the response to iatrogenic CJD has been sensitized to an extraordinary degree by the AIDS epidemic of the past decade. By way of illustration, we may recall that during the 1960s and '70s, transfusion-associated hepatitis caused hundreds, if not thousands, of fatalities, yet passed from the public consciousness with little more than a murmur. This can be compared to the far less consequential transmission of CJD in the 1980s and '90s via contaminated growth hormone and dura mater grafts which created a public outcry with lawsuits in four countries. It also caused many concerned groups, including the United States Congress, to take a lively interest in the mere possibility of transmitting CJD via blood or plasma products, for which there is as yet no known proven example.



# Chronology

The history of iatrogenic CJD is simple. In 1974 and 1977, isolated instances of iatrogenic disease were reported in a patient who had received a corneal graft from a donor who was later discovered to have died of CJD [6] and in two patients who had been subjected to stereotactic electroencephalography with needles previously used to probe a patient with CJD [1]. Retrospective analysis also uncovered a few earlier cases having probably resulted from contaminated neurosurgical instruments. What little interest these cases evoked was limited to the medical community, and public concern about iatrogenic CJD did not occur until 1985, when young hypopituitary patients treated with cadaveric-derived native human growth hormone began dying of CJD [4].

The current tally of pituitary hormone-treated CJD patients stands at slightly more than 100, mostly in residents of the United States, United Kingdom, and France, although cases have also occurred in Scandinavia, Holland, Brazil, and New Zealand (in the latter two countries from hormone prepared in the United States). The risk of acquiring CJD in the United States, United Kingdom, and France is inversely related to the average incubation period elapsing between treatment and the onset of disease, suggesting differing degrees of hormone contamination in each country (shorter incubation periods are usually associated with higher infectious doses) (Table 1). One case of special interest had an incubation period of at least 35 years, which cautions us not to be premature when informing patients with shorter posttreatment intervals that they are out of danger.

**Table 1. Comparison of Cases of Creutzfeldt-Jakob Disease Associated With Cadaveric-derived Human Growth Hormone Therapy in the United States, the United Kingdom, and France**

Country	Number of Patients	Treated Population	Risk of CJD	Mean Incubation Period (years)
United States	22	8500	0.26%	18 ±6
United Kingdom	26	1750	1.49%	14 ±3
France	53	1700	3.12%	8 ±3

Shortly after the first growth hormone cases were recognized, the first case of iatrogenic disease from contaminated dura mater was reported [8]. It is probable that this association would not have been made without the comparatively brief interval (18 months) between placement of the graft and the onset of CJD — later cases have had incubation periods of up to 16 years. Until recently, the accumulated number of reported dura mater cases has leveled off at 25, occurring randomly or in hospital clusters in several different countries, and almost all the result of Lyodura® grafts collected, processed, and distributed by B. Braun-Melsungen between the years 1982 and 1987. The Japanese have now tripled this total, however, with a report of 43 additional Lyodura cases occurring over a several year period [5], so that the grand total now stands at 68.

# Host and Invader

To some extent, both the incubation period and clinical presentation of iatrogenic CJD appear to depend on the route of infection (Table 2). When introduced directly into the brain (or via the optic nerve), incubation times are short and the clinical onset is indistinguishable from that of sporadic CJD (which presumably also begins inside the brain). When introduced onto the surface of the brain, incubation times are variable and the clinical onset can be similar to sporadic CJD or have a predominantly cerebellar character. Introduction from the periphery results in much longer incubation times, and CJD presents almost exclusively as a cerebellar disorder with little, if any, dementia appearing only later in the course of illness.

**Table 2. Cases of Iatrogenic Creutzfeldt-Jakob Disease Grouped According to the Source of Infection**

Mode of Infection	Number of Patients	Agent Entry into Brain	Mean Incubation Period (range)	Clinical Presentation
Corneal transplant	2	Optic nerve	17 mos (16-18)	Dementia/Cerebellar
Stereotactic EEG	2	Intracerebral	18 mos (16-20)	Dementia/Cerebellar
Neurosurgery	4	Intracerebral	20 mos (15-28)	Visual/Dementia/Cerebellar
Dura mater graft	68	Cerebral surface	3.5 yrs (1.5-16)	Cerebellar (Visual/Dementia)
Gonadotrophin	4	Hematogenous	13 yrs (12-16)	Cerebellar
Growth hormone	103	Hematogenous	12 yrs (5-30)	Cerebellar

Experimentally-inoculated primates of any given species (including chimpanzees) show no apparent individual differences in susceptibility to infection; thus, it was surprising to discover that humans with iatrogenic CJD appear to have a genetically-mediated susceptibility to the disease. The amyloid-encoding PrP gene on chromosome 20 contains a polymorphic codon (129) that is homozygous in 90% of iatrogenic CJD patients, but in only 50% of the general population (Table 3). Review of the genotype in patients having different routes of infection, however, suggests that the polymorphism may influence only peripherally-infected cases, raising the possibility that direct intracerebral infection either short circuits or overwhelms any genetic determinants [3].

# Potential Dangers: Tissues and Tissue Extracts

To date, iatrogenic CJD has been limited to transmission from tissue within or directly connected to the central nervous system (CNS). The pathogenic agent is widespread in the bodies of infected individuals, however, and even though present in vastly lower concentrations than in the CNS, still poses a potential threat of transmission to recipients of all manner of allografts and biologicals prepared from human tissues. A few cases of CJD have been reported in patients who had pericardial or bone grafts, or kidney or liver organ transplants prior to disease. In none of these instances, however, was the donor identified as having had CJD; thus, the iatrogenic origin of these cases must still be considered conjectural. Given the susceptibility of many animals other than humans to spongiform encephalopathies, even xenografts and animal tissue extracts cannot be dismissed from consideration. Biologicals that have come to our attention include CNS gangliosides of either human or bovine origin, and a wide variety of products that, while not suspect in themselves, may be exposed to culture media or protein broths containing small amounts of animal or human tissue extracts. Continued vigilance will be required to track down and investigate anecdotal instances of CJD occurring in recipients of such products.

**Table 3. Codon 129 PrP Genotypes in Different Case Groups of Iatrogenic Creutzfeldt-Jakob Disease**

Tested Groups	Codon 129 Genotype			
	Met/Met	Met/Val	Val/Val	Homozygous
<b>CNS Route of Infection</b>				
Stereotactic-EEG electrode	1	1	0	1/2
Neurosurgery	1	1	0	1/2
Corneal graft	1	0	1	2/2
Dura mater graft	13	0	1	14/14
CNS subtotal	16	2	2	18/20 (90%)*
<b>Peripheral Route of Infection</b>				
Human gonadotrophin	2	1	1	3/4
Human growth hormone	20	4	15	35/39
Peripheral subtotal	22	5	16	38/43 (88%)*
<b>All Iatrogenic Cases</b>	38	7	18	56/63 (89%)*
<b>Normal Controls</b>	97	135	29	126/261 (48%)

\* P = <0.001 compared to normal controls (Chi square test).

# Potential Dangers: Blood and Blood Products

Of great current concern is the question of whether or not blood and plasma products may be vehicles for the iatrogenic transmission of CJD. To date, there have been no proven instances of such transmissions, either in national systematic CJD surveillance or multinational case-control studies, and even high-risk groups such as hemophiliacs have yet to post a single case. It can, therefore, be concluded with some confidence that the administration of therapeutic blood products is not a numerically important cause of CJD. The inherent limitation in these types of studies, however, is that rare cases might actually be occurring and will not be detected because they will not be numerous enough to break through the threshold of statistical significance. Therefore, we cannot say with equal confidence that CJD may not occasionally be transmitted by blood.

Consequently, we are extremely interested in any experimental evidence exhibiting the potential for infectivity to be present in blood, even if it cannot be proven that blood has actually been responsible for a human case of CJD. A great deal of information regarding blood infectivity in various scrapie and CJD experimental rodent models has been accumulated, as well as some data regarding blood infectivity in naturally-infected animals and humans [2]. Together, the studies clearly indicate that in experimentally-infected rodents, infectivity is often detectable in the blood, usually (but not exclusively) in association with its buffy coat component, and that in human CJD patients, blood infectivity may also occur but with much less regularity.

We have recently examined the distribution of infectivity in the various blood components and plasma fractions of 1) normal human blood that had been 'spiked' with a brain cell suspension from scrapie-infected hamsters, and 2) pooled blood of mice infected with a mouse-adapted strain of human spongiform encephalopathy. The results of both experiments (Figure 1 and Table 4) were consistent in verifying that buffy coat is infectious; that a small amount of infectivity is also detectable in plasma; and that plasma infectivity is almost entirely brought down in the first two steps of the Cohn fractionation process that yield cryoprecipitate (the source of antihemophilic factor) and Fraction I+II+III (the source of immune globulin). The last two steps that yield Fractions IV and V (the source of fibrinogen and albumin) were virtually or entirely devoid of infectivity.

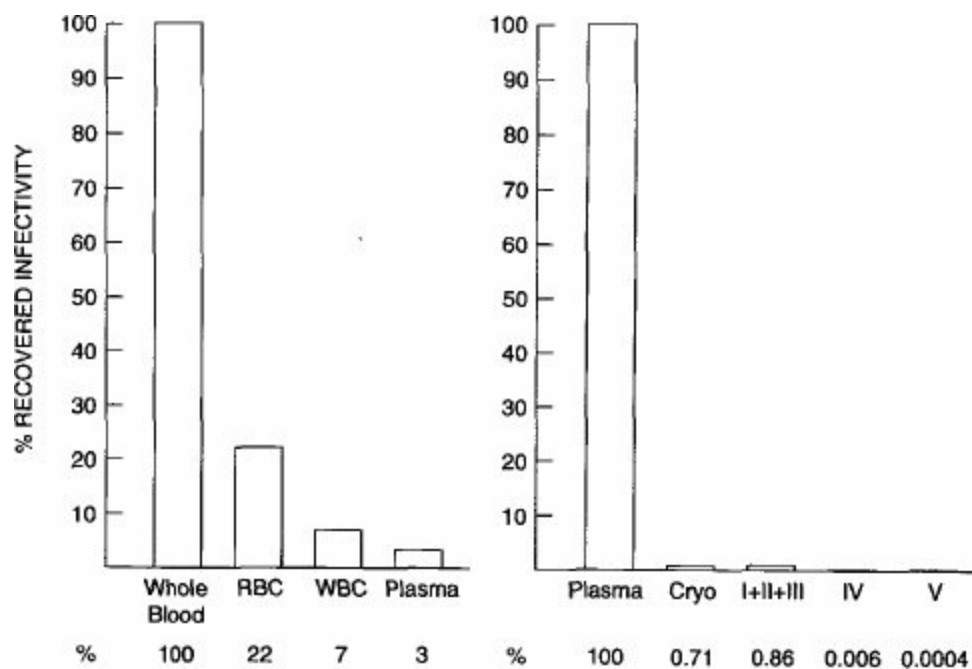

**Figure 1.** Distribution of infectivity in the various blood components and plasma fractions in normal human blood ‘spiked’ with a brain cell suspension from scrapie-infected hamsters and then separated and fractionated according to a widely-used commercial protocol. The left graph compares the amount of infectivity in whole blood (set at 100%) to the amounts of infectivity recovered in components. The right graph compares the amount of infectivity in plasma (reset to 100%) to the amount of infectivity recovered in plasma fractions.

**Table 4. Infectivity in Blood Components and Plasma Fractions Processed from 45 mL of Pooled Blood from Mice Experimentally-infected With a Mouse Adapted Strain of Human Spongiform Encephalopathy<sup>a</sup>**

Specimen	Proportion of Specimen Inoculated (%)	Specimen Dilution	Positive Animals	Negative Animals
Whole blood	0.15	1:5	0	11
Red cells	0.22	1:5	0	7
Buffy coat <sup>b</sup>	2.3	1:5	2	10
Plasma pellet <sup>c</sup>	60	1:6	4	19
Plasma	3.5	1:5	8	124
Cryoprecipitate <sup>d</sup>	29	1:4	5	6
Fx I+II+III	37	1:4.5	6	37
Fx IV <sub>1</sub> +IV <sub>4</sub>	38	1:4	0	86
Fx V	30	1:4	0	94

<sup>a</sup> Specimens were assayed by intracerebral inoculation of healthy weanling mice.

<sup>b</sup> Sliced from top 5 mm of red cell sediment frozen after centrifugation of whole blood.

Infectivity was probably higher than shown, as several animals dying at about the same time were not verified as CJD-related.

<sup>c</sup> Pellet from plasma centrifugation.

<sup>d</sup> One of four animals was also positive at a 1:40 dilution.

The very low to absent infectivity of the albumin-containing fraction is of special importance because albumin is used not only as a therapeutic product *per se*, but also as an excipient or 'stabilizer' in many other plasma protein concentrates. It is also used in a surprisingly diverse array of nonplasma derived products, including such things as injectable radiology dyes and tissue culture maintenance media for *in vitro* embryo fertilization procedures.

These results have generated a number of further experiments in rodents and nonhuman primates designed to answer the following questions: 1) what is the distribution of infectivity in blood components and plasma fractions during the preclinical incubation phase of disease; 2) what specific cell type or types carry the infectivity present in buffy coat (B-cells have recently been implicated in neuroinvasion and clinical disease in scrapie-infected mice) [7]; 3) what is the origin of the infectivity present in plasma, i.e., is it due to intact or fragmented cell contamination, or is it 'free-floating' and unassociated with cellular membranes; and 4) what is the likelihood that blood infectivity that is detectable by intracerebral inoculation may also be detected when assayed by intravenous inoculation. Finally, the question of biological distinctiveness of the 'new variant' CJD resulting from infection by the agent of bovine spongiform encephalopathy is under active investigation with respect to blood infectivity.

When finally assembled in the course of the next year or two, information from these experiments should provide a rational basis for regulatory policy decisions regarding the safety of blood products, and verify whether the millions of dollars lost because of product recalls has been justified and prudent or merely wasteful.

# References

1. Bernoulli C, Siegfried J, Baumgartner G, et al. Danger of accidental person-to-person transmission of Creutzfeldt-Jakob disease by surgery. *Lancet* 1977;i:478-9.
2. Brown P, Gajdusek DC, Gibbs CJ Jr, Asher DM. Potential epidemic of Creutzfeldt-Jakob disease from human growth hormone therapy. *N Engl J Med* 1985;313:728-31.
3. Brown P. Can Creutzfeldt-Jakob disease be transmitted by transfusion? *Curr Opin Hematol* 1995;2:472-7.
4. Brown P. Environmental causes of human spongiform encephalopathy. In: Baker HF, Ridley RM, editors. *Methods in Molecular Medicine: Prion Diseases*. Totowa (NJ): Humana Press; 1996. p. 139-54.
5. CDC. Creutzfeldt-Jakob disease associated with cadaveric dura mater grafts – Japan, 1997. *MMWR Morb Mortal Wkly Rep* 1997;46:1066-9.
6. Duffy P, Wolf J, Collins G, Devoe A, Streeten B, Cowen D. Possible person-to-person transmission of Creutzfeldt-Jakob disease. *N Engl J. Med* 1974;290:692.
7. Klein MA, Frigg R, Flechsig E, et al. A crucial role for B cells in neuroinvasive scrapie. *Nature* 1997;390:687-90.
8. Thadani V, Penar PL, Partington J, et al. Creutzfeldt-Jakob disease probably acquired from a cadaveric dura mater graft. *J Neurosurg* 1988;69:766-9.





# **Inactivation of the Causal Agents of Transmissible Spongiform Encephalopathies**

David M. Taylor, Ph.D.

*BBSRC & MRC Neuropathogenesis Unit, Institute for Animal Health, U.K.*

# Introduction

Over the last three decades, a variety of fatal neurological diseases of animals and humans have been consolidated into a single group that can be described as transmissible degenerative encephalopathies (TDE) or transmissible spongiform encephalopathies (TSE). These conditions, shown in Table 1, include bovine spongiform encephalopathy (BSE), scrapie in sheep (also in goats and moufflon), and Creutzfeldt-Jakob disease (CJD) in humans. A unifying feature of these diseases is that, as a consequence of infection, a normal host protein ( $\text{PrP}^{\text{C}}$ ) is converted to a form ( $\text{PrP}^{\text{Sc}}$ ) that is relatively resistant to degradation by proteolytic digestion, and consequently accumulates within the host. The highest expression levels of  $\text{PrP}^{\text{C}}$  are within the central nervous system, where the pathological accumulation of  $\text{PrP}^{\text{Sc}}$  is most evident and is usually accompanied by spongiform encephalopathy. Although these diseases are commonly described as TSE, spongiform encephalopathy is not a universal feature; however, there is always histopathological evidence of neurodegeneration. For this reason, the term 'TDE' has been considered to be more appropriate than 'TSE' [41].

**Table 1. Transmissible Degenerative Encephalopathies**

Disease	Affected Species
Scrapie	Sheep, Goats, Moufflon
Transmissible Mink Encephalopathy	Mink
Chronic Wasting Disease	Elk, Mule-deer
Bovine Spongiform Encephalopathy	Cattle, Captive exotic ruminants
Feline Spongiform Encephalopathy	Domestic cats, Captive exotic felids
Creutzfeldt-Jakob Disease	Humans
Gertsman-Straussler-Scheinker Syndrome	Humans
Kuru	Humans
Fatal Familial Insomnia	Humans

A prominent theory is that the transmissible agents consist of nothing more than  $\text{PrP}^{\text{Sc}}$  (perhaps accompanied by another host-specific accessory protein) which, when introduced into a new host, can cause disease by acting as a template for the conversion of  $\text{PrP}^{\text{C}}$  to  $\text{PrP}^{\text{Sc}}$  [31,32]. There is generally no fundamental disagreement with the idea that  $\text{PrP}^{\text{Sc}}$  is at least a component of such agents. There is a body of opinion [1,8,9,17], however, that the 'protein-only' hypothesis cannot adequately explain the variety of phenotypic characteristics of different strains of scrapie agent in mice of the same *PrP* genotype, or the remarkable phenotypic stability of the BSE agent in mice, regardless of whether transmission is directly from cattle to mice, or via intermediate species such as kudu, nyala, domestic cats, pigs, sheep, goats, and even humans [6,7].

Regardless of their precise molecular nature, it has been recognized for more than 50 years that TDE agents are relatively resistant to inactivation by procedures that are known

to be effective with conventional microorganisms.

# Accidental Transmission Through Failure of Inactivation Procedures

The difficulty of inactivating TDE agents first became apparent when about 1,800 of 18,000 sheep that had been vaccinated against louping-ill virus developed scrapie. The vaccine had been contaminated unsuspectedly with scrapie agent which survived the exposure to 0.35% formalin that inactivated the louping-ill virus [24].

The use of decontamination methods retrospectively recognized as being inappropriate has resulted in the accidental transmission of CJD. In one instance, two electrodes used for insertion into the brain for diagnostic purposes caused iatrogenic infection. After use on a patient with suspected CJD, the electrodes were 'sterilized' by exposure to ethanol and formaldehyde vapor. Because the inadequacy of this 'sterilization' process for inactivating CJD agent had not been recognized, the 'sterilized' electrodes transmitted CJD through their insertion into the brain of two subsequent patients requiring similar neurological investigation [4]. Convincing evidence that these electrodes were responsible for these iatrogenic CJD episodes was provided by the production of a CJD-like disease in a chimpanzee in which the suspect electrodes were implanted into the brain [22].

A standard hot air sterilization process (180°C for 2 hours) was also considered to have failed to decontaminate CJD-contaminated surgical instruments which subsequently transmitted the disease to a patient during brain surgery [19].

It is generally considered that BSE was caused by the transmission of scrapie agents to bovines via foodstuff [14,52]. Prior to the ban in the United Kingdom in July 1988, it was common practice to incorporate ruminant-derived meat and bone meal into the diets of dairy cattle. It is now known that the heating process used in many of the rendering procedures traditionally used to manufacture meat and bone meal do not completely inactivate BSE or scrapie agents [48,49,51].

# TDE Inactivation Studies

Although the precise molecular nature of TDE agents is unknown, this has not prevented the conduct of meaningful studies relating to their inactivation under conditions that are directly relevant to everyday practice in hospitals, laboratories, rendering plants, and facilities for manufacturing biopharmaceutical products.

Despite the recognized relative resistance of TDE agents to inactivation, it was considered that two major studies carried out during the 1980s had identified a small number of reliable procedures. The work of Kimberlin *et al.* [26] showed that two strains of mouse-passaged scrapie agents were completely inactivated by exposure for 30 minutes to solutions of sodium hypochlorite containing 13,750 ppm of available chlorine. It was therefore proposed that exposure for 1 hour to a solution of sodium hypochlorite containing 20,000 ppm available chlorine should be a reliable inactivating procedure. In the same study, previously described differences in the thermostability of mouse-passaged strains of scrapie agent were confirmed [13]. Although strain 139A was completely inactivated by exposure to gravity-displacement (GD) autoclaving at 126°C for 2 hours, strain 22A was not. A 4-hour exposure was required to inactivate 22A under these conditions [11]. However, the studies of Kimberlin *et al.* [26] also showed that porous-load (PL) autoclaving at 136°C for 4 minutes was completely effective with both of these strains of scrapie agent.

These latter data were used to formulate the recommendations in the United Kingdom that PL autoclaving at 134 to 138°C for 18 minutes should be used to inactivate CJD-contaminated materials [10]. Nevertheless, it was recommended that instruments used in surgery involving the brain, spinal cord, or eyes of known or suspected cases of CJD should be discarded rather than recycled after autoclaving. This advice was later extended to include other categories of patients recognized to have a higher risk of developing CJD. Specifically, these were defined as blood relatives of families with a known predisposition to TDE and individuals who had been recipients of a) hormones derived from the pituitary glands of human cadavers, b) dura mater graft material derived from human cadavers, or c) human corneal grafts. The continuing advice not to recycle surgical instruments after they had been used in neurosurgical or ophthalmological procedures was no doubt based upon the knowledge that, despite the apparent reassurance regarding the effectiveness of PL autoclaving in the 1983 autoclaving study, doubt remained concerning the general effectiveness of autoclaving with TDE agents. It was clear therefore, that future studies might reveal inadequacies in the standards adopted in 1984 for inactivating CJD agent by PL autoclaving and, as will be discussed further in this paper, this proved to be the case.

The main conclusions from the second major inactivation study carried out in the 1980s [5] were that rodent-passaged CJD and scrapie agents could be inactivated by exposure to 1M sodium hydroxide for 1 hour, or GD autoclaving at 132°C for 1 hour. These procedures have been incorporated into formal recommendations on how to deal with TDE infectivity [e.g., 18,36]. Further studies have shown, however, that GD autoclaving at 132°C for 1 hour does not completely inactivate scrapie agent [16,30,44]. As will be discussed, this is also the case for the recommended 1M sodium hydroxide treatment.

Although the incidence of BSE in Britain during the mid-1980s was relatively modest, the

notification rate rapidly increased as time progressed and became a matter of concern. It was therefore considered prudent to compare the resistance to inactivation of the BSE agent with that of scrapie agent. These studies showed that the already recommended procedure for achieving inactivation by exposure for 1 hour to sodium hypochlorite solutions containing 20,000 ppm available chlorine was effective with the BSE agent [47]. However, solutions of sodium dichloroisocyanurate containing the same range of concentrations of available chlorine that proved effective when sodium hypochlorite was used were not effective because they were more reluctant to release their available chlorine content [47].

In the study of Brown *et al.* [5] which reported that treatment for 1 hour with 1M sodium hydroxide inactivated CJD and scrapie agents, the sensitivity of the bioassays was reduced because it proved necessary to dilute the samples to render them nontoxic for the recipient animals. Other reports have recorded the detection of residual scrapie infectivity after treatment with 1M sodium hydroxide for either 1 hour [15,16] or 24 hours [33]. There are also other reports on the survival of CJD infectivity after exposure to 1M or 2M sodium hydroxide [39]. More recent work with sodium hydroxide involving the BSE agent and two strains of scrapie agent has demonstrated that if the pH of the samples is carefully neutralized, they can be injected into the assay animals with further dilution, thus enhancing the sensitivity of the bioassay [47]. Under these circumstances, infectivity can be shown to survive exposure to 2M sodium hydroxide for up to 2 hours. With the 263K strain of scrapie agent, although more than five logs of infectivity were inactivated during such treatments, approximately four logs survived [47].

With regard to PL autoclaving, the new studies cast doubt on the reliability of the existing standard (134 to 138°C for 18 minutes) because BSE agent and two strains of rodent-passaged scrapie agent survived exposure to such PL cycles [47]. The average mass of the infected brain macerates used in the more recent study, however, was 340 mg [47], compared with 50 mg used in the earlier study [26]. The decision to use the larger volumes of macerates of infected brain tissue was based upon the knowledge that, with similarly sized samples of intact (but not macerated) brain tissue, inactivation had been previously achieved by the 134 to 138°C PL autoclaving procedures [40,44,46]. In addition, it was considered that the larger sample sizes might more realistically represent the actual mass of TDE-infected tissue that might need to be disposed by autoclaving during human and veterinary health care; however, no official advice has ever been issued in this respect.

In view of the uncertainties relating to PL autoclaving introduced by the studies of Taylor *et al.* [47], further experiments were carried out to assess the effectiveness of PL autoclaving cycles at 134, 136, and 138°C for times ranging from 9 to 60 minutes using samples of infected brain macerates weighing either 50 mg or 375 mg. The agents used were a) 22A, a mouse-passaged strain of scrapie agent that is known to be more thermostable than other strains of mouse-passaged scrapie agent [13,26]; b) 263K, a hamster-passaged strain of scrapie agent that had more recently been shown to survive PL autoclaving [47]; and c) 301V, a mouse-passaged strain of BSE agent that had not been previously tested. The data from these experiments [Taylor, unpublished data] indicated that 301V could survive exposure to 138°C for 1 hour. However, 50-mg macerates of 22A-infected brain tissue in which the infectivity levels were  $\geq 10^{7.2}$  ID<sub>50</sub> were inactivated by all of

the 136°C processes, in accordance with earlier data [26]. The same was true for the 50-mg macerates exposed for four different time periods at 134°C. Paradoxically, one case was observed in mice injected with material from a 50-mg sample autoclaved at 138°C for 9 minutes. This might have been written off as an experimental aberration had it not been that positive cases were also observed in mice injected with material from 375-mg macerates autoclaved at 136°C or 138°C (but not at 134°C). These data suggest that the thermostability of the 22A strain became enhanced as the autoclaving temperature increased, and the difference between the 134°C and 138°C samples was statistically significant ( $p < 0.01$ ). With 263K, the starting titre was  $10^{8.3}$  ID<sub>50</sub>/g, and there was much the same degree of survival of the agent whether autoclaving was carried out at 134, 136, or 138°C. This also supports the above hypothesis concerning the relationship between thermostability and autoclaving temperature. For 301V which had a starting titre of  $10^{8.6}$  ID<sub>50</sub>/g, the data are even more convincing in this respect. Sixty percent of the animals that were injected with material autoclaved at 134°C developed disease; the ratio for similar samples exposed at 138°C was 72%. This difference was statistically significant ( $p < 0.05$ ). These data indicate that simply increasing PL autoclaving temperatures and holding times would not necessarily be effective in achieving a reliable decontamination standard for inactivating TDE agents by autoclaving. These data could have been open to question had it not been that the efficiency of the autoclave and the steam generator were checked by an independent agency before, during, and after the experimental autoclaving cycles, and that each experimental cycle was monitored independently through the use of thermocouples by this agency.

# Combining Autoclaving with Exposure to Sodium Hydroxide

Although autoclaving or exposure to sodium hydroxide *per se* do not completely inactivate TDE agents, inactivation can apparently be achieved by combining these procedures. Taguchi *et al.* [38] and Ernst and Race [16] described the successful inactivation of CJD and scrapie infectivity, respectively, by a sequential process involving exposure to 1M sodium hydroxide, followed by GD autoclaving at 121°C for 30 or 60 minutes, respectively. Complete inactivation of 263K has also been reported after GD autoclaving at 121°C for 90 minutes in the presence of 1M sodium hydroxide [33]. More recently, it has been observed that if 22A is autoclaved at 121°C for 30 minutes in the presence of 2M sodium hydroxide (without a prior holding period in sodium hydroxide), inactivation can be achieved [50]. There are practical problems relating to this procedure such as the potential exposure of operators to splashing with sodium hydroxide, and the eventual deleterious effect of sodium hydroxide contamination on the autoclave chamber and other components. Given the shortage of other reliable decontamination strategies for TDE agents, it may be profitable to develop this system by eliminating the practical difficulties that are associated with it at present. In this respect it would be desirable to contain contaminated materials in sealed, heat-resistant containers that can withstand steam at 1 bar above atmospheric pressure. This would minimize the risk to the operator of contact with sodium hydroxide resulting from spillage, and would also avoid damage to the autoclave that might occur as a result of contact with the hydroxide. There is no reason why hydroxide-treated waste should not be processed alternatively in PL autoclaves, provided that the containers used are able to withstand the higher pressures customarily involved, plus the high vacuum stages that are a feature of PL autoclaving.



# Observations on the Thermostability of TDE Agents

The enhanced capacity of TDE infectivity to survive PL autoclaving when exposed as tissue macerates compared with intact tissue has already been discussed. A likely explanation for this observation is that, in using brain macerate sample sizes as large as 340 mg, there was some smearing and drying of the brain tissue onto the surfaces of the glass containers before autoclaving. It has been previously reported that scrapie agent is more resistant to inactivation by autoclaving when infected brain tissue becomes dried onto glass or metal surfaces [2,3].

When scrapie agent is completely inactivated by autoclaving, destruction of the agent over time proceeds in an exponential fashion [35]. If the amounts of infectivity remaining after increasing exposure times, through to the time when complete inactivation is achieved, are plotted on a logarithmic scale a straight line is obtained which shows that the death-rate is constant. In marked contrast, when a heating procedure is only partially inactivating, a tailing-type of inactivation curve results, which shows an initial decline and then flattens and persists with time [35]. After autoclaving at 134 to 138°C for 18 minutes, it has been shown that the amount of BSE or scrapie infectivity that survives is relatively constant regardless of the starting titre or whether the agents are present in bovine, hamster, or mouse brain [43]. An example of the tailing-type of inactivation curve referred to above can be derived from data [47] relating to the inactivation of the 263K strain of scrapie agent by autoclaving. If, as is often the practice with conventional microorganisms, the initial steep decline in infectivity is used to predict the time that it will take to achieve complete inactivation, the results are a gross underestimate for 263K. This reinforces the viewpoint (relating to conventional microorganisms) that, although such estimates may often be useful and sometimes accurate, there is no substitute for establishing full inactivation curves [23]. Tailing inactivation curves are not uncommon for conventional microorganisms. These may result from the protective effect of aggregation during the inactivation process, or may be due to population heterogeneity where differing straight-line inactivation curves for two or more subpopulations combine to produce a tailing curve. Where there is no population heterogeneity, the same sort of tailing curve is still usually obtained when the surviving organisms are recultured and retested [21]. One explanation for the presence of heat- or chemical-resistant subpopulations of scrapie agent might be the protective effect of aggregation which could occur in homogenates of infected tissue but not in undiluted tissue. This argument has been invoked to explain why 2% peracetic acid apparently inactivated the scrapie infectivity in intact scrapie-infected mouse brain but not in 10% homogenates of brain tissue [42].

Although more than seven logs of infectivity were lost, two logs of 263K infectivity in 340-mg samples of macerated hamster brain survived autoclaving at 134°C for 1 hour [47]. As has already been discussed, similarly-sized samples of infected brain tissue are completely decontaminated within 18 minutes by autoclaving if the brain tissue is undisrupted; the lower efficiency of inactivating macerates may result from the fact that some smearing and drying before autoclaving occurs with this type of sample [2,3]. As will be discussed further, a possible explanation for this phenomenon is that PrP<sup>Sc</sup> in the thin,

smear, and dried portion of the tissue macerates becomes rapidly heat-fixed, and consequently more resistant to inactivation by the autoclaving process.

It has now been shown that a relatively heat-resistant subpopulation of scrapie agent retains its thermostability when reheated, suggesting that this is an acquired but stable characteristic that differentiates it from the main population of scrapie agent. After one PL autoclaving cycle at 134°C for 18 minutes, the titre of 263K was reduced by 5.7 logs. However, the titre was reduced by only a further 1.3 logs after autoclaving for a second time [Taylor, unpublished data]. Evidence for the intrinsic and fundamental difference of this heat-resistant subpopulation comes from the fact that, at its limiting dilution, it produces an average incubation period in recipient animals that is well beyond that for unheated material at its limiting dilution [45]. Under defined experimental conditions, specific strains of scrapie in rodents display reproducible inverse relationships between the dose of infectivity administered and the subsequent incubation period before onset of the clinical signs [29]. For any given model, the amount of infectivity present in an inoculum can be calculated by comparing the incubation period of the recipients with an 'incubation period assay' graph, without the need for titration. Unfortunately, this procedure cannot be applied to infectivity exposed to chemical or physical treatments because these can radically extend the dose-response curves for a treated versus an untreated agent [45]. The same conclusions have been arrived at as a result of other studies involving chemical or physical treatment of scrapie agent [12,25,27,37,48]. This means that a meaningful assessment of the amount of infectivity remaining after exposure to partially inactivating procedures can only be obtained by full titration, and by observing the assay animals for extended periods [29]. In one instance [34], the calculation of residual titre by incubation period assay was found to be up to 4,000-fold less than the true titre when measured by bioassay [45]. This problem is still not always appreciated, and there are still ongoing inactivation studies in which the titre of surviving infectivity is being estimated by incubation period analysis [28].

The lesser efficiency of inactivating partially smeared and dried macerated tissue, compared with intact undisrupted tissue, may relate to the very rapid heating that would occur in the film of dried material (compared with the bulk of the sample), with a consequently very rapid fixation of PrP<sup>Sc</sup> in the dried film. Protection by fixation has been shown to occur during the inactivation of polio virus by formalin [20]. Prior fixation in ethanol [44] or formalin [46] has been shown to considerably enhance the thermostability of the scrapie agent. It has also been observed that the amount of scrapie infectivity inactivated after 4 hours under vacuum at 72°C is greater than that achieved using the same equipment over the same timescale at atmospheric pressure when an end-temperature of 120°C is achieved [51]. Because the molecular nature of TDE agents has not yet been definitively characterized, it is difficult to know with any certainty what accounts for the characteristics of the subpopulations of scrapie agent that are intrinsically more thermostable than the main population. Given that PrP<sup>Sc</sup> is a likely component of TDE agents, however, the data suggest that procedures which produce rapid and/or extremely effective fixation of PrP<sup>Sc</sup> result in enhanced resistance of such agents. This is also supported by the data that have already been discussed which show enhanced survival of 22A and 301V during autoclaving at 138°C compared with 134°C. The practical implication of these collective data is that

decontamination procedures that do not involve protein-fixation may prove to be more effective than procedures that do.

# References

1. Almond J, Pattison J. Human BSE. *Nature* 1997;389:437-8.
2. Asher DM, Pomeroy KL, Murphy L, Rohwer RG, Gibbs CJ, Gajdusek DC. Practical inactivation of scrapie agent on surfaces. Abstracts of the IXth International Congress of Infectious and Parasitic Diseases; 1986 July 20-26; Munich, Germany.
3. Asher DM, Pomeroy KL, Murphy L, Gibbs CJ, Gajdusek DC. Attempts to disinfect surfaces contaminated with etiological agents of the spongiform encephalopathies. Abstracts of the VIIth International Congress of Virology, 1987 August 9-14; Edmonton, Canada. p. 147.
4. Bernoulli C, Siegfried J, Baumgartner G, et al. Danger of accidental person-to-person transmission of Creutzfeldt-Jakob disease by surgery. *Lancet* 1977;ii:478-9.
5. Brown P, Rohwer RG, Gajdusek DC. Newer data on the inactivation of scrapie virus or Creutzfeldt-Jakob disease virus in brain tissue. *J Infect Dis* 1986;153:1145-8.
6. Bruce ME, Chree A, McConnell I, Foster J, Pearson G, Fraser H. Transmission of bovine spongiform encephalopathy and scrapie to mice; strain variation and the species barrier. *Philos Trans R Soc Lond B* 1994;343:405-11.
7. Bruce ME, Will RG, Ironside JW, et al. Transmissions to mice indicate that 'new variant' CJD is caused by the BSE agent. *Lancet* 1997;389:498-501.
8. Chesebro B. BSE and prions: Uncertainties about the agent. *Science* 1998;279:42-3.
9. Coles H. Nobel panel rewards prion theory after years of heated debate. *Nature* 1997;389:529.
10. DHSS. Management of patients with spongiform encephalopathy Creutzfeldt-Jakob disease (CJD). DHSS Circular DA 1984;84:16.
11. Dickinson AG. Scrapie in sheep and goats. In: Kimberlin RH, editor. *Slow Virus Diseases of Animals and Man*. Amsterdam: North Holland; 1976. p. 209-41.
12. Dickinson AG, Fraser H. Modification of the pathogenesis of scrapie in mice by treatment of an agent. *Nature* 1969;222:892-3.
13. Dickinson AG, Taylor DM. Resistance of scrapie agents to decontamination. *N Engl J Med* 1978;229:1413-4.
14. Dickinson AG, Taylor DM. Options for the control of scrapie in sheep and its counterpart in cattle. *Proceedings of the Third World Congress on Sheep and Beef Cattle Breeding*; 1988 Jun 19-23. Vol. 1; p. 553-64.
15. Diringier H, Braig HR. Infectivity of unconventional viruses in dura mater. *Lancet* 1989;1:439-40.
16. Ernst DR, Race RE. Comparative analysis of scrapie agent inactivation. *J Virol Methods* 1993;41:193-202.
17. Farquhar CF, Somerville RA, Bruce ME. Straining the prion hypothesis. *Nature* 1998;391:345-6.
18. Federal Ministry of Health. Guidelines on safety measures in connection with medical products containing body materials obtained from cattle, sheep or goats minimizing the risk of transmission of BSE or scrapie. *Federal Bulletin* February 1994; no. 40.
19. Foncin JF, Gaches J, Cathala F, El Sherif E, Le Beau J. Transmission iatrogene

- interhumaine possible de maladie de Creutzfeldt-Jakob avec atteinte des grains du cervellet. *Rev Neurol (Paris)* 1980;136:280.
20. Gard S, Maaloe O. Inactivation of viruses. In: Burnet FM, Stanley WM, editors. *The Viruses*. Vol. 1. New York: Academic Press; 1959. p. 359-427.
  21. Gardner JF, Peel MM, editors. *Introduction to Sterilization, Disinfection and Infection Control*. Edinburgh: Churchill Livingstone; 1991.
  22. Gibbs CJ, Asher DM, Kobrine A, Amyx HL, Sulima MP, Gajdusek DC. Transmission of Creutzfeldt-Jakob disease to a chimpanzee by electrodes contaminated during neurosurgery. *J Neurol Neurosurg Psychiatry* 1994;57:757-8.
  23. Greene VW. Sterility assurance: Concepts, methods and problems. In: Russell AD, Hugo WB, Ayliffe GAJ, editors. *Principles and Practice of Disinfection, Preservation and Sterilization*. Oxford: Blackwell; 1992. p. 605-24.
  24. Greig JR. Scrapie in sheep. *J Comp Pathol* 1950;60:263-6.
  25. Kimberlin RH. Biochemical approaches to scrapie research. *Trends Biochem Sci* 1977;2:220-3.
  26. Kimberlin RH, Walker CA, Millson GC, et al. Disinfection studies with two strains of mouse passaged scrapie agent. *J Neurol Sci* 1983;59:355-69.
  27. Lax AJ, Millson GC, Manning EJ. Can scrapie titres be calculated accurately from incubation periods. *J Gen Virol* 1983;64:971-3.
  28. Manuelidis L. Decontamination of Creutzfeldt-Jakob disease and other transmissible agents. *J Neurovirol* 1997;3:62-5.
  29. Outram GW. The pathogenesis of scrapie in mice. In: Kimberlin RH, editor. *Slow Virus Diseases of Animals and Man*. Amsterdam: North Holland; 1976. p. 325-57.
  30. Pocchiari M. Unpublished data cited by Hourad F. Safety of medicinal products: summary. *Dev Biol Stand* 1993;80:207-8.
  31. Prusiner SB. Molecular biology of prion diseases. *Science* 1991;252:1515-22.
  32. Prusiner SB. Prion diseases and the BSE crisis. *Science* 1997;278:245-51.
  33. Prusiner SB, McKinlay MP, Bolton DC, et al. Prions: methods for assay, purification, and characterization. In: Maramorosch K, Koprowski H, editors. *Methods in Virology*. Vol. VIII. New York: Academic Press; 1984. p. 293-345.
  34. Prusiner SB, Groth D, Serban A, Stahl N, Gabizon R. Attempts to restore scrapie prion infectivity after exposure to protein denaturants. *Proc Natl Acad Sci USA* 1993;90:2793-7.
  35. Rohwer RG. Scrapie inactivation kinetics — an explanation for scrapie's apparent resistance to inactivation — a re-evaluation of estimates of its small size. In: Court LA, Cathala F, editors. *Virus nonConventionnels et Affections due System Nerveux Central*. Paris: Masson; 1983. p. 84-113.
  36. Rosenberg RN, White CL, Brown P, et al. Precautions in handling tissues, fluids, and other contaminated materials from patients with documented or suspected Creutzfeldt-Jakob disease. *Ann Neurol* 1986;19:75-7.
  37. Somerville RA, Carp RI. Altered scrapie infectivity estimates by titration and incubation period in the presence of detergents. *J Gen Virol* 1983;64:2045-50.
  38. Taguchi F, Tamai Y, Uchida K, et al. Proposal for a procedure for complete inactivation

- of the Creutzfeldt-Jakob disease agent. *Arch Virol* 1991;119:297-301.
39. Tateishi J, Tashima T, Kitamoto T. Inactivation of the Creutzfeldt-Jakob disease agent. *Ann Neurol* 1988;24:466.
40. Taylor DM. Decontamination of Creutzfeldt-Jakob disease agent. *Ann Neurol* 1986;20:749.
41. Taylor DM. Spongiform encephalopathies. *Neuropathol Appl Neurobiol* 1991;17:345-6.
42. Taylor DM. Resistance of the ME7 scrapie agent to peracetic acid. *Vet Microbiol* 1991;27:19-24.
43. Taylor DM. Creutzfeldt-Jakob disease. *Lancet* 1996;347:1333.
44. Taylor DM. Transmissible subacute spongiform encephalopathies: Practical aspects of agent inactivation. In: Court L, Dodet D, editors. *Transmissible Subacute Spongiform Encephalopathies: Prion Diseases: IIIrd International Symposium on Subacute Spongiform Encephalopathies: Prion Diseases*; 1996 Mar 18-20; Paris, France. p. 479-82.
45. Taylor DM, Fernie K. Exposure to autoclaving or sodium hydroxide extends the dose-response curve of the 263K strain of scrapie agent in hamsters. *J Gen Virol* 1996;77:811-3.
46. Taylor DM, McConnell I. Autoclaving does not decontaminate formol-fixed scrapie tissues. *Lancet* 1988;1:1463-4.
47. Taylor DM, Fraser H, McConnell I, et al. Decontamination studies with the agents of bovine spongiform encephalopathy and scrapie. *Arch Virol* 1994;139:313-26.
48. Taylor DM, Woodgate SL, Atkinson MJ. Inactivation of the bovine spongiform encephalopathy agent by rendering procedures. *Vet Record* 1995;137:605-10.
49. Taylor DM, Woodgate SL, Fleetwood AJ. Scrapie agent survives rendering procedures. Abstracts of the Jubilee Meeting of the Association of Veterinary Teachers and Research Workers, Scarborough, p. 33.
50. Taylor DM, Fernie K, McConnell I. Inactivation of the 22A strain of scrapie agent by autoclaving in sodium hydroxide. *Vet Microbiol* 1997;58:87-91.
51. Taylor DM, Woodgate SL, Fleetwood AJ, Cawthorne RJG. The effect of rendering procedures on scrapie agent. *Vet Record* 1997;141:643-9.
52. Wilesmith JW, Wells GAJ, Cranwell MP, Ryan JBM. Bovine spongiform encephalopathy: epidemiological studies. *Vet Record* 1988;123:638-44.



# Inactivation of Prions by Hyperbaric Rendering Procedures<sup>1</sup>

B.E.C. Schreuder, D.V.M.<sup>1</sup>, R. E. Geertsma, M.Sc.<sup>2</sup>, L.J.M. van Keulen, D.V.M.<sup>1</sup>, J.A.A.M. van Asten, Ing, B.Sc.<sup>3</sup>, P. Enthoven, M.Sc.<sup>4</sup>, R.C. Oberthür, Ph.D.<sup>5</sup>, A.A. de Koeijer, M.Sc.<sup>1</sup>, and A.D.M.E. Osterhaus, D.V.M., Ph.D.<sup>3</sup>

<sup>1</sup>*DLO-Institute for Animal Science and Health (ID-DLO), The Netherlands*

<sup>2</sup>*National Institute of Public Health and the Environment (RIVM), The Netherlands*

<sup>3</sup>*Formerly at RIVM, The Netherlands*

<sup>4</sup>*Cooperative Central Laboratory, The Netherlands*

<sup>5</sup>*Fleischmehlfabrik Brögbern, Germany*

The present study assesses the efficacy of the procedures in use at two rendering plants in the Netherlands. The experiments were performed on a laboratory-scale using procedures simulating the pressure-cooking part of the rendering procedures. Pools of BSE-infected brain stem material and scrapie-infected brain stem materials were used to spike rendering materials. These mixtures were subjected to various time-temperature combinations of hyperbaric heat treatment related to the Dutch rendering conditions in the early 1990s, as well as to the combination of 20 minutes at 133°C required by the E.U. Directive on rendering of 1996. With the 20-minute, 133°C procedure, there was a reduction of BSE infectivity of about 2.2 log in the first series, and in the second series more than 2.0 log. Data obtained with undiluted brain material indicated an inactivation, in this form, of about 3.0 log. With the same procedure, scrapie infectivity was reduced by more than 1.7 log in the first series and more than 2.2 log in the second series. Results with undiluted brain material indicated an inactivation in excess of 3.1 log. In all three cases with the scrapie material, no residual infectivity was detected. Especially in processes with lower time-temperature exposure, the BSE agent consistently appeared more resistant to heat inactivation procedures than the scrapie agent.



# Introduction

Bovine spongiform encephalopathy (BSE) has surfaced as a major veterinary problem in cattle over the last decade. Not only is animal health at stake, implications for public health must also be considered. The earlier recognition of the BSE agent as a possible cause of a new variant of Creutzfeldt-Jakob disease (vCJD) in humans [21] had already placed BSE in the spotlight, which was further accentuated by recent confirmatory data indicating that a link between this form of CJD and BSE does exist [2,8]. The resulting public concern about the zoonotic potential of the disease reaches far beyond the borders of the United Kingdom (U.K.), highlighting the need for the assurance of a 'safe food chain'.

Early in the BSE epizootic, it was concluded on the basis of epidemiological data that cows had contracted the disease via oral exposure to meat and bone meal (MBM) infected with a transmissible spongiform encephalopathy agent, possibly originating from scrapie-infected sheep [18,19,20]. In the U.K., rendering conditions since the late 1970s and early 1980s had been changed to conditions which apparently insufficiently inactivated the BSE agent [18]. It is now generally accepted that recycling BSE-infected material in cattle was the key factor in driving the epizootic.

The risks associated with the import of possible BSE-contaminated products or BSE-infected animals, and the possibility that BSE might emerge as a result of recycling of indigenous scrapie infectivity, prompted the evaluation of rendering procedures in the Netherlands.

The difficulty of inactivating the agents causing transmissible spongiform encephalopathies (TSEs) or prion diseases was shown, before BSE emerged, by a number of thermal inactivation studies with the agents causing scrapie or CJD [11,14]. For the inactivation of most scrapie strains, hyperbaric wet heating at hyperbaric pressures of 20 psi ( $\approx 2.4$  bar) at  $126^{\circ}\text{C}$  seemed to be effective. For the most thermoresistant scrapie strain, 22A, 4 minutes of heat exposure at 30 psi ( $\approx 3.1$  bar) at  $136^{\circ}\text{C}$  proved to be effective, when porous load autoclaving procedures were used. However, later studies proved to be less reassuring [15].

The resistance of TSE agents to dry heat exposure was even more notorious, especially after reports had emerged that scrapie agent even resisted ashing, at least in part [1]. So far, no experiment had mimicked actual rendering conditions, as the experiments were almost all performed with brain macerates in heated autoclaves. The first rendering experiments with the BSE agent were reported in 1995 [16], which were soon followed by similar rendering studies using scrapie-infected materials in the U.K. [17]. In these experiments, a range of rendering processes in use in the European Union (E.U.) were evaluated in pilot scale facsimiles, including hyperbaric ones.

Our studies are confined to variations within the hyperbaric process. Their aim was to assess the efficacy of the Dutch rendering process to inactivate the causative agents of BSE and scrapie. Since heat treatment at high temperature under hyperbaric conditions ('pressure cooking') is considered the most essential and critical part of the inactivation process, only this part of the rendering process was evaluated. The possible effect of other components of the rendering process was not considered.

In the early 1990s, this 'pressure cooking' was performed at one of the two Dutch rendering plants (plant A) as a batch process, whereas at the other plant (plant B) a continuous process was used. The Dutch Rendering Directive, in force at the time of inception of the study (1990/91), specified minimum holding times of 10 and 15 minutes for the continuous and batch processing plants, respectively, at temperatures above 130°C at hyperbaric conditions. These minimal requirements were in addition to specified longer holding times at lower temperatures.

Since 1996, both plants operate according to a batch processing system with a minimum holding time of 20 minutes at 133°C, thus complying with current E.U. directives.

In this paper we describe laboratory studies using BSE- or scrapie-agent-spiked rendering materials in different well-defined, hyperbaric inactivation cycles, which were based on the situation in the plants at the time of inception of the study. The purpose of the study was first to assess the efficacy of an essential part of the Dutch rendering process in eliminating BSE and scrapie agents from the animal food chain and second, to determine inactivation kinetics of the processes.

# Materials and Methods

## *Collection and Preparation of the Material Used for Spiking*

One of the limitations of previous British rendering experiments [16] was the low initial titre in the spiking material. Because brain stem material, especially in the case of BSE, would contain higher infectivity titres than a mixture of whole brain [7,13; Ray Bradley, personal communication, 1992], only brain stem material was used in our experiments. The following materials were collected and used for spiking:

- a. Brain stems from six histologically-confirmed BSE-affected cattle, originating from five different farms (made available by kind permission of Dr. Keith Meldrum, CVO, U.K.).
- b. Brain stems from 60 histologically-confirmed scrapie-affected sheep, collected from 38 different farms throughout the Netherlands. No more than five brain stems per farm were included. Materials from at least eight different breeds of sheep (including foreign breeds) or their crosses were involved.

Approximately half of each paramedially-cut brain stem was available for these experiments. Both BSE and scrapie brain materials were homogenized using a Sorvall Omni-mixer. The BSE material was homogenized without adding other material; the scrapie material was diluted to a 66.6% suspension in saline, to facilitate mixing. The scrapie material was first mixed in batches of five samples each, after which a final pool was prepared from the initial batches. The brain materials were divided in appropriate aliquots and stored at  $-20^{\circ}\text{C}$  until used.

## *Material Tested*

The infectious materials (spike materials) were mixed with raw material for dilution. The raw material, mainly abattoir waste material, was obtained from one of the rendering plants as crushed and heat treated ( $<95^{\circ}\text{C}$ ) material containing 70% water, 14% protein, 10% fat, and 6% ash, and was considered to have a typical composition for this stage in the process. This crushed material was further homogenized in a Sorvall Omni-mixer and finally mixed with the spike material to obtain a 10% w/w mixture of spike material in partially-rendered material.

Thirty-mL glass containers, 'universal bottles' with screw-caps, were then two-thirds filled with the spiked rendering material for exposure to various hyperbaric heat treatment cycles.

## *Equipment*

Heat treatment cycles were performed in an autoclave with internal monitoring conditions. For this purpose, a 25 L steam sterilizer was adapted to allow the temperature to be set adequately and the exposure time to be interrupted immediately after the required test period had elapsed.

To monitor and control the exposure conditions, a pressure-temperature measuring system was used, since, after proper removal of air, pressure is the more accurate way to control the temperature. This system complies with the requirements of EN 285 [5], i.e., it measures one pressure with an accuracy of 1 kPa and at least five temperatures with an accuracy better than 0.5°C. Prior to a test series the entire measuring system was calibrated against in-house standards.

Dummy vials were used to monitor the actual heat exposure. Dummy vials were identical to the sample vials but contained clean, nonspiked material, i.e., rendering material to which 10% noninfected brain material had been added. One of the temperature sensors was placed inside a dummy sample vial in the center at one third of the material level (from the bottom). This position had been demonstrated to be the most critical position within the material to be treated [J. van Asten, unpublished observations]. During the heat treatment cycles, the dummy vial was placed adjacent to the sample vials. Due to the relatively small volume of the vials and the saturated steam heat up cycle, the temperature differences within the vial and between vials were considered negligible. With 70% water, the moisture in the sample-materials is considered sufficient to create an internal liquid- or steam-saturated microenvironment within the vials.

The temperature in the dummy vial was monitored throughout the cycle. Exposure time started when the recorded temperature reached the planned test temperature. This temperature was maintained throughout the required time after which the sterilizer was vented and the contents allowed to cool down. Sample vials were stored at -20°C pending bio-assay.

### *Experimental Procedures*

All experiments, including the preparation of the samples, were carried out in duplicate, in two independent series of experiments (Round I and Round II), and with both BSE and scrapie brain stems as spike material. The following temperature-time cycles were tested in separate test runs:

- A. 3 minutes at 105°C (survival of infectivity expected)
- B. 3 minutes at 121°C (survival of infectivity expected)
- C. 15 minutes at 125°C (theoretical worst case scenario plant A in 1993<sup>2</sup>)
- D. 3 minutes at 134°C (theoretical worst case scenario plant B in 1993<sup>2</sup>)
- E. 20 minutes at 133°C (EC directive 90/667)
- P. 20 minutes at 133°C (EC directive 90/667), one series with undiluted brain stem material only.

Since it was considered important to maximize the initial titre, we included one test run with undiluted spike material only, at the temperature/time combination with the presumably highest efficiency (20 minutes, 133°C) (Process P, along with Round II).

### *Bioassay in Mice*

Single user license provided by AAMI. Further copying, networking, and distribution prohibited.

For the bioassay, parent stock for our mouse strains, RIII/FaDk-ro, C57BL and VM mice, was obtained from the Neuropathogenesis Unit (NPU), Edinburgh, of the Institute of Animal Health, by kind permission of Dr. Chris Bostock. The material used for spiking was titrated in 10-fold dilutions (six or seven steps) in groups of six to eight mice each:

- BSE brain stem material in RIII/FaDk-ro mice
- scrapie brain stem material in C57BL and VM mice

The heat-treated spiked material was also assayed undiluted and in 10- and 100-fold dilutions, in the same strains of mice, in groups of 15 to 16 mice each. In addition, in the lowest time-temperature combination (3 minutes, 105°C), one extra dilution step was included. Not all tests with scrapie material were done in C57BL and VM mice because of breeding difficulties with the VM strain and because of hypersensitivity to the antibiotic solution with the C57BL strain. We therefore had to resort temporarily to RIII for scrapie material as well.

Aliquots of the pooled brain stem material used for spiking were diluted in an antibiotic solution containing 5000 IU penicillin and 5000 µg streptomycin per mL, made in-house. Aliquots of the heat-treated material were also diluted, initially in the same solution, but after problems with one strain of mice (C57BL) this was discontinued and sterile saline was used thereafter. No bacteriological screening was performed and no problems related to possible bacteriological contamination were encountered.

Mice were inoculated by simultaneously administered injections of 0.02 mL intracerebrally (i.c.) and 0.5 mL intraperitoneally (i.p.), essentially as described by Taylor *et al.* [16]. The inoculum was prepared with an Ultra-Turrax T25 homogeniser. Homogeniser probes were decontaminated in between usages by porous-load autoclaving of two cycles of 30 minutes at 136°C each, with washing with detergent in between. Homogenates were centrifuged for 5 minutes at 500 G and the supernatants used for the bioassay.

Mice were observed and clinically monitored daily from the start of a possible incubation period up to 900 days. From all mice surviving the first 10 days, the brains were examined histologically, they were immersion-fixed in 10% formol-saline and histological sections prepared from five different coronal sections were stained with haematoxylin and eosin and examined microscopically for the presence of spongiform lesions. All brains were also examined by immunohistochemistry, consisting of PrP<sup>Sc</sup> staining with a peptide-based antibody, R505, directed against murine PrP<sup>Sc</sup>. Positive results were based on both these techniques in which the presence of PrP<sup>Sc</sup> was considered decisive.

### *Calculation of Infectivity Titre and Reduction*

The results of the animal experiments can be expressed as the infectivity of the samples per mL (or gram) of inoculum, in this case the number of ID<sub>50</sub> doses per gram. This was calculated with the Kärber method [9] and an alternative method which uses a generalized linear model (GLM). For the latter we assumed that an inoculum contains a number of equal BSE or scrapie particles which all have an equal probability of inducing infection. We therefore used the following dose-response model:

$$\text{response} = 1 - e^{-\text{dose} \cdot \text{titre}}$$

After having thus estimated the average infective dose, we converted this to an ID<sub>50</sub> titre to allow comparison with the Kärber method.

For the titre calculations we divided the number of positive mice by the number of mice surviving to the date of the earliest confirmed positive mouse in the dilution group. If no positive occurred in any one group, the data of the dilution group preceding this one was used. In the event mortality in the undiluted group approached, but did not fully reach, 100% and in which the next dilution step yielded a full 100% mortality, we considered the first result an artefact (probably the result of difficulties with inoculating undiluted material). Consequently, we assumed in such a case a 100% score for the undiluted group as well.

For calculating the reduction in titre caused by a certain process, we calculated the titre back to the initial 100% concentration of the spike. Values calculated with the Kärber method and those with the GLM used their own reference values. In the conclusions and discussion, we have used the Kärber-calculated values to be able to relate to other research data.

The reduction of the infectivity titre caused by a process is an indication for the efficacy of an inactivation process which is determined by the temperature and the holding time. The inactivation mechanism in the rendering process is, just like that in steam sterilization processes, the effect of moist heat on microorganisms and/or other transmissible agents. The inactivation kinetics of microorganisms for steam sterilization can be described as a first order reaction. For this, an equation is applicable in which the decimation time  $D$  (the time needed for 1 log reduction at a certain temperature) and the resistance coefficient  $Z$  (the effect of a temperature change on the decimation time) are unknown variables. If the same equation is valid for the inactivation kinetics of prions, it should be possible to determine these unknown variables using the results of the series of experiments that have been performed and provided that several 'sub-lethal' processes were performed.

# Results

All experiments were carried out in duplicate (Round I and Round II). The infectivity titres in the pooled brain stem materials used for spiking are presented in Table 1.

**Table 1. Infectivity Titres in Pooled Brain Stem Material (Spike)**

Round of Experiment	Brain Stem Material and Strain of Mice		Titre in Log ID <sub>50</sub> /g	
			Kärber Method*	GLM Titre (se)**
Round I	Scrapie	VM	3.1	2.8 (0.3)
	Scrapie	C57BL	3.5	3.5 (0.3)
	BSE	RIII	3.8	3.7 (0.4)
Round II	Scrapie	VM	2.4	2.4 (0.2)
	Scrapie	C57BL	3.4	3.4 (0.4)
	BSE	RIII	3.6	3.4 (0.2)

\* calculated by the method of Kärber (1931).

\*\* calculated using a generalized linear model (GLM) (se = standard error).

Note: Both methods were corrected for the initial dilution step (66.6%) in the case of scrapie.

The resulting temperature profiles of the above described five different time-temperature exposures A through E, as measured at the internal monitoring points in the dummy vials, are given in Figure 1. There was a penetration interval of about 5 minutes after which the heating-up period started, in general requiring between 10 and 15 minutes, until planned temperatures were reached (Figure 1). Only one profile for each cycle is presented, but the temperature profiles of the two rounds of experiments were virtually congruent.

The impact of the various heat exposure cycles on the infectivity titres was assayed in mice, results of which are expressed in log ID<sub>50</sub>/g of undiluted spike material (Tables 2 and 3; Figure 2).

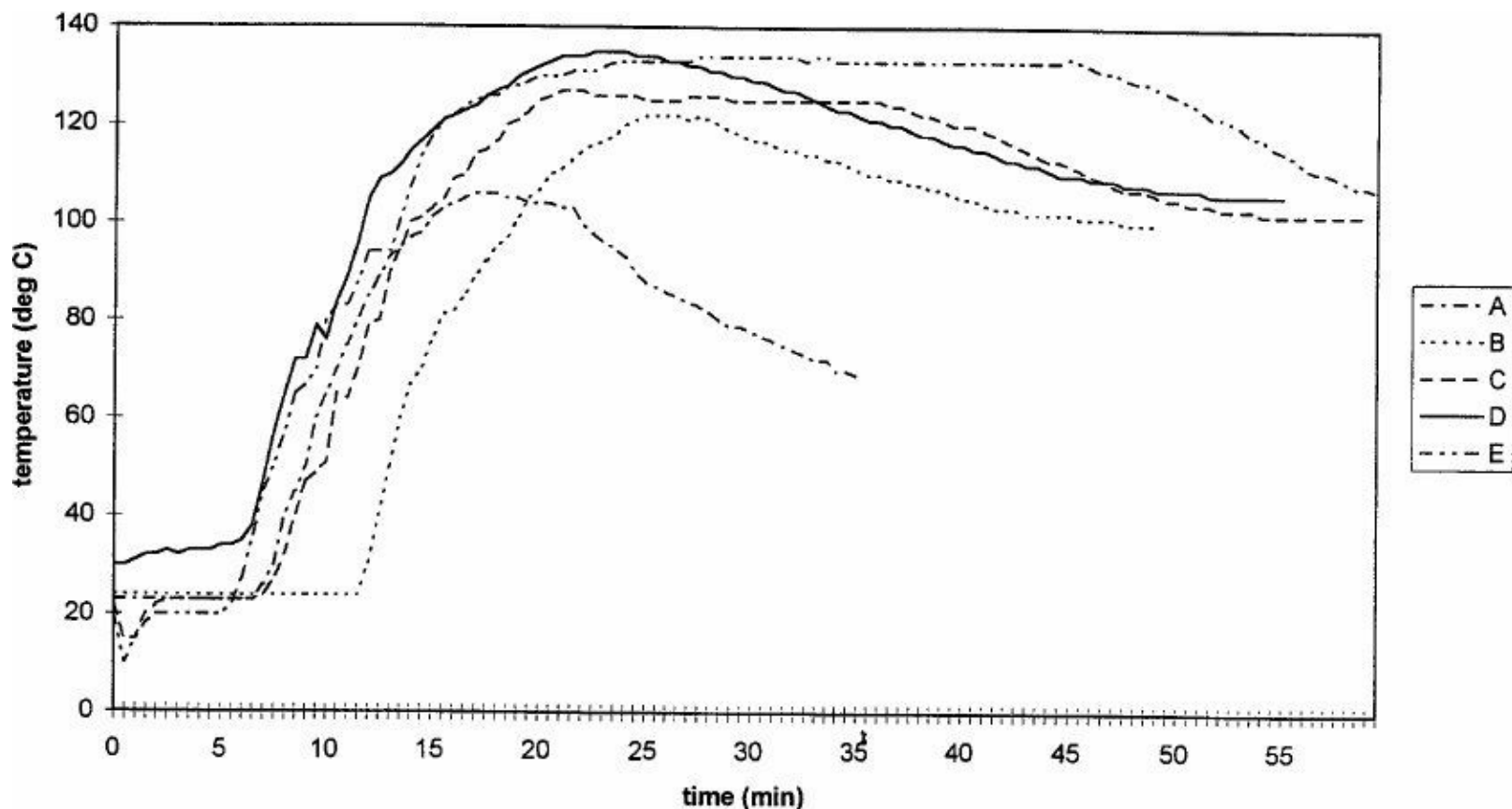

Figure 1. Temperature profiles of processes A through E.

Table 2. Reduction of Infectivity Titres in Round I

Spiking Agent	Process Code	Process Time/Temp.	Strain of Mice used	Titre after Heat Treatment (Log ID <sub>50</sub> /g)		Reduction Factor* (Log 10)	
				Kärber	GLM (+ se)	Kärber	GLM
Scrapie	A	3 min / 105°	RIII	3.9	3.9 (0.2)	-	-
	B	3 min / 121°	RIII	2.9	2.2 (0.2)	1.0	1.7
	C	15 min / 125°	RIII	2.0	1.2 (0.4)	1.9	2.7
	D	3 min / 134°	C57BL	<1.8	<1.1	>1.7*	>2.4*
	D	3 min / 134°	RIII	<1.8	<1.1	>2.1	>2.8
	D	3 min / 134°	C57BL	<1.8	<1.1	>1.7*	>2.4*
BSE	E	20 min / 133°	VM	<1.8	<1.1	>1.3*	>1.7*
	E	20 min / 133°	C57BL	<1.8	<1.1	>1.7*	>2.4*
	A	3 min / 105°	RIII	4.0	4.0 (0.2)	-	-
	B	3 min / 121°	RIII	3.8	3.8 (0.2)	0.2	0.2
	C	15 min / 125°	RIII	2.4	2.7 (0.3)	1.6	1.3
	D	3 min / 134°	RIII	n.c.	1.9 (0.5)	n.c.	2.1
	E	20 min / 133°	RIII	≈1.8	1.7 (0.2)	≈2.2	2.3

Note: All titres were calculated by the method of Kärber and using a generalized linear model (GLM) (se = standard error) and calculated back to 100% brain material.

\* Because we considered material tested in the same constitution (as 10% spike in rendering material) and in the same round of experiments to be a closer and more comparable reference material than the original spike, we used the titre in process A (lowest heat exposure) as the reference titre. Only where a different mouse-line was used, we refer to the original spike titre (indicated with \*).

n.c. not calculated: calculation not valid due to limited number of mice.

Table 3. Reduction of Infectivity Titres in Round II



Spiking Agent	Process Code	Process Time/Temp.	Strain of Mice used	Titre after Heat Treatment (Log ID <sub>50</sub> /g)		Reduction Factor* (Log 10)	
				Kärber	GLM (+ se)	Kärber	GLM
Scrapie	A	3 min / 105°	C57BL	4.0	4.0 (0.2)	-	-
	B	3 min / 121°	C57BL	2.8	2.3 (0.3)	1.2	1.7
	C	15 min / 125°	C57BL	2.2	1.8 (0.2)	1.8	2.2
	D	3 min / 134°	C57BL	n.c.	1.4 (0.5)	n.c.	2.6
	E	20 min / 133°	C67BL	<1.8	<1.3 (0.3)	>2.2	>2.7
	P***	20 min / 133°	RIII	<0.8	<0.3 (0.2)	>3.1**	>3.7
BSE	A	3 min / 105°	RIII	3.8	3.8 (0.2)	-	-
	B	3 min / 121°	RIII	3.7	2.8 (0.1)	0.1	1.0
	C	15 min / 125°	RIII	2.8	2.7 (0.2)	1.0	1.1
	D	3 min / 134°	RIII	≈1.6	1.3 (0.3)	≈2.2	2.5
	E	20 min / 133°	RIII	<1.8	<1.3 (0.3)	>2.0	>2.5
	P***	20 min / 133°	RIII	≤0.8	<0.3 (0.3)	≥3.0	>3.5

- \* The titre from process A (lowest heat exposure) was used as the reference titre. Reduction was calculated using the same mathematical method each time.
- \*\* The titre in process A of Round I was used as the reference value, because this was the only one available for scrapie in RIII mice.
- \*\*\* Code P represents undiluted brain material.
- n.c. not calculated: calculation not valid due to limited number of mice.

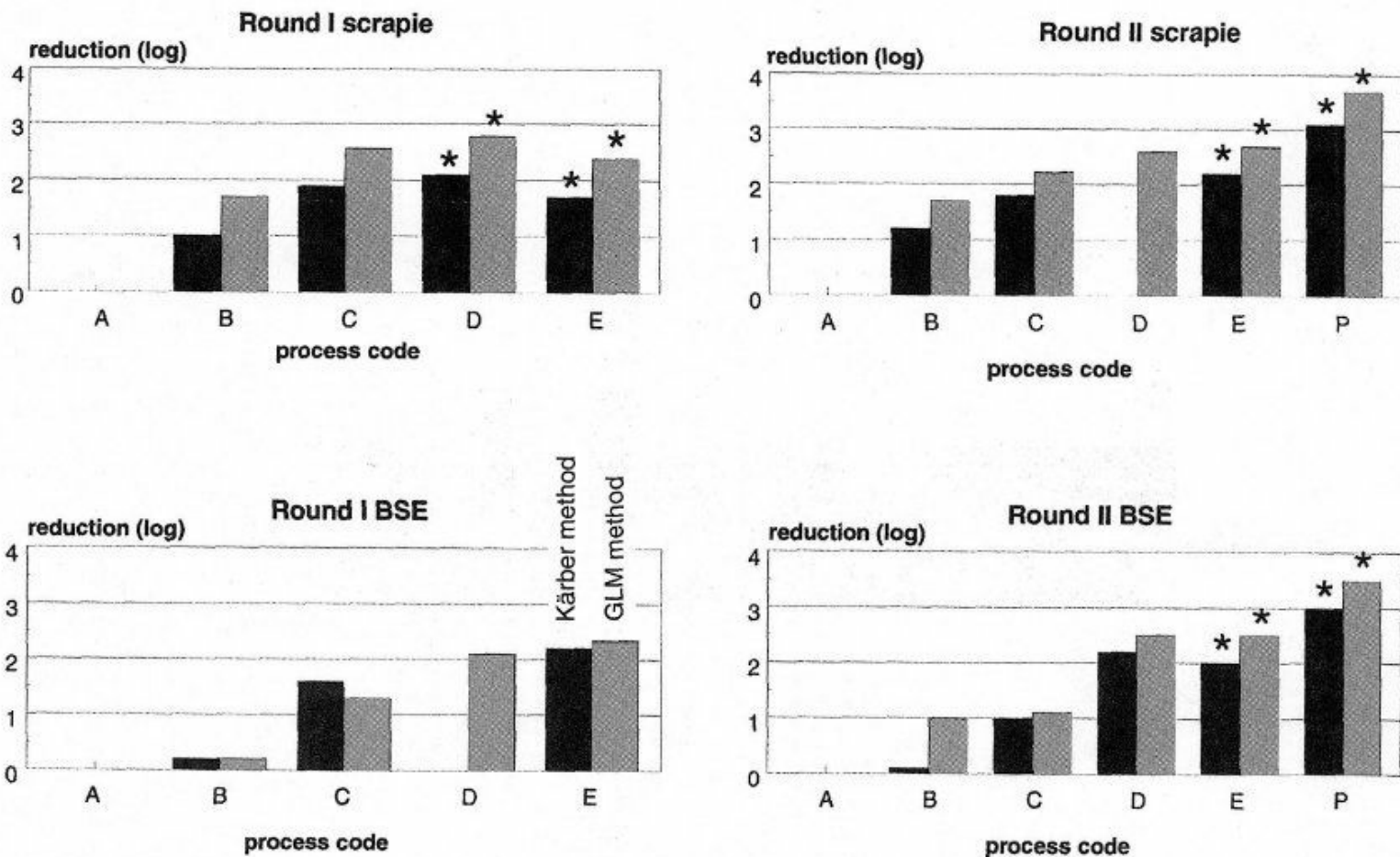

**Figure 2.** Impact of various heat exposure cycles on infectivity titres.

\* Reduction exceeded measuring window of study.

Results demonstrate for the 20-minute, 133°C process (code E) a reduction of infectivity for scrapie greater than 1.7 log (Round I) and greater than 2.2 log (Round II). The results

with undiluted brain material (code P in Round II) indicate that the inactivation is, in this form, also in excess of 3.1 log (all calculated with the Kärber method).

For BSE the results for this process demonstrate a reduction of infectivity in the order of 2.2 log (calculated by both mathematical methods) in Round I, and in excess of 2 log in Round II. The results with undiluted brain material (code P) indicate that, in this form, inactivation is in the range of 3 log (Kärber method).

Titre reductions for BSE and scrapie infectivity by processes that were considered the theoretical worst case scenarios for the two plants in the Netherlands in the early 1990s, proved to be 0.5 to 1.5 logs smaller.

# Discussion

The experiments described can be seen as complementary to the pilot-scale rendering experiments described by Taylor *et al.* [16,17]. These authors used a broad range of time-temperature protocols and simulations of different rendering processes, whereas we focused on hyperbaric procedures with regard to inactivation of BSE and scrapie agents.

Although initially planned to evaluate the Dutch rendering conditions (which are largely comparable with the German and the Belgian processes), results of the present study may have a wider bearing since implementation of the E.U. Directive on rendering in 1996 [3]. This Directive stipulates that mammalian MBM may only be fed to mammals if it has been produced by a hyperbaric process of at least 20 minutes at 133°C at 3 bar.

Our experiments cover only part of the total rendering process, but we nevertheless think that these experiments provide an indication of what to expect from the rendering process as presently recommended by E.U. directives. The laboratory scale of our experiments, however, calls for an additional phase of translating the findings into commercial scale processes in which additional variables such as dilution of infective material, particle size, heat penetration time, stirred vessels, etc. should be considered. To address these issues, studies that cover the whole length of the rendering process should probably be carried out. The pilot scale experiments carried out in the U.K. [16,17] provide part of the answer, but for hyperbaric processes comparable to the 3 bar, 20-minute process, they only indicate that inactivation will be at least 80-fold in the case of BSE.

Our experiments also provide essential inputs for modeling studies calculating the risk entailed by the inclusion of the final product, MBM, in feed for ruminants, be it purposely as happened in the past, or accidentally as the result of cross-contamination within the system.

One of the aims of our study was to be able to quantitatively describe the inactivation kinetics of the respective agents during hyperbaric heat-treatment processes. This would imply that for any desired reduction of infectivity, the required treatment could be calculated (without having to go through lengthy animal experiments). Unfortunately, this was not possible with the data obtained from the present study. This is primarily because for a reliable calculation of the inactivation kinetics, a dose-response curve is needed which is derived from a range of experimental results in the measuring window of the assay. Those results that show a zero reduction and those below the detection level of  $10^{1.8}$  ID<sub>50</sub>/g cannot be used for the actual calculation, but only as controls of the outcome. In our study, the measuring window was about 2 log (3 log in the undiluted series) and unfortunately there were not enough results inside this window to allow a reliable calculation. Therefore, the question of whether inactivation of prions follows first order inactivation kinetics with characteristic D- and z-values cannot be answered as of yet based on the data generated in this study.

We hope that this may be the case when the results of three additional heat-treatment cycles become available. These were added when the results from the initial spike titrations became available to allow for more accurate determination of the processes studied:

G. 20 minutes at 100°C (atmospheric)

H. 10 minutes at 130°C

The bioassays of these three processes are presently still in progress and this interim report therefore deals with the first group of time-temperature combinations only.

### *Infectivity Titres*

One of the basic limitations of this type of experiment is not the scale in which they are carried out, but the injection material used. We intentionally opted for the 'natural' hosts as providers of source material, and for mixing the spike material with rendering material, as this would reduce a number of uncertainties in translating our findings. We could have opted to work with strains of TSE agents that had already been passaged in the same experimental animals as used in our bioassay, in which case our initial titre would have been much higher and thus the measuring window larger. Thermoresistance could, however, have changed during this process of adaptation, which is why we decided to work directly with bovine BSE and ovine scrapie-infected materials.

Primo-inoculations of scrapie and BSE in mice using 0.02 or 0.03 mL i.c inoculations only, generally show titres approximately only 1.0 log higher than our spiking material [6,7]. This difference can be explained by differences in route and inoculum size: if we had used only 0.02 mL i.c. and 0.1 mL i.p., which is presently known to be as efficient as 0.02 mL i.c. combined with 0.5 mL i.p. [15], our titres per mL would have been about 0.6 log higher.

Compared to the only other rendering studies performed thus far [16,17], the titres of our spike material were approximately 0.5 log lower in the case of scrapie when measured in C57BL mice, whereas the level of infectivity for BSE measured in the same mice-strain RIII, was about 1.0 log higher in our material. Our BSE-infectivity titre was also in the same order of magnitude as the titration results of other inactivation studies have indicated [15].

### *Problems with Bioassay, Different Mouse Strains Used*

When we began with the inoculations of the heat-treated materials, the C57BL mice used for the scrapie materials started to give problems immediately upon i.c. injection. By inoculating the various components of the inoculum separately, we concluded that a hypersensitivity connected with one of the components of the antibiotic solution used for diluting the inoculum was the cause of the problems encountered with the C57BL mice. This problem later occurred in the NPU, Edinburgh [personal communication, David Taylor, 1997].

Because of the problems encountered with the C57BL mice, we were forced to change to RIII mice for the heat-treated scrapie materials in Round I. Unfortunately we did not have a reference titre of the original spike material in this line of mice (RIII). As an alternative we used the titre in the lowest heat treatment cycle (process A) in RIII as the reference titre. We considered this justified as we were dealing with material prepared in one batch (per round of experiments), which may be considered more comparable than the undiluted spike material. In addition, we did not anticipate any detectable inactivating effect by process A.

For reasons of homology, we acted similarly in calculating the results of BSE materials in Round I and for both scrapie and BSE materials in Round II.

### *On the Results*

We found no titre reduction at the lowest heat exposure process, code A, i.e., 3 minutes at 105°C, whereas process B (3 minutes at 121°C) caused about 1.0 log reduction in titre for scrapie, but not for BSE infectivity. Process C, 15 minutes at 125°C, gave a reduction in titre of almost 2.0 log for scrapie, whereas for BSE the reduction was on an average just over one log. Noteworthy is the increased efficiency of process D compared to process C, especially for BSE infectivity: 3 minutes at 134°C is thus more efficient than 15 minutes at 125°C.

For the present E.U.-endorsed process (code E, process of 20 minutes, 133°C at 3 bar), our results showed a reduction of infectivity for scrapie in excess of about 2.0 logs, taking the average of both rounds. If we were allowed to interpret the results with undiluted scrapie brain material, the inactivation appears to be in excess of 3.1 log.

For BSE our results demonstrated for this process in Round I a reduction of infectivity in the order of 2.2 log, in Round II in excess of 2.0 log, whereas the results with undiluted brain material (code P) indicated that the inactivation is most likely to be in the range of 3 log. This is a refinement of the results of the pilot scale experiments performed in the U.K. [16,17] indicating for hyperbaric processes an inactivation of at least 80-fold for BSE.

A likely explanation for the rather disappointing low efficacy of process E, 20 minutes, 133°C at 3 bar (at least in Round I), could be that within our mixed material, prions are partitioned partially in the fat component, thereby being protected from the wet-heat exposure. The efficacy of heat in inactivating TSE agents in a lipid environment differs from that in conditions with saturated steam. Stirring might improve the efficacy of inactivation for such a process which could be the topic of a follow-up study. Another explanation could be protective aggregation, where quantities of the agent survive due to the influence of the molecular microenvironment [12].

Comparative BSE agent titrations in mice and cattle have now indicated that there is a considerable difference in sensitivity between mice and cattle: cattle can be as much as 1000-fold more susceptible to i.c. exposure with the BSE agent than mice [personal communication, Ray Bradley, 1997; G.A.H. Wells and S.A.C. Hawkins, unpublished data]. This implies that even with process E, the residual level of BSE infectivity could be considerable for cattle, albeit the above-mentioned experiments involved i.c. inoculations and not oral exposure. The efficacy of exposure by the oral route is generally assumed to be about 10<sup>5</sup>-fold less than exposure by the i.c. route [10]. These factors could, together with the results of inactivation studies, form the basis of risk assessment studies or experimental transmission studies using cattle as target animals.

Collectively, our results indicate that with the E.U. recommended process E, 20 minutes, 133°C at 3 bar, a 100- to 1000-fold reduction of BSE infectivity is obtained. These results do not guarantee absolute absence of any risk for ruminants in cases where material with high levels of BSE-infectivity enters the rendering process. This is presently blocked by the

ban on rendering specified risk materials from ruminants [4]. Follow-up studies covering the total length of the rendering process together with risk assessment studies could provide an answer on whether residual infectivity in case of BSE still constitutes a tangible risk for maintaining or creating an epidemic.

# Acknowledgments

The experiments were a joint study by three Dutch Institutes or Laboratories. Representatives of these participated in a specially established Working Group and provided guidance throughout the course of the study. Advice from British scientists, especially David Taylor, was obtained on a regular basis. Useful suggestions were also received from Ray Bradley. The critical but constructive comments of Prof. Jaap van Bekkum, throughout the course of the experiments, were equally appreciated.

The authors further wish to thank Adrie de Bruijn for carrying out the heat-treatment procedures; Arjan van Drongelen for assistance in the interpretation of temperature profiles; Henk Sloetjes for assistance in the start of the mice unit; Peter van Rossum, Bernard Voorburg, and other co-workers of ID-DLO's Department for Experimental Animal Services for carrying out the mice inoculations and care for and almost endless monitoring of the animals; Jeanet Rutgers without whom the administration of the more than 1000 involved mice would have been a mess; Ad Korevaar and Ad Bartelse for carrying out necropsies; and finally Joyce Vromans for meticulously preparing and staining all histological sections.

Initially, the study was financially supported fully by the Ministry of Agriculture, Nature Management and Fisheries (DWT), whereas extensions of the research have been made possible by the former in conjunction with the Dutch Rendering Association and the Ministry of Welfare, Health and Cultural Affairs.

# References

1. Brown P, Liberski PP, Wolff A, Gajdusek DC. Resistance of scrapie infectivity to steam autoclaving after formaldehyde fixation and limited survival after ashing at 360°C: Practical and theoretical implications. *J Infect Dis* 1990;161:467-72.
2. Bruce ME, Will RG, Ironside JW, et al. Transmissions to mice indicate that "new variant" CJD is caused by the BSE agent. *Nature* 1997;389:498-501.
3. Commission Decision. Official Journal of the European Communities. 1996; L 184, 43.
4. Commission Decision (97/534EC). 1997.
5. EN 285. Sterilization — Steam Sterilizers — Large Sterilizers; 1997.
6. Fraser H, Bruce ME, Chree A, McConnell I, Wells GAH. Transmission of bovine spongiform encephalopathy and scrapie to mice. *J Gen Virol* 1992;73:1891-7.
7. Hadlow WJ, Race RE, Kennedy RC, Eklund CM. In: Prusiner SB, Hadlow WJ, editors. *Slow Transmissible Diseases of the Central Nervous System*, Vol. 2. London: Academic Press; 1997. p. 3.
8. Hill AF, Desbruslais M, Joiner S, et al. The same prion strain causes variant-CJD and BSE. *Nature* 1997;389:448-50.
9. Kärber G. Beitrag zur kollektiven Behandlung pharmakologische Reihen Versuche. *Arch Exp Pathol Pharmacol* 1931;162:480-3.
10. Kimberlin RH. A scientific evaluation of research into BSE. In: *Transmissible Spongiform Encephalopathies: Proceedings of a Consultation on BSE with the Scientific Veterinary Committee of the European Communities*; 1993 Sept. 14-15; Brussels, Belgium. (F 11.3 JC/0003) 1994; p. 455-77.
11. Kimberlin RH, Walker CA, Millson GC, et al. Disinfection studies with two strains of mouse-passaged scrapie agent. *J Neurol Sci* 1983;59:355-69.
12. Rohwer RG. Scrapie infectious particle is virus-like in size and susceptibility to inactivation. *Nature* 1984;308:658-62.
13. Scott AC, Wells GAH, Stack MJ, White H, Dawson M. Bovine spongiform encephalopathy: detection and quantitation of fibrils, fibril protein (PrP) and vacuolation in brain. *Vet Microbiol* 1990;23:295-304.
14. Taylor DM. Decontamination of scrapie-like agents. In: Bradley R, Savey M, Marchant BA, editors. *Sub-Acute Spongiform Encephalopathies. Proceedings of a Seminar in CEC Agricultural Research Programme*, Brussels, 12-14 November 1990. Dordrecht, The Netherlands: Kluwer Academic Publishers; 1991. p. 153-9.
15. Taylor DM, Fraser H, McConnell I, et al. Decontamination studies with the agents of bovine spongiform encephalopathy and scrapie. *Arch Virol* 1994;139:313-26.
16. Taylor DM, Woodgate SL, Atkinson MJ. Inactivation of bovine spongiform encephalopathy agent by rendering procedures. *Vet Rec* 1995;137:605-10.
17. Taylor DM, Woodgate SL, Fleetwood AJ, Cawthorne RJG. The effect of rendering procedures on scrapie agent. *Vet Rec* 1997;141:643-9.
18. Wilesmith JW, Ryan JBM, Atkinson MJ. Bovine spongiform encephalopathy: epidemiological studies on the origin. *Vet Rec* 1991;128:199-203.
19. Wilesmith JW, Ryan JBM, Hueston WD. Bovine spongiform encephalopathy: case-



control studies of calf feeding practices and meat and bone meal inclusion in proprietary concentrates. *Res Vet Sci* 1992;52:325-31.

20. Wilesmith JW, Wells GAH, Cranwell MP, Ryan JBM. Bovine spongiform encephalopathy: epidemiological studies. *Vet Rec* 1988;123:638-44.

21. Will RG, Ironside JW, Zeidler M, et al. A new variant of Creutzfeldt- Jakob disease in the UK. *Lancet* 1996;374:921-5.

---

1. Adapted with permission from a previously published article: Schreuder BEC, Geertsma RE, van Keulen LJM, et al. Studies on the efficacy of hyperbaric rendering procedures in inactivating bovine spongiform encephalopathy (BSE) and scrapie agents. *The Veterinary Record* 1998;142:474-80.

2. NOTE: These were considered the theoretical worst case scenarios for any material at the start of the experiments (around 1993) for both plants in the Netherlands. It should be stressed that presently both plants operate as batch processing plants and comply with current E.U. directives.



# Discussion

## The Biology and Inactivation of Prions

**Question for Dr. Will, University of Edinburgh, U.K.:** In your opinion, what is the probability of CJD in the United Kingdom over the next 1 to 2 years, 2 to 5 years, or other periods of time?

**Answer by Dr. Will:** That's a critically important question in the United Kingdom and various opinions have been expressed. About 6 months to 1 year ago, it was suggested that there may be an epidemic of biblical proportions. More recently, senior scientists have suggested there may be no more than 1500 cases. I think the true position is that we just don't know at the moment what is likely to happen. The problem is that we presently don't know what the incubation period for the disease is, which is the critical determinate of the future numbers of cases.

**Question for Dr. Prusiner, University of California, San Francisco, U.S.A.:** What is believed to be the normal function of PrP?

**Answer by Dr. Prusiner:** At the moment, we don't know what the normal function of PrP is, although there have been several interesting studies to help answer this question. It's very hard to do when the protein doesn't show up in the data base and someone has a purified PrP<sup>C</sup> at the end of a long purification protocol based on some biological activity. Some interesting studies using synthetic peptides for the octarepeats began several years ago and showed that these bind with copper. More recently it has been shown that the superoxide dismutase enzyme, which is very sensitive to reduced copper levels, is lower in the brains of null mice. More recent studies have found that membrane fractions extracted from the brains of null mice have 5% of the copper levels seen in normal mice. I think this is an extremely interesting and provocative result. It hasn't been repeated as far as I know, although our research group and possibly others are working on it. We found that, with recombinant PrP, the molecule binds two copper atoms per molecule and the binding occurs in the octarepeat region. Whether PrP is an important copper-binding protein or merely plays a role in copper metabolism is unclear. I should point out that in early studies by John Pattison and later by Richard Kimberlin, copper-chelating agents were used to mimic the pathology of scrapie. Chelating copper led to spongiform degeneration in animals which morphologically resembled, in some aspects, scrapie in mice.

**Question for Dr. Taylor, BBSRC/MRC Neuropathogenesis Unit, U.K.:** Have you tried to evaluate combined cleaning, such as ultrasonic baths, and then subsequent sterilization?

**Dr. Taylor:** The short answer is no, we haven't done those experiments although there is an experiment in progress. With our protocol, we are sampling immediately after

preparation of the brain suspension, again after one round of autoclaving, again after normal washing, and finally after autoclaving, washing, and then autoclaving again.

**Question for Dr. Taylor:** Can you make a specific recommendation for hospital sterilization of surgical instruments that have been used on a CJD patient?

**Answer by Dr. Taylor:** The recommendation in the United Kingdom is that instruments used in either ophthalmic or neurosurgery on suspect or known cases of CJD, or on individuals regarded as being at high risk for the disease because they belong to certain families or have received growth hormone, be discarded with no attempt to recycle. At present, it is permissible to use or recycle surgical instruments if they have been used in non-neurosurgical procedures on such patients. There is, however, some anxiety about the use of these instruments because, at the moment, we know absolutely nothing about the pathogenesis of nvCJD. For example, we don't know if there are high levels of infectivity in various tissues. Dr. Will has told us they detected PrP<sup>C</sup> in spleens in these cases where they hadn't previously. So, reuse of instruments from non-neurosurgical procedures performed in high risk or known/suspect CJD patients may be risky.

**Comment by Dr. Brown, National Institutes of Health, U.S.A.:** Certainly the best answer is to discard all instruments used in such individuals. Developing countries, among others, however, can't afford to throw surgical instruments away. What do you do, for example, with a fiberoptic gastroscope? You certainly don't use that once and throw it away.

Another possibility is that, among university or major hospitals, establish a set of instruments which are dedicated to specific patients or operations to avoid the possibility that any instruments used on a patient suspected of having CJD is used on any other patient. This would be one alternative to discarding every instrument that is used. Yet another possible alternative is tandem decontamination, perhaps starting with the use of a strong detergent, followed by sodium hydroxide or autoclaving at 134°C for at least 30 minutes, or the reverse process of autoclaving followed by sodium hydroxide or bleach.

Situations exist, though, where an instrument can't be submerged in bleach or sodium hydroxide or put in an autoclave yet it cannot be thrown away. In this situation I would suggest that the instrument be swabbed with one of these chemicals, whichever one seems appropriate, and allowed to rest for 30 to 60 minutes. That would certainly be much better than nothing. So, we are faced with compromises. The ideal is never to use the instruments again. Less than ideal is to devote a set of instruments to high-risk situations. And, one step further back would be to expose them to recommended decontamination procedures. The final step back would be to swab the instrument and hope for the best.

**Comment by Dr. Lederberg, The Rockefeller University, U.S.A.:** I might suggest that the notion of informed consent on the part of the patient be introduced into this equation. There is a very limited amount of concrete information that can be given to the patient, but I think the individual must be considered in reaching these kinds of decisions.

**Question for Dr. Will:** While there appears to be a correlation between BSE and CJD in the United Kingdom, does the incidence rate of CJD in countries that import beef from the United Kingdom correlate with the predicted incidence rate?

**Answer by Dr. Will:** I think that as far as nvCJD is concerned, any exposure of the human population is likely to have been very much higher in the United Kingdom than in any other country, including those which imported food products. I think also that any exposure would have started earlier in the United Kingdom. There has been only one case of nvCJD so far outside the United Kingdom. It's difficult to know what will happen in the future. The surveillance program within Europe should be continued to determine whether cases do occur in other countries, although it is my expectation that the number of cases of nvCJD will be much lower in other countries and would probably occur at a later date. Where classical CJD is concerned, there is really no good evidence that it is a zoonosis. If you look at the analysis of potential exposure of the human population to cattle or sheep in relation to the incidence of CJD in various countries around the world, there is no correlation at all. Therefore, as far as classical CJD is concerned, there is no good evidence that it is a food-borne disease.

**Question for Dr. Brown:** Would you comment on the B cell knockout experiments of Aguzzi related to the mechanism of infection?

**Answer by Dr. Brown:** Aguzzi has shown that, in a panel of immunogenetically immunodeficient strains of mice, the mature B cell appears to be critical for the scrapie agent to invade the brain and cause disease. He has recently told me that additional experiments have shown that both the B cells and T cells contain infectivity, which I think is no surprise. His group is now looking at the possibility that the B cell influence is exercised within the spleen rather than as a circulating agent. I think this is an expected possibility that if the B cell might function, for example, as a transporter of the infectious agent to a nerve ending in the spleen. An established pathway by which neuroinvasion can occur is to first go through the intestinal wall, from there into the spleen, from the spleen through the parasympathetic ganglia, and finally into the spinal cord and brain. It may now be that Aguzzi is honing in on the precise cell type that is involved in this transfer.

**Question for Dr. Brown:** Could you comment further on the correlation of CJD with the quantity or type of blood and blood products transfusion?

**Answer by Dr. Brown:** One of the things that I've recently learned is that whole blood transfusions are becoming increasingly rare. What is being used instead are blood components or substitutes. The experiments we performed are removed from the human situation in that they were conducted in rodents and, so far, the assays have been intercerebral. My guess, however, is that what we've observed in rodents may be an indication of what might be seen in the blood of a CJD patient. If this is true, then a concern is raised about the possibility of transmitting the disease from blood products. These include plasma, products made from white blood cells which currently include at least human interferon preparations, and possibly products made from the first two Cohn

fractions, including antihemophilic factor and immune globulin. In our model using an intercerebral assay, the cryoprecipitate is infectious. Experiments currently underway which will test the infectivity of the final product itself, including antihemophilic factor Factor 8, and I suspect that it will turn out not to be infectious despite the fact that the Cohn fraction from which it was produced contains a low level of infectivity. The reason for my supposition is that these products go through at least one, and sometimes two, chromatographic column steps which we know nonspecifically adsorb infectivities. My guess, therefore, is that even with low level infectivity in the Cohn fractions, the final product will turn out to be noninfectious. I think the same thing will be true of products made from plasma.

**Question for Dr. Schreuder, DLO - Institute for Animal Science and Health, The Netherlands:** What future improvements do you see in the rendering process?

**Answer by Dr. Schreuder:** We see the current recommended procedure within the European Community as an improvement over the previous method. The pressurized hyperbaric system also will represent an improvement when it's implemented. I don't see much further improvement in rendering per se. I would like to make a comment that via the rendering itself you can take additional precautions. Presently, you can remove all the so-called specified risk materials. Removing these from the rendering materials is a large improvement, and reduces the risk of recycling infectivity enormously.

**Comment by Dr. Taylor:** There is serious interest in developing more effective methods of rendering that maintain the nutritional quality of the end product. For example, there is interest in Canada in a very high pressure system and interest in Europe in combining alkaline conditions with rendering.

**Comment by Dr. Brown:** I would like to comment on why I think we haven't seen BSE in the United States. The rendering processes used in the United States have been the same as the rendering processes used in Great Britain. We have scrapie; they have scrapie. But the real question is why has BSE not emerged in the U.S.? It may be because the rendering process, even in its imperfect earlier forms, did in fact inactivate scrapie to a certain extent. If you can take one log of infectivity out of a preparation, you've taken 90% of the infectivity out. If you remove two logs, you've eliminated 99% of the infectivity. I think the reason BSE is not seen in the U.S. is that we have less scrapie, although it's very difficult to get the exact figures. For one thing there are fewer scrapie-infected sheep in this country. Secondly, the proportion of sheep material that is used at the start of the rendering process is considerably lower in the U.S. compared to Great Britain. Most of the rendered source material in this country is beef. Taken in combination, these two factors likely reduce the amount of scrapie that goes into the mix before rendering begins. I don't think the U.S. Government has made any recommendations or given any guidance to the rendering industry to change their rendering procedures. What they have done, which will probably be fully effective, is to institute a total mammal-to-ruminant feeding ban. That is, no mammalian tissue can now be a part of the nutrition of ruminants.

Single user license provided by AAMI. Further copying, networking, and distribution prohibited.

**Comment by Dr. Lederberg:** I feel obliged to restate my very speculative remarks that,

if the transition from the normal PrP protein to PrP<sup>Sc</sup> is a conformational change, then we have to be vigilant for processes which possibly induce this change in the processing of animal products and which might be used later on. It should be incumbent that there be, in the background of all process studies, very sensitive tests for the conversion of normal PrP into PrP<sup>Sc</sup> as a very consequence of the procedures that are used for decontamination and other processing methods. I realize some efforts have been made to look for this phenomenon. While they have not been successful, I think one has to worry about this precaution.

**Comment by Dr. Prusiner:** I think that the tests are very imperfect. One of the problems is that even where mice are used that are eventually sensitive, such as RIII mice to BSE, one is better off having a transgenic animal with a shorter incubation time and being able to use that animal with a particular transgene. We don't know exactly what the perfect transgene is, for instance, for BSE. One of the problems we have encountered is that, while we could make a transgene that was a chimera between mouse and human, when we made approximately the same chimera with cow it did not work. So, there is an issue of using mice with a species-specific protein X involved in the formation of PrP<sup>Sc</sup> and finding the right combination of sequences that allows binding to this protein X in the most efficient way and yet permits a readout of a foreign prion — whether this comes from human, cow, or sheep. I think this is a problem that is going to require a lot of additional work in the future.

**Question for Dr. Brown:** How long before one sees clinical signs in a CJD patient is the individual manifesting infectious prions in the brain or in body fluids?

**Answer Dr. Brown:** We don't know in humans. Studies by William Hadlow in naturally-infected sheep showed that infectivity shows up in peripheral organs first associated with the intestinal tract, the tonsils, the intestine, and then in the spleen long before infectivity is detectable in the brain. This observation is from sheep that will become symptomatic in about 2 to 3 years with measurable infectivity — not just infectivity inferred from PrP — in these peripheral organs 10 to 12 months after the infection has occurred if it's an experimental infection or after the birth of the animal in an infected flock. So, peripheral infectivity in environmentally-acquired scrapie occurs well before anything is clinically evident. Perhaps we can make the same assumption for human CJD acquired environmentally. I think we can make no assumption about sporadic CJD if it arises *de novo* in the brain.

**Comment by Dr. Schreuder:** I would like to comment on the scrapie investigations we did on the tonsil biopsies. Starting from about 4, 5, and 6 months, you get positive signals in animals that become ill.

**Comment by Dr. Brown:** That is actually a very important question with respect to blood. One wonders if blood is infectious in a patient with CJD, how long before CJD becomes evident is infectivity detectable in the blood. Based on iatrogenic disease, the

estimate is about 10 years; however, with sporadic CJD all bets are off since nobody knows.

**Question for the Panel:** Should autopsy instruments be discarded?

**Answer by Dr. Will:** The reason for discarding neurosurgical and ophthalmological instruments used in CJD cases is because of the possibility of disease transmission to other patients. Of course, that doesn't usually apply to autopsy instruments. There has been a great deal of concern among the neuropathological community about the potential risk to the neuropathologist through use of these instruments and through performing postmortems. Currently, the only way to define nvCJD cases with any certainty is to obtain a postmortem and look at the brain. I think it's important to recall that prior to 1968 and perhaps to the mid-'70s, no specific precautions were taken for performing postmortems on patients with CJD. Indeed, I myself have seen neuropathologists cutting up CJD brains without wearing gloves. Despite this, there is really no good overall evidence of a risk to a neuropathologist through examination of a CJD brain. It doesn't mean there isn't a risk but that there is no good evidence of increased risk. I think this observation is important because the perception of the general public is that because these agents are difficult to eradicate and so little is known about them, they must be highly contagious. I think the evidence suggests that that this is not the case, at least in the health care sector.

**Comment by Dr. Brown:** Well, Bob obviously put his finger on a major difference between autopsy instruments and instruments used in neurosurgery. The autopsy instruments are no longer a threat for living people but they do pose a threat to the pathologist. While there is no good evidence that neuropathologists are at higher risk for contracting this disease than the general population, there have been a few cases in neuropathologists and neuropathology technicians. These are anecdotes but they are worrisome anecdotes. We propose that brain tissues be put in 100% formic acid for 30 to 60 minutes before they are processed. The tissue turns translucent so it is necessary to put it back into formaldehyde before processing it. Using this method the brain tissue is (1) no longer infective, and (2) perfectly acceptable for neurohistology evaluation.

With respect to the question, I doubt that it is necessary to discard autopsy instruments. One, they are much more limited in number than instruments used by a neurosurgeon, and therefore it is easier to devote a set of autopsy instruments to high-risk cadavers if you choose. Two, I think the methods for decontamination are reasonably good if you are not having to deal with actually putting that same instrument back into the brain of a living patient.

**Question for the Panel:** Could the panel comment on a related issue concerning the reuse of laboratory glassware and tissue grinders exposed to CJD-infected matter? Is earlier research invalidated because of the extreme difficulties with inactivation? I think this is important with respect to autopsy of CJD patients because we try to use these tissues in experimental studies.

Single user license provided by AAMI. Further copying, networking, and distribution prohibited.

**Answer by Dr. Taylor:** Just one additional point, I agree with the conclusion that the risk



to the pathologist and other medical personnel is probably very small. But as has been indicated, sometimes we want to remove tissue from infected cadavers for experimental purposes. Under these conditions the instruments should be absolutely pristine. Therefore, you choose to use either new instruments or instruments that have been already used but sterilized by some of the sequential methods suggested by Dr. Brown.

**Comment by Dr. Will:** I would also like to add that one of the problems that has arisen because of all the publicity about these agents, at least in the United Kingdom, is a misunderstanding of the relative risk of being in contact with individual sufferers of CJD. This can have a rather major effect on the relatives if inappropriate actions are taken on a hospital ward, such as barrier nursing, destruction of bedding and cutlery after use, etc. None of these measures are really necessary, and there is no great evidence of any increased risk to the relatives of patients. I also think it is very important at burial that no excess precautions are taken. In one of the nvCJD cases, the family was extremely upset because a very deep grave was dug and it was lined. When the family arrived, all the staff of the mortuary were wearing gear, masks and such. So there is the possibility, because of the uncertainty with this disease and particularly with nvCJD, of excessive measures being taken which are very distressing to already distressed people.

**Comment by Dr. Lederberg:** If I might make a comment on the scientific and technical basis for decontamination. One would ordinarily not be reverting back to a theoretical approach, but we have seen the difficulties of purely empirical approaches to, for example, what temperatures or autoclave pressures to use. I'd like to argue for a return to first principles. Heat and steam will denature proteins, but under normal conditions they act very slowly to break covalent linkages. We're dealing with materials which are obviously very resistant to breakdown in its secondary structure. Sodium hydroxide hydrolyzes peptide linkages. I think we ought to start looking at protocols which have a theoretical scientific basis in terms of destroying the intrinsic covalent structure of our targets and then build the decontamination procedures on those sets of principles. They've been mentioned empirically by tandem procedures, but let's put some real science into it.

**Question for Dr. Taylor:** Gamma radiation was noted as not being effective in inactivating spongiform encephalopathies. What were the absorbed doses in joules per kilogram?

**Answer by Dr. Taylor:** I can't answer in units of joules per kilogram. I know that in terms of the old megarad exposure, you get survival of some infectivity after about 40 megarads of gamma radiation — that's a very high dosage.

**Comment by Dr. Brown:** Most of the irradiation experiments were performed 15 to 20 years ago. The answer to this question is published. Certainly, one of the first was performed by T. Alper in 1967. Shortly after that, there was a publication out of our laboratory in collaboration with a French physicist that has specific joules per kilogram data. I believe that Dr. Prusiner's laboratory also did an irradiation experiment on purified PrP within the last 6 or 7 years that would have exact numbers in it.

**Question for Dr. Brown or Dr. Taylor:** With some work done on chlorine dioxide as a gaseous sterilant, the question is raised by the data you presented on the chlorine content of hypochlorite decontamination.

**Answer by Dr. Brown:** The chlorine dioxide was a liquid proprietary preparation sold under the brand name of Alcide™. It didn't work and we have not done anything more on it.

**Question for Dr. Taylor:** What was the pH at which the disinfection experiments were performed? Was the chlorine used as sodium hypochlorite or as a commercial preparation stabilized at high pH with sodium hydroxide?

**Answer by Dr. Taylor:** It was a proprietary hypochlorite compound, freshly obtained, and titrated to determine the absolute chlorine content. I don't know what the pH was. It's a standard product and was used as recommended.

**Comment by Dr. Brown:** One should recognized that bleach in the United Kingdom is stronger than bleach commercially sold in the United States. We had to go to a commercial firm to get industrial-strength bleach to do our experiments.

**Comment by Dr. Taylor:** In the United Kingdom you can readily buy proprietary hypochlorite products with a concentration of 10 to 12%.

**Comment by Dr. Brown:** Chlorox in the United States is 5% and if you open it and leave it around, it goes down to 1% in a few months.

**Question for the Panel:** What were the concentrations of peracetic acid? Has microwave been used on brain tissue with high lipid content?

**Answer by Dr. Taylor:** We ran up to 18% with peracetic acid with no effect on tissue homogenates. We did, in fact, get some effect with, I think, 2 to 4% with intact tissue. I would interpret this as being indicative of demonstrating a potential protective effect of aggregation which could occur in homogenates but not in intact tissue.

With respect to the latter question, we worked on intact brain and 10% homogenates exposed to microwave irradiation and there was very little effect.

**Question for Dr. Taylor.** The whole story looks very similar to results obtained on biofilms, where microorganisms embedded in a protective matrix become highly resistant to sterilization — and even more so after fixation. What are the protective effects of the surrounding tissue? What about the effect on purified PrP?

**Answer by Dr. Taylor:** I will answer the last part of your question first. I have deliberately avoided both in my work and in my presentation discussing inactivating effects of physical or chemical agents on partially purified prions because I largely expect to be carrying out work that is relevant to everyday inactivation. There have been some studies of chemical and physical agents on partially purified infectivity. In general you'll get slightly more enhanced degrees of inactivation by some of the chemicals I perhaps would have

listed as not having sufficient effect. I qualify that by meaning not sufficient effect with crude tissue and everyday inactivation levels. I take your point of what you are saying about biofilms about which I don't know a great deal. But, I will just say that the design of the experiment where we get smearing and drying of infectivity under glass surfaces make no apology for because I would argue that these actually mimic everyday conditions that will prevail and you will have to deal with. I am certainly aware that similar statements can be made for conventional microorganisms in terms of an enhanced resistance on smearing and drying.

**Question for Dr. Taylor from the Floor:** Your results are often cited when inactivation on bovine material used, for example, in the pharmaceutical fields are applied for partially purified or strongly purified preparations. How would that apply?

**Answer by Dr. Taylor:** As you imply, the conditions under which my experiments are done may well be far more rigorous than you might have to deal with in everyday practice in biopharmaceutical manufacturing. I can't help that and I can't tell you how to interpret my data in terms of what would seem to be less exacting conditions which is why the companies that do validation studies have been profiting quite well from this last round of concerns. So, I really have no way of answering your question.

**Comment by Dr. Brown:** Earlier today validation studies came up in our discussion. Dr. Taylor showed you that in double autoclaving, the second autoclaving doesn't have a whole lot more effect than the first one did and the phenomenon of a subpopulation of resistant particles, whatever they are, was raised and this is just a warning to companies that like to take a process that has five steps, spike each process, and then say: ah hah, we have four logs here, two logs here, three logs here, we'll add them all up. We've got twelve logs of inactivation — forget it, we're as safe as we can be.

That same subpopulation may resist all five steps and what you really want to know is what goes in and what comes out at the end. It's nice to do both but it's not a legitimate strategy to add up clearance infectivity titers for step after step after step, a mistake that a lot of you folks make.



# Session III

## Emerging Sterilization Issues & Technologies

**Eamonn V. Hoxey, Ph.D.**

**Chairman:** *Device Technology and Safety, Medical Devices Agency,  
U.K.*



# Introduction Emerging Sterilization Issues & Technologies

Eamonn V. Hoxey Ph.D.

*Device Technology and Safety, Medical Devices Agency, U.K.*

Sterilization technology is a mature science. The use of inimical agents for decontamination predates the identification of microorganisms as causes of infection; Homer's *The Odyssey* records the use of burning sulphur for the fumigation of rooms [1]. With the increasing understanding of microbiology, Pasteur [7] recognized that temperatures in excess of 100°C were required to sterilize fluids and Kilmer's paper of 1897 [2] identified saturated steam as the method of choice for the sterilization of dressings.

Sterilization is achieved by the application of a defined and validated sterilization process. For the widely accepted sterilization methods, the variables that influence the effectiveness of the method are well recognized and advances in sterilization technology have been aimed at process optimization. For the established sterilization processes, standards specifying the requirements for validation and routine control have been developed and represent a consensus of best practices [3-5].

In addition to the established methods, however, there are a range of emerging technologies employing novel sterilizing agents or combinations of agents that are under investigation or are beginning to be used in practice. Therefore, to complement these published standards, a further document is in preparation to establish requirements for sterilization processes for which no specific standard exists. This standard, ISO 14937, 'Sterilization of Medical Devices — General Requirements for the Characterization of a Sterilizing Agent and the Development, Validation and Routine Control of a Sterilization Process' [6] is currently at the Committee Draft stage for ballot in the International Standards Organization (ISO). ISO 14937 seeks to use the experience gained during the development of those sterilization processes that are now established to identify the requirements for the development, validation, and routine control of emerging sterilization processes. Application of these requirements during development should assist in gaining the confidence of manufacturers, users, and regulatory authorities in the effectiveness of these emerging processes.

ISO 14937 is organized into the following sections:

- *Quality system* — provides the mechanism to control all stages of the sterilization process through development, validation, and routine application. This includes the quality system elements that control personnel, documentation, record keeping, review procedures, and corrective actions.
- *Sterilizing agent characterization* — defines the sterilizing agent and its microbicidal effectiveness. This includes specifying the sterilizing agent, demonstrating its microbicidal effectiveness, investigating the effect on materials of exposure to the

sterilizing agent, and considering the safety of personnel and the environment.

- *Process/equipment characterization* — defines the overall sterilization process and the equipment necessary to carry it out safely and reproducibly. This comprises defining the process parameters and specifying the equipment.
- *Product definition* — defines the product to be sterilized and its bioburden. This includes specifying the product and its packaging as well as the microbial quality of the product prior to sterilization.
- *Process definition* — defines the process to be applied to sterilize identified products while maintaining the safety and performance of those products. This covers process development and the demonstration that the product is compatible with the sterilization process, including aspects of biocompatibility and the effects of repeated application of the sterilization process, if this is to be permitted.
- *Validation* — demonstrates the effectiveness and reproducibility of the defined sterilization process. Validation is subdivided into installation qualification, operational qualification, performance qualification, and the review and approval of the validation documentation.
- *Routine control and monitoring* — demonstrates that the validated process has been delivered within defined tolerances. This includes the controls on the manner in which product is presented for sterilization, the monitoring of the process, and the generation of appropriate records.
- *Product release from sterilization* — comprises the review of records of the routine monitoring and determines the disposition of product. This includes review of the processing records, the testing of indicators, the appropriate disposition of products and, if necessary, corrective actions.
- *Maintaining process effectiveness* — demonstrates the continued acceptability of the validated sterilization process. This includes routine controls of presterilization microbial quality, calibration, equipment maintenance, and requalification.

This session of the 1998 International Kilmer Memorial Conference will address issues in sterilization technology which are emerging with the established processes and will report on the progress with the development of processes which are not yet widely established. The papers in this session consider aspects of the development, characterization, validation, and routine control of sterilization processes.

Aspects of process definition will be addressed by Alan Tallentire with respect to radiation dose setting and substantiation, while Tom Lynch will discuss specific considerations for product definition for products of biological origin. Nigel Halls' paper on trends of increasing resistance in biological indicators considers implications for process definition and validation. Sterilizing agent characterization will be considered for low temperature sterilization methods by Bill Rutala, for chlorine dioxide by John Kowalski, and for vapor phase hydrogen peroxide by Tom May. In the final paper, Tim Ulatowski will provide an update on progress towards an international agreement on regulatory requirements for medical devices.



# References

1. Homer. *The Odyssey*, Homer (with an English Translation by A. T. Murray). 2nd edition. Cambridge (MA): Harvard University Press; 1995.
2. Kilmer F. Modern surgical dressings. *Am J Pharmacy* 1897;69:24-39.
3. International Standards Organization (ISO). *ISO 11134 Sterilization of Healthcare Products — Requirements for Validation and Routine Control — Industrial Moist Heat Sterilization*. Geneva: ISO; 1994.
4. International Standards Organization (ISO). *ISO 11135 Medical Devices — Validation and Routine Control of Ethylene Oxide Sterilization*. Geneva: ISO; 1994.
5. International Standards Organization (ISO). *ISO 11137 Sterilization of Healthcare Products — Requirements for Validation and Routine Control — Radiation Sterilization*. Geneva: ISO; 1995.
6. International Standards Organization (ISO). *ISO CD 14937 Sterilization of Medical Devices — General Requirements for the Characterization of a Sterilizing Agent and the Development, Validation and Routine Control of a Sterilization Process*. Geneva: ISO.
7. Vallery-Radot. *The Life of Pasteur* (Translated by Devonshire R L). New York: Doubleday; 1926.



# **Radiation Dose Setting/Substantiation Methods: Have We Got It Right?**

Prof. Alan Tallentire

*Air Dispersions Ltd., U.K.*

# Introduction

The International and European standards for the validation and routine control of sterilization by ionizing radiation, ISO 11137 [6] and EN 552 [5], respectively, were prepared virtually simultaneously, but separately, by two technical committees in the early 1990s. During the preparation process, liaisons were formally established between the committees to ensure on-going contact, which also occurred informally through several national representatives enjoying dual membership of the committees. In these circumstances, it is understandable that the standards have essentially the same content in their normative sections.

In developing the requirements dealing with the choice of sterilization dose, full account was taken of established industry practices. Consequently, both standards allow one of two possible approaches to be used for the selection of a minimum radiation dose to achieve sterility.

The first of these approaches is what may be described as *rational*. It is based on a knowledge of the number and the resistance to radiation of contaminating microorganisms that occur naturally in or on product, and a prediction of the dose needed to achieve a predetermined target standard of sterility or sterility assurance level (SAL). Because this dose is particular to a given product and its inherent microbial population, it is referred to as a product-specific sterilizing dose in EN 552.

To allow the rational approach to be taken into practice, two procedures of sterilization dose determination, designated Method 1 and Method 2, have been developed; they are described in detail in Informative Annex B of ISO 11137. The methods are refined versions of the dose setting Methods B1 and B2 which originally formed part of the 1984 AAMI publication 'Process Control Guidelines for Gamma Radiation Sterilization of Medical Devices' [1] and latterly of the 1991 ANSI/AAMI Standard 32 'Guideline for Gamma Radiation Sterilization' [2]. In preparing ISO 11137 and EN 552, both technical committees perceived Methods 1 and 2 as the principal means of implementing the rational approach to sterilization dose selection. Applying either of the methods requires relatively large numbers of dedicated product units and, consequently, their use in practice is restricted to product manufactured regularly in large quantities.

The second approach to selection of a sterilization dose may be termed *traditional*; it requires that product be treated with a minimum dose of 25 kGy, a level that historically has been considered to provide an effective sterilization treatment. Both the European and International standards require evidence to demonstrate the effectiveness of this dose; in other words, 25 kGy has to be substantiated. In stipulating this requirement, several general ways for the generation of the necessary evidence were perceived, the choice depending primarily on the quantity of product manufactured.

For product manufactured in large numbers (more than 1000 product units), the principal envisaged method of substantiation was performing a dose setting exercise employing either Method 1 or Method 2 of ISO 11137. Provided that the outcome of the exercise was the establishment of a sterilization dose that is less than 25 kGy, the latter may be considered to have been substantiated. For product manufactured in small quantities, either

as a single batch or as batches produced infrequently, substantiation using Method 1 or 2 is not practicable due to the relatively high number of product units needed to perform a dose setting exercise. Under these circumstances, it was thought that substantiation would generally be sought by applying a method that is an adaptation of Method 1. This adaptation was first documented in ANSI/AAMI Standard 32—1991 under the designate ‘Method 3’ [2]. Because of the relative lack of experience in applying this method, however, it was not included in the Informative Annex of ISO 11137, but rather became the basis for the development of a procedure for substantiation of 25 kGy for inclusion in an ISO Technical Report (type 2), “a prospective standard for provisional application”. Making the method available in this form allows information regarding its use to be gathered before formal consideration is given to conversion to an International standard. This Technical Report was published in 1996 as ISO/TR 13409 [7].

It is relevant to note that Working Group 2 (WG2) of Technical Committee 204, charged with developing the European radiation sterilization standards, has recently recommended on technical grounds that ISO/TR 13409 should not be adopted in the European standards system. For circumstances where Method 1 or 2 cannot be used for substantiation purposes, EN 552 instead provides general guidance on how to develop evidence to support the effectiveness of a 25 kGy sterilization dose. Experience gained in implementing this aspect of EN 552, however, has revealed that the guidance provided is inadequate and is in need of elaboration and revision.

Table 1 provides an overview of options for, and methods of, dose setting/substantiation that are detailed in ISO 11137 and EN 552, together with the perceived areas of applicability. While ISO 11137 and EN 552 both recognize that there may be methods and procedures other than the ISO methods that are capable of achieving compliance with the dose setting/substantiation requirements, the reality is that the onus of meeting these requirements resides principally with Method 1 and 2 and that of ISO/TR 13409. This is even more likely to be so in the future.

Revision of the two standards and evaluation of the Technical Report are due soon and, if past events are any indication, an appreciable part of these future activities will be devoted to reappraisal of dose setting/substantiation needs and methods. Now would seem to be an appropriate time to commence this process. As a first action, we should pose and answer the ‘high level’ questions, “What evidence is there to show that dose setting/substantiation methods are reliable and safe?” and “Are the methods in their current form equipped to perform the task being asked of them?”. Several investigators are addressing, by theoretical and experimental means, certain aspects of these questions; the present report describes some of their recent findings.

**Table 1. Dose Setting/Substantiation Options and Requirements Specified in EN 552 and ISO 11137, Methods to Meet the Requirements, and Applicabilities**

Option	Requirement	Method of Dose Setting/Substantiation	Minimum Number of Product	Applicability
Product-specific sterilizing dose (Rational)	Dose setting	Method 1 Method 2	130 640	Large batch sizes of inexpensive product

25 kGy (Traditional)	Dose substantiation	Method 1	130	Large batch sizes of inexpensive product
		Method 2	640	
		Method TR	20-100	Small batch sizes (<1000)
		EN 552 Guidance	-	-

---

# Dose Setting/Substantiation Methods

The distinguishing feature of the three ISO methods of dose setting/substantiation is that each involves a measurement, by experimental means, of the resistance to radiation of the microbial population that is present naturally on or in the product. In order to carry out this measurement, the methods utilize a) the population as it occurs *in situ* in or on the product, and b) the test of sterility performed on individual product units which have been exposed to a radiation dose that is a fraction of the sterilization dose. Scoring such tests for positives allows a measure of resistance to be obtained that, in turn, provides a basis for predicting the sterilization dose.

## *Method 1*

Method 1 requires a knowledge of the average bioburden of the product; it also requires the performance of an experiment to verify, at an SAL of  $10^{-2}$ , that the resistance to radiation of product microbial population is equal to or less than that of a population having what is now known as the Standard Distribution of Resistances (SDR), the dose for verification being specified by the SDR and the bioburden level. The SDR was deliberately chosen as the comparator population since its resistance is considered to be greater than those possessed by microbial populations generally found on product units that are to be radiation sterilized. Subject to verification, the SDR, together with the bioburden level, is used to predict the radiation dose to maximally give an SAL of  $10^{-6}$  (the sterilization dose).

## *Method 2*

Method 2 aims to provide an exact value for the sterilization dose (i.e., a dose which achieves an SAL of  $10^{-6}$ ). It requires that product units are exposed to series of increasing incremental doses prior to the performance of a test of sterility on each irradiated product unit. The data derived from the tests allow estimates to be made, for the particular product under consideration, of the dose to achieve an SAL of  $10^{-2}$  and of the  $D_{10}$  value of microorganisms surviving that dose. The estimates are used to extrapolate the relationship between SAL and dose to values of SAL below  $10^{-2}$  and, in so doing, predict the sterilization dose for the specific product.

## *Method for Substantiation of 25 kGy (Method TR)*

The method for substantiation of 25 kGy given in ISO/TR 13409 (hereafter, for convenience, referred to as Method TR) is an adaptation of Method 1. It employs a verification procedure similar to that used for Method 1 in order to examine the resistance of the product microbial population relative to that of the SDR. For verification, a predetermined value of SAL, in the range  $10^{-2}$  to  $10^{-1}$ , is used, the exact value taken by SAL, together with the bioburden level and the SDR, specifying the verification dose. Passing the verification procedure, which is indicative of product microflora of resistance equal to or less than the SDR, substantiates a sterilization dose of 25 kGy. Method TR is

limited to product having a bioburden of less than 1000. This requirement is set because the SDR is the basis of Method TR. A microbial population comprising the SDR at a bioburden level of 1000 exhibits an SAL of  $10^{-6}$  at a dose close to 25 kGy and thus, it is argued that microbial populations of below 1000, which meet verification, will provide values of SAL less than  $10^{-6}$  after an exposure to 25 kGy.



# Standard Distribution of Resistances

A basic premise underlying dose setting/substantiation Methods 1 and TR is that a microbial population possessing the so-called SDR represents a more severe challenge to the radiation sterilization process than the natural microflora normally present on or in product units to be sterilized. The SDR is a hypothetical distribution made up of a series of increasing  $D_{10}$  values and associated decreasing probabilities of occurrence. Its basis is measurements of  $D_{10}$  values of selected microbial isolates obtained from components of an operating pack [11,12]. After consideration of these experimentally-derived data and other published data, Davis *et al.* [3] fashioned the SDR for general application. With a widening use of the ISO methods internationally, the appropriateness of the SDR as a comparator distribution and a standard for dose setting is being reexamined.

As part of this reexamination, experimental work similar in design to that done originally [11,12] has recently been carried out in the United Kingdom [14]. The conditions and methods employed in this recent study followed as closely as possible those used to obtain the original  $D_{10}$  measurements and, thus, direct comparison between the outcome of the work and SDR is appropriate. The study consisted of generation of a distribution of  $D_{10}$  values for selected radiation resistant microorganisms isolated from a single product, bleached cotton gauze, chosen because it has a moderate bioburden level with a high proportion of bacterial spores. The observed distribution, compiled from the raw data, took a form not unlike that of the SDR. Positive deviations from the SDR were relatively small. Deviations that did occur were not at the highest  $D_{10}$  values and as a consequence, the overall resistance of the isolated microorganisms was somewhat less than that of the SDR. The latter finding is reassuring and supports the earlier contention that the SDR is a severe challenge to the radiation sterilization process which, when accessed for selection of a sterilization dose, gives a dose that is 'safe'.

It is also relevant to note here a distribution of resistances, the outcome of a recent Japanese investigation, that exhibits an overall resistance somewhat higher than that of the SDR [9]. The distribution was developed using techniques deliberately chosen to closely follow those used by others working in this field. However, the distribution was compiled from pooled data derived from isolates obtained from a number of different types of products manufactured at a number of centers. Moreover, a recent report has pointed out that the methodology used to determine the resistances of isolates has given an 8 to 10% overestimate of  $D_{10}$  values for about one-third of the isolates [13]. In these circumstances, caution has to be exercised in analyzing and assessing the Japanese finding in the context of the appropriateness of the SDR for dose setting purposes.

# Computer Evaluations of Dose Setting/Substantiation Methods

When Method 2 was devised and its operational protocol detailed as a series of standardized procedures, it underwent an exhaustive evaluation to establish its ability to select a correct sterilization dose [4]. The evaluation was performed using computer simulations of the method that fully mimicked the dose setting procedural steps and in which numbers and radiation resistances of contaminating microorganisms varied widely and incremental doses were varied to levels typical of those seen in practice. Very good agreement was generally obtained between the dose selected through simulation and the dose calculated to achieve sterility. The reporting of the results of this evaluation in the open scientific literature in 1984 [4] was without doubt largely responsible for the wide recognition of Method 2 as a well-founded and safe method of dose setting when the method was published in the AAMI guideline in the same year.

Rather surprisingly, no comparable evaluation has been reported for Method 1 or its adaptation. Computer evaluation of these methods is expected to provide a deeper and fuller understanding as well as offering a means of examining their ability to detect very low numbers of microorganisms of high radiation, an issue of particular concern to some in the past [10]. Some results of an on-going evaluation study on Methods 1 and TR are summarized below.

## *Evaluation Methods*

In performing the evaluations, the dose setting/substantiation methods were, in effect, challenged with a series of different hypothetical microbial populations. The populations, each characterized by the overall number of microorganisms and the resistances to radiation ( $D_{10}$  values) of the individual types that make up the number, were set up within a computer program designed to define the inactivation of a given population by radiation. When run, the program provided the computed value of SAL achieved at the dose for verification and that value achieved at the sterilization dose. If the computed value of SAL equals or takes a value below the 'target' SAL for the particular dose, the outcome of the challenge is regarded as Pass (P) and, if it takes a value above the target, the outcome is regarded as Fail (F).<sup>1</sup>

## *Interpretation of Results*

The separate outcomes from the challenge (P or F) for both the verification dose (VD) and the sterilization dose (SD) are combined to signify whether or not, overall, the method handles the challenge in a 'safe' manner. Thus, for dose setting using Method 1, there are potentially four outcomes:

**P - P**, representing an  $SAL_{VD} \leq 10^{-2}$  and an  $SAL_{SD} \leq 10^{-6}$  and regarded as 'safe';

**F - F**, representing an  $SAL_{VD} > 10^{-2}$  and an  $SAL_{SD} > 10^{-6}$  and regarded as 'safe';

**P - F**, representing an  $SAL_{VD} \leq 10^{-2}$  and an  $SAL_{SD} > 10^{-6}$  and regarded as 'unsafe';  
and

**F - P**, representing an  $SAL_{VD} > 10^{-2}$  and an  $SAL_{SD} \leq 10^{-6}$  and regarded as 'safe'.

Similarly, four such outcomes can describe the overall performance of dose substantiation Method TR. However, for this activity, the target SAL at verification ( $SAL_{VD}$ ) takes a value in the range  $1.11 \times 10^{-2}$  to  $10^{-1}$ , depending upon the number of product units employed for verification, and the target SAL for sterilization ( $SAL_{SD}$ ) is  $10^{-6}$  at 25 kGy (i.e.,  $SAL_{SD}$  becomes  $SAL_{25}$ ).

Furthermore, in the context of the present work, a method is regarded as 'reliable' if it possesses the ability to distinguish, at the verification SAL, the microbial population with a resistance greater than or less than the SDR.

# Resistance Distributions

In applying Methods 1 and TR, the SDR establishes the level of resistance against which the resistance of the microbial population on product is compared and, subject to verification, it effectively sets the sterilization dose. Thus, it seemed proper and logical to include in the evaluation process challenge populations whose resistances varied in differing degrees from that of the SDR. Accordingly, distributions were created to provide, in a graded manner, challenges that progress from being more sensitive to being more resistant than the SDR. They were produced solely by direct modification of the SDR and are therefore referred to as the Modified Distributions. In all, there were 54 of these distributions, comprising nine groups of unequal size. Each group was developed by successive summations of probabilities of  $D_{10}$  values that make up the SDR.

Table 2 depicts the manner in which the grouped distributions were created; for comparative purposes, the SDR is reproduced at the head of the table.

- Group 1 comprises two distributions in which the probabilities for the first eight values of  $D_{10}$  of the SDR are unaltered, and the probabilities for the two remaining high  $D_{10}$  values have been summed; this summed probability has been located separately in each of the two high values of  $D_{10}$  to give modified distributions MD1 and MD2.
- Group 2 comprises three distributions in which the probabilities for the first seven values of  $D_{10}$  of the SDR are unaltered and the probabilities for the remaining three high  $D_{10}$  values have been summed and the summed probability located in each of the three high  $D_{10}$  values to give MD3, MD4, and MD5.
- The remaining groups, 3 through 9, were developed in a similar way by amalgamating the probability of one further value of  $D_{10}$  for each successive group.

It is interesting to note that the first modified distribution within any one group has an average resistance that is less than that of the SDR, whereas all of the remaining distributions in the group exhibit greater average resistances than the SDR.

In addition to the resistance distributions created by modifying the SDR, five other distributions were used to challenge Method 1 and Method TR. They corresponded to Populations A, B, D, E, and F employed by Davis *et al.* [4] in the computer evaluations of Method 2. These five were originally chosen because it was thought that they represented microbial populations on product units. Populations A and B possessed overall resistances which were less than the SDR, whereas those of Populations D through F were markedly greater. It was felt that their use as challenges could give an indication of the ability of the methods to handle relevant populations.

# Method 1

Method 1 was challenged with microbial populations of different size, extending from 0.1 to 1021, having the entire range of resistance distributions described above. As an example of output derived from a series of such challenges, Table 3 displays the results of evaluations that specifically addressed the crucial issue of the ability of the method to detect and correctly respond to populations possessing a small number of microorganisms of high radiation resistance. The challenges were defined by modified distributions belonging to groups 1 to 4 that gave populations possessing a proportion of microorganisms of high radiation resistance ( $D_{10} \geq 3.1$  kGy) ranging from a low of 0.079% to a high of 1.326%. The notable findings are:

**Table 2. Manner in Which Modified Distributions were Created and Formed into Groups. Tabulated Values are Probabilities Corresponding to Individual  $D_{10}$  'Classes' of the SDR**

Dist.		$D_{10}$ kGy									
SDR		1.0	1.5	2.0	2.5	2.8	3.1	3.4	3.7	4.0	4.2
		.65487	.22493	.06302	.03179	.01213	.00786	.00350	.00111	.00072	.00007
Group		$D_{10}$ kGy									
		1.0	1.5	2.0	2.5	2.8	3.1	3.4	3.7	4.0	4.2
1	MD1*	.65487	.22493	.06302	.03179	.01213	.00786	.00350	.00111	.00079	0
	MD2				ditto					0	.00079
2	MD3	.65487	.22493	.06302	.03179	.01213	.00786	.00350	.00190	0	0
	MD4				ditto				0	.00190	0
	MD5				ditto				0	0	.00190
3	MD6	.65487	.22493	.06302	.03179	.01213	.00786	.00540	0	0	0
	MD7				ditto				.00540	0	0
	MD8				ditto				0	.00540	0
	MD9				ditto				0	0	.00540
4	MD10	.65487	.22493	.06302	.03179	.01213	.01326	0	0	0	0
	MD11				ditto			.01326	0	0	0
	MD12				ditto			0	.01326	0	0
	MD13				ditto			0	0	.01326	0
	MD14				ditto			0	0	0	.01326

↓  
continued

\* MD1 refers to Modified Distribution 1, MD2 refers to Modified Distribution 2, etc.

- At relatively moderate population sizes (tens of microorganisms) and above, the method is generally operating as intended; the outcomes are 'safe'. Such outcomes are P - P or F - F, the P - P outcomes being associated with populations that are less resistant than the SDR and the F - F outcomes with those that are more resistant than the SDR.
- As population size is decreased, P - F outcomes, which are regarded as 'unsafe', are seen; they occur most frequently at the smallest population size examined. The 'unsafe' outcomes are obtained with these populations because the numbers of microorganisms of high resistance within the challenges are not sufficient to generate

'F' outcomes on verification, yet they are sufficient to provide an 'F' at sterilization doses. As noted above, with larger size populations having the same resistance distribution, F - F outcomes occur, presumably because the numbers of microorganisms of high resistance within these challenges are sufficient to give 'F' outcomes at both verification and sterilization doses. It is worth noting here that P - F outcomes were restricted to challenge populations derived from modified distributions within groups 1 to 4. When evaluations of Method 1 were extended to include populations developed from modified distributions in groups 5 to 9, thereby possessing a proportion of radiation-resistant microorganisms appreciably greater than 1.32%, 'safe' outcomes were seen for all of the resistance distributions and for all population sizes examined.

c) Occasionally, F - P outcomes are evident. An outcome of this type indicates failure on verification yet achievement of an SAL of  $10^{-6}$  or less at the sterilization dose. Because of the latter, the F - P outcome is deemed 'safe' but, in effect, might be better classed as 'incorrect' due to its failure to correctly inform at verification the achievement at the sterilization dose. While the occurrence of F - P is low for this limited series of challenges, it increases appreciably when the series is extended to include those modified distributions belonging to groups 5 to 9. In these circumstances, up to one-tenth of the outcomes can be F - P. The occurrence of this particular outcome is apparently linked with the presence in the challenge of a relatively high proportion of microorganisms having mid-region  $D_{10}$  values (2.0 to 2.8 kGy).

**Table 3. Overall Outcomes of Method 1 Evaluations for Microbial Populations Having Resistances Differing Marginally From Those of the SDR (Modified Distributions 1-14)**

		Summed Prob.	$D_{10}$ 'class' (kGy)	Population size				
				0.10	1.05	10.69	104	1021
Group 1	MD1	.00079	4.0	P - P	P - P	P - P	P - P	P - P
	MD2		4.2	P - F	P - F	P - F	F - F	F - F
Group 2	MD3	.00190	3.7	P - P	P - P	P - P	P - P	P - P
	MD4		4.0	P - F	F - F	F - F	F - F	F - F
	MD5		4.2	P - F	F - F	F - F	F - F	F - F
Group 3	MD6	.00540	3.4	P - P	P - P	P - P	P - P	P - P
	MD7		3.7	P - F	F - F	F - F	F - F	F - F
	MD8		4.0	P - F	F - F	F - F	F - F	F - F
	MD9		4.2	P - F	F - F	F - F	F - F	F - F
Group 4	MD10	.01326	3.1	P - P	P - P	P - P	P - P	P - P
	MD11		3.4	P - F	F - F	F - P*	F - P*	F - P*
	MD12		3.7	F - F	F - F	F - F	F - F	F - F
	MD13		4.0	F - F	F - F	F - F	F - F	F - F
	MD14		4.2	F - F	F - F	F - F	F - F	F - F

Notes: Boxes highlight P - F outcomes which are 'unsafe'; \* identifies F - P outcomes which are 'safe' but 'incorrect'

From a consideration of the totality of evaluations, the conclusion is that Method 1 is generally a reliable and safe method for establishment of a sterilization dose. Other than in highly specialized circumstances, the method is able to distinguish, at the verification SAL, microbial populations with a resistance less than or greater than the SDR; furthermore, for populations of less resistance, the method provides safe sterilization doses (doses achieving values of  $SAL \leq 10^{-6}$ ), whereas, for those of greater resistance, it disallows the setting of what otherwise would have been inadequate doses.

The special circumstances with which Method 1 cannot effectively cope relate to microbial populations, low in number, possessing a small proportion of microorganisms of particularly high resistance. In practice, products with low average bioburdens undoubtedly occur and, should they be subjected to dose setting by Method 1, uncertainty with regard to the adequacy of the selected sterilization dose is inevitable. Perhaps then, consideration should be given to establishing a rationalized lower limit for the size of population for which Method 1 can be used. Effectively, the limit is now 0.06, the lowest value for average bioburden given in the procedural table (Table B.1) of Method 1. Present indications are that this value is too low for Method 1 dose setting. In seeking a rationalized lower limit, there will of course be a need for rigorous definition of the discriminating capabilities of Method 1 with small populations of microorganisms and perhaps, a need too for computer simulations of the whole procedure of the method for such populations. Also, if such a lower limit is established, a method of selecting the sterilization dose for products of average bioburden below the limit will have to be sought. Preferably, any new method to be applied to product of this kind has to be more economical with regard to product usage than Method 1 and at least as easy to perform. This is self-evident as products of low average bioburden are mainly a consequence of the application of proper quality systems during manufacturing and, if these operational criteria cannot be met, there is a distinct possibility that good practices will be discouraged.

# Method TR

A series of computer evaluations have been conducted with Method TR using challenge microbial populations defined by the same resistance distributions as those employed when challenging Method 1. For each resistance distribution, overall outcomes were obtained for seven population sizes, chosen to span at regular intervals the domains of bioburden levels specified for Method TR (1 to 10, 11 to 100, and 101 to 1000) and for four verification SAL values extending from  $1.11 \times 10^{-2}$  to  $10^{-1}$ , the particular values of SAL corresponding to verification test sample sizes of 90, 60, 20, and 10.

Crucially, in no instance was the unsafe outcome P - F observed. This general finding indicates that Method TR is a safe procedure for use in substantiating 25 kGy as a sterilization dose. Furthermore, a P - P outcome was always observed for populations with a size less than 1000 and of resistance less than the SDR; this is to be expected as microbial populations of 1000 comprising the SDR achieve an SAL of  $10^{-6}$  at 25 kGy. However, challenges with populations of resistance greater than the SDR frequently gave 'incorrect' outcomes. This is best exemplified by the findings from evaluations that employed the modified distributions.

The nine different groups of modified distributions, in which the distributions have a summed probability located successively in increasing classes of  $D_{10}$  value, yield outcomes that broadly take the same form with increasing  $D_{10}$  class. For the modified distribution within each group having the summed probability located in the lowest  $D_{10}$  class, the outcome is P - P for all challenge populations; this location gives an average resistance which is less than that of the SDR. Increasing the  $D_{10}$  class for the location of the summed probability, which gives an average resistance greater than the SDR, results in the appearance of F - P outcomes; the latter predominate with further increases in  $D_{10}$  class, then lessen, being replaced by the outcome F - F, for the location of the summed probability in high  $D_{10}$  classes. It should be noted that there is little or no effect on this general behavior with changing the SAL value. Figure 1 shows this behavior for modified distributions of groups 4 and 7 whose summed probabilities are 0.01326 and 0.12020, respectively. The orderly progression of the outcomes from P - P to F - P to F - F with changing location of the summed probability is clearly a consequence of increases in the radiation resistance of a fixed proportion of the challenge population, which, in turn, increases the probabilities of occurrence of a surviving microorganism at the verification test and at 25 kGy sufficient for them to exceed the respective target values of SAL.

Of consequence is the finding that F - P outcomes amount to almost 50% of the total outcomes that result from evaluations of Method TR utilizing modified distributions. For substantiation, F - P outcomes signify attainment at the verification test of an SAL greater than the target value and achievement of an SAL of  $10^{-6}$  or less at 25 kGy. As indicated above, such outcomes can be deemed 'incorrect', since through the outcome of the verification test they fail to correctly inform the appropriateness of 25 kGy as the sterilization dose. If Method TR were to be applied in practice under circumstances conducive to an F - P outcome, the result could be nonacceptance of the verification



experiment and failure to substantiate. In effect, the dose substantiation method would have failed to discriminate between microbial populations that can or cannot be sterilized by exposure to a dose of 25 kGy.

If the challenges used for the present evaluations bear any resemblance to those existing in practice then, on applying Method TR, a high frequency of 'incorrect' outcomes will occur. In such circumstances, Method TR cannot be regarded as an unerring and reliable method for substantiation of 25 kGy as the sterilization dose, in which case its overall value as a dose substantiation method has to be questioned. It is considerations such as these that have recently persuaded WG2 of Technical Committee 204 to recommend that ISO/TR 13409 not be made a part of the current European Standards system.

# **Predictive Link Between the Outcome of the Verification Dose Experiment and the Attainment of an $10^{-6}$ SAL at 25 kGy**

The reason for the high 'failure' rate with Method TR resides in a fault in its design. Failures result because Method TR provides no direct link between the outcome of the verification experiment and the attainment, or otherwise, of an SAL of  $10^{-6}$  or less at 25 kGy; doses specified for verification experiments are determined by the SDR, whereas the constant sterilization dose of 25 kGy is effectively independent of the SDR. This contrasts with Method 1 where the design is such that, subject to verification, the specific sterilization dose, characteristic of the bioburden level, is determined directly from the SDR. Clearly, for the outcome of a verification experiment to be meaningful, it has to be linked directly to the attainment of an SAL of  $10^{-6}$  or less at 25 kGy.

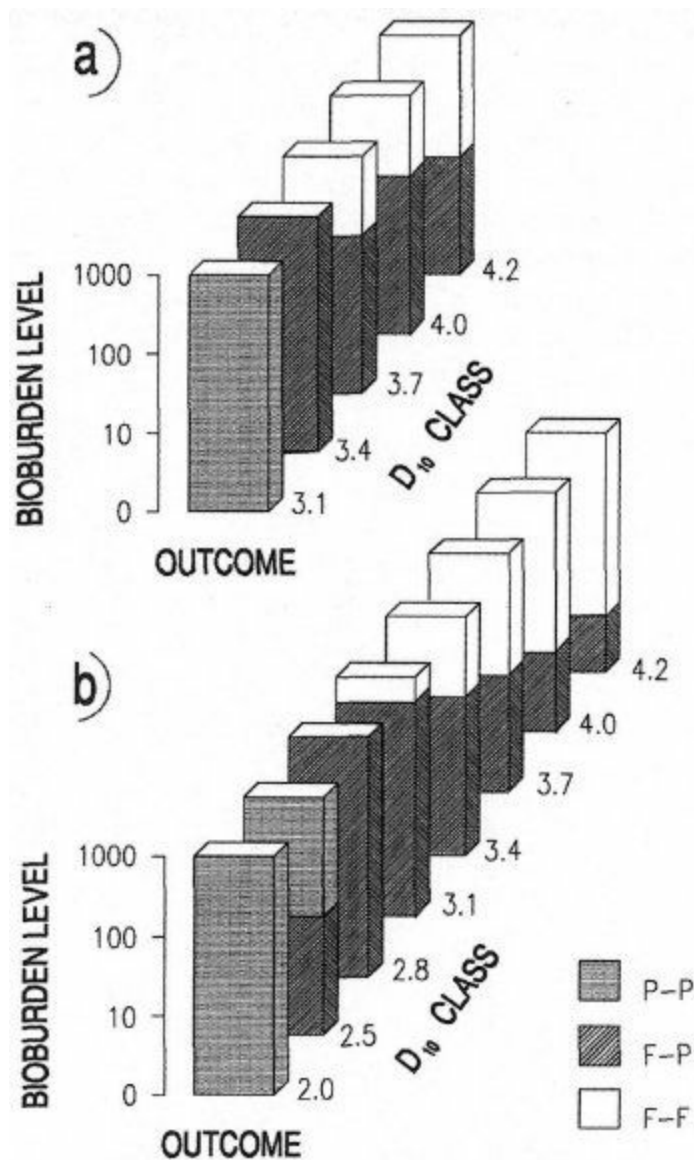

**Figure 1.** Outcomes of computer evaluations of Method TR as a function of the population size and  $D_{10}$  class possessing the summed probability for a) group 4 and b) group 7 modified distributions.

A recent collaborative study with Dr. John Kowalski of Johnson & Johnson has sought to identify how a link of this type can be made. Our starting point was an examination of the simplest and most obvious example of a direct link; this assumes linear kinetics for the inactivation of the microbial population. The response of a microbial population to radiation in these circumstances is described by a straight line passing through two points having coordinates,  $(\log n_0, 0 \text{ kGy})$  that defines the initial size of the population and  $(\log 10^{-6}, 25 \text{ kGy})$  that defines the sterilization objective. The curves given in Figure 2 represent responses of this type for populations of sizes differing by 10-fold amounts over the range 1 to 1000. Each curve is described by a  $D_{10}$  value (for identification purposes, denoted here by the symbol  $D_{lin}$ ) unique to the size of the population. In effect, the  $D_{lin}$  value specifies, for a particular population size, the maximal resistance that the micro-organisms comprising the population can take for an SAL of  $10^{-6}$  to be achieved with a dose of 25 kGy. Moreover, it

follows that, for the circumstances described here, the response defined by  $D_{lin}$  will determine the maximal dose that can be used for a verification experiment conducted at a particular SAL to substantiate 25 kGy. Thus, for each of the various population sizes given this simplistic treatment, the link between the verification experiment and the sterilization objective is both evident and explicit.

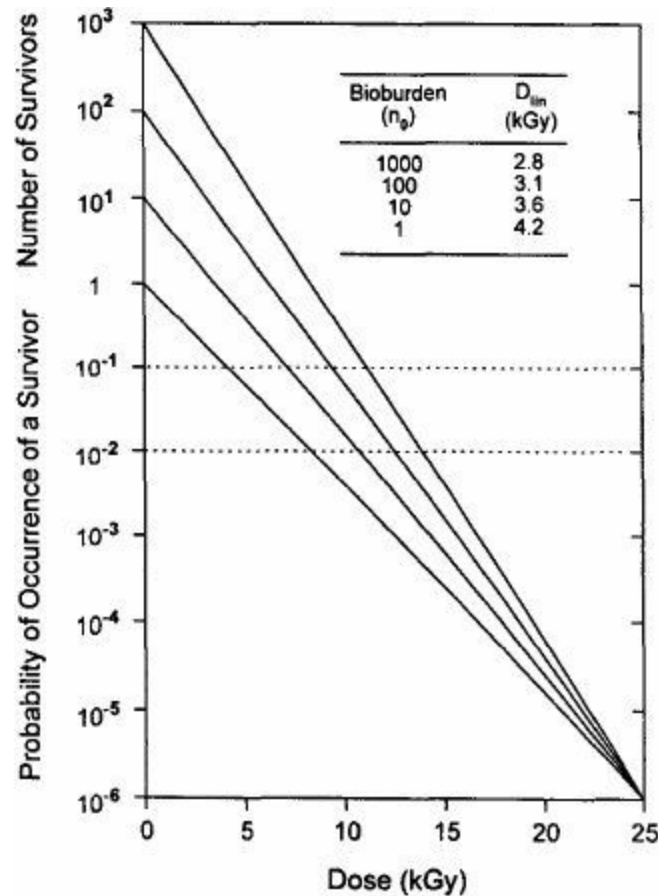

**Figure 2.** Linear radiation inactivation curves for populations of microorganisms of different sizes, each curve defining the response that achieves an SAL of  $10^{-6}$  at a dose of 25 kGy.

It is realized, of course, that  $D_{lin}$  values only describe the responses to radiation of populations comprising microorganisms that are homogeneous with respect to radiation resistance. In actuality, in almost all instances the resistances of product bioburden are heterogeneous, a fact that would seem to exclude consideration of  $D_{lin}$  as a basis for a meaningful predictive link. Nonetheless, we chose to assess the value of  $D_{lin}$  in this regard by examining whether or not the  $D_{lin}$  value, characteristic of a particular population size, could account for the radiation response of a typical heterogeneous population of the same size. In undertaking the examination, we elected to employ the SDR as the heterogeneous population, since it is regarded as a severe challenge to the radiation sterilization process and its response is used to set the sterilization dose in applying Method 1. The examination was carried out over the range of population sizes extending from 1 to 1000.

Familiarity dictated that we analyze SDR responses for different population sizes initially using a Method 1 model. Our aim was to obtain from the analysis a quantitative measure of

the functional part of the SDR response. Figure 3 gives, for illustrative purposes, the curves depicting the SDR responses (dashed lines) for microbial populations of sizes 1 and 1000 traversing the value of an SAL of  $10^{-2}$  employed for Method 1. The curves intersect the  $10^{-2}$  horizontal line at the respective verification doses, each denoted on the figure by the symbol 'VD'. Success with a Method 1 verification experiment effectively allows extrapolation of the SDR response below an SAL of  $10^{-2}$  in order to predict the sterilization dose required to achieve an SAL of  $10^{-6}$  or less. This extrapolation occurs over the terminal part of the SDR response bounded by values of SAL of  $10^{-2}$  and  $10^{-6}$  and clearly, in the present context, it is this terminal part that is the functional part of the SDR response. As can be seen from Figure 3, the average resistance of the terminal SDR response for each of the population sizes is delineated by a straight line (solid line) passing through the two points having coordinates,  $(\log 10^{-2}, \text{VD kGy})$  and  $(\log 10^{-6}, \text{SD [sterilization dose] kGy})$ . Each such average resistance, unique to the population size, is expressed as a terminal  $D_{10}$  value that, for purposes of identification, is given the symbol  $TD_{10}$ . For each of a number of population sizes extending over the range 1 to 1000 characteristic of Method TR, the value of  $TD_{10}$  has been compared with that of  $D_{lin}$  to establish which represents the greater radiation resistance and would thus be the more conservative for use in making the predictive link. Figure 3 allows a visual comparison to be made of the responses defined by the two values for each of the limiting population sizes of 1 and 1000.

It is obvious from Table 4 that the relationship between values of  $TD_{10}$  and  $D_{lin}$  changes with changing population size; for sizes in the range 1 up to 50, values of  $TD_{10}$  are less than corresponding values of  $D_{lin}$ , whereas, for sizes above 50 and up to 1000,  $TD_{10}$  values are greater than those of  $D_{lin}$ . Thus, for the lower domain of population sizes, the response defined by  $D_{lin}$  is more conservative, and for the upper domain, it is the response defined by  $TD_{10}$  which is the more conservative.

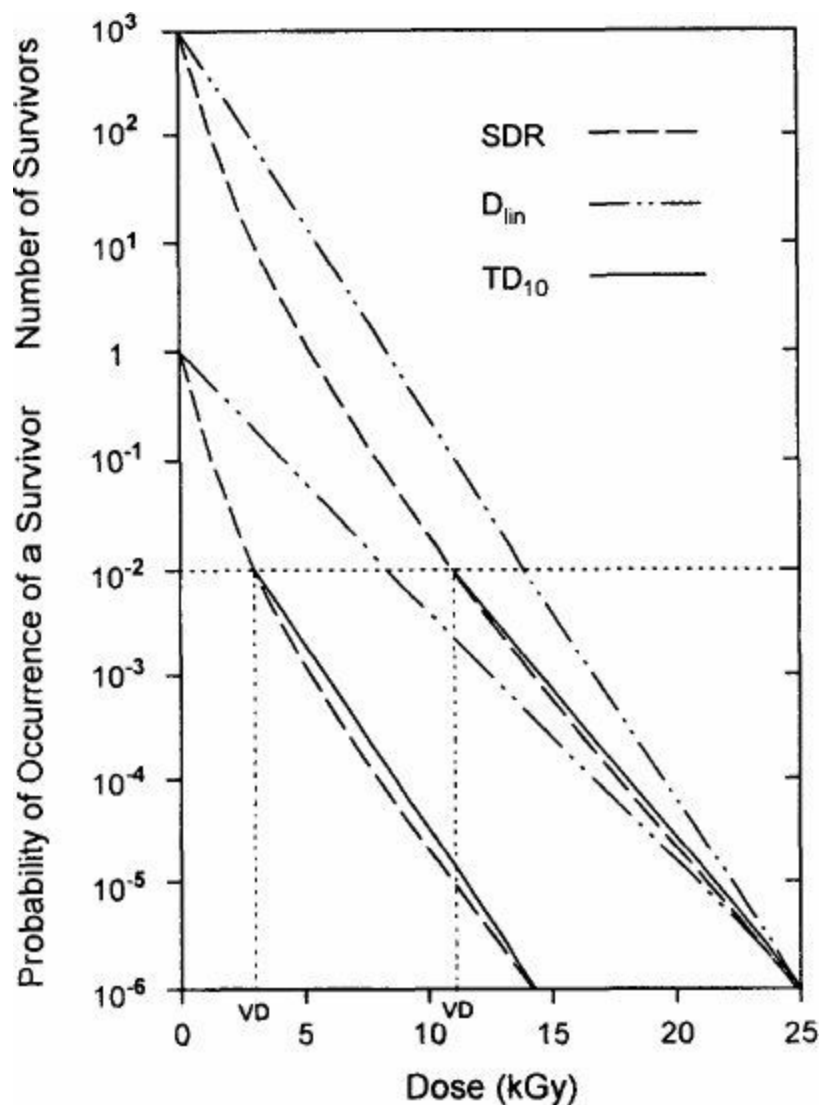

**Figure 3.** Responses defined by  $D_{lin}$  and  $TD_{10}$  for each of the population sizes of 1 and 1000.

**Table 4.**  $TD_{10}$  Values (kGy) Derived from SDR Responses and  $D_{lin}$  Values (kGy) Derived From Linear Inactivation Curves for Various Population Sizes

Population Size	$TD_{10}$	$D_{lin}$
1000	3.47	2.78
500	3.43	2.87
100	3.31	3.13
50	3.25	3.25
10	3.10	3.57
5	3.02	3.73
1	2.81	4.17

Using values of  $D_{lin}$  and  $TD_{10}$  we established, in a rational manner, a predictive link between the outcome of the verification experiment and substantiation of 25 kGy that

possesses a level of conservativeness at least equivalent to that built into the SDR. Simple equations have been developed to yield values of verification doses, defined by either  $D_{lin}$  or  $TD_{10}$ , as appropriate. These doses, each peculiar to the population size and the verification SAL, are in effect determined by the maximal allowable resistances of microorganisms surviving the verification SAL to provide exactly an SAL of  $10^{-6}$  at 25 kGy, such resistances taking into account the conservatism of the SDR. The designate given to such a dose is the maximal verification dose, symbolized by  $VD_{max}$ . It is through the values of  $VD_{max}$  that a substantive predictive link is made.

Here it is recognized that the above concepts have been developed using a single verification SAL of  $10^{-2}$  and a range of population sizes equivalent to that of the bioburden levels adopted in Method TR. However, the same underlying principles can be used to derive values of  $VD_{max}$  for other values of verification SAL, falling say between  $10^{-2}$  and  $10^{-1}$  as applies for Method TR. When this is effected,  $VD_{max}$  values are obtained that are consistently higher than corresponding Method TR verification doses. An exception occurs at a population size of 1000 where the two doses are equal (this is inevitable as a population of 1000 microorganisms comprising the SDR effectively attains an SAL of  $10^{-6}$  at 25 kGy). One expected benefit from using higher doses for verification is a substantial reduction in the occurrence of 'incorrect' outcomes without compromising the safety of the substantiation activity.

Recently, we have expressed the view that the principles outlined above, and elaborated more fully elsewhere [8], could form the basis for development of an improved method for substantiation of 25 kGy, procedurally similar to Method TR but of much sounder design. The method would possess the conservatism inherent in Method 1; its design would be such that the method would have a direct link between the outcome of the verification experiment and achievement of an SAL of  $10^{-6}$  at 25 kGy; passing the verification experiment would demonstrate the appropriateness of sterilization at 25 kGy, whereas failure would denote the inadequacy of this radiation dose — in other words, the method would have an unambiguous pass/fail outcome.

# Conclusion

Revision of ISO documents describing the various dose setting/substantiation methods is to occur within the next 2 years. These methods are crucial to the process of compliance with the requirements for selection of a sterilization dose specified in the International and European standards for validation and routine control of radiation sterilization processing. A reappraisal of the dose setting/substantiation Method 1, and of its adaptation described in ISO/TR 13409, has shown that:

- a) Method 1 is generally a reliable and safe method of dose setting or substantiation. The method is able to select from microbial populations, differing from the Standard Distribution of Resistances to varying degrees, those populations for which a sterilization dose can be established, although it tends to be less discriminating with populations small in size. In view of the latter, it is proposed that a lower limit be placed on the bioburden level of product for which Method 1 can be used.
- b) When applied within the limits placed on sample size and bioburden level, the method for substantiation of 25 kGy given in ISO/TR 13409 is safe. However, the method can frequently fail to discriminate between microbial populations that can or cannot be sterilized by exposure to a dose of 25 kGy, although, in this regard, it always errs on the side of safety. This inability is attributed to a design fault in the method. As currently described, the method is not considered to be appropriate for substantiation of 25 kGy as a sterilization dose.

There is merit in developing a method for substantiation of 25 kGy which is an adaptation of Method 1. However, such a method has to have a substantive link between the outcome of the verification experiment and attainment of sterility at 25 kGy. A basis for a link of this type has been described [8]. With development, the link could form part of an improved method of dose substantiation that would provide an unambiguous pass/fail outcome. The aim should be to devise a method which is applicable to all products intended to be sterilized by exposure to a sterilization dose of 25 kGy.



# Acknowledgments

The author is indebted to Dr. Yan Aoshuang of Beijing Radiation Application Research Centre, Beijing 100012, P. R. China and to Dr. John Kowalski of Johnson & Johnson, Sterilization Science & Technology, New Brunswick, NJ 08906-6594, U.S.A. for data generated during collaborations with him and for many hours of valuable and enjoyable discussions.

# References

1. AAMI Recommended Practice. Process Control Guidelines for Gamma Radiation Sterilization of Medical Devices. Arlington: Association for Advancement of Medical Instrumentation; 1984.
2. ANSI/AAMI Standard 32-1991. Guideline for Gamma Radiation Sterilization. Arlington: Association for Advancement of Medical Instrumentation; 1992.
3. Davis KW, Strawderman WE, Masefield J, Whitby JL. DS Gamma radiation dose setting and auditing strategies for sterilizing medical devices. In: Gaughran ERL, Morrissey RF, editors. Sterilization of Medical Products. Montreal: Multiscience Publications; 1981. p. 34-102.
4. Davis KW, Strawderman WE, Whitby JL. The rationale and computer evaluation of a gamma sterilization dose determination method for medical devices using a substerilization dose test protocol. *J Appl Bacteriol* 1984;57;31-50.
5. European Standard EN 552: 1994. Sterilization of Medical Devices — Validation and Routine Control of Sterilization by Irradiation. Brussels: European Committee for Standardization; 1994.
6. International Standard ISO 11137: 1995. Sterilization of Health Care Products — Requirements for Validation and Routine Control — Radiation Sterilization. Geneva: International Organization for Standardization; 1995.
7. ISO Technical Report ISO/TR 13409: 1996. Sterilization of Health Care Products — Substantiation of 25 kGy as a Sterilization Dose for Small or Infrequent Production Batches. Geneva: International Organization for Standardization; 1996.
8. Kowalski JB, Tallentire A. Substantiation of 25 kGy as a sterilization dose: a rational approach to establishing verification dose. *Radiat Phys Chem*. In press 1998.
9. Takehisha M, Shintani H, Sekiguchi M, et al. The radiation resistance of the bioburden from medical devices. *Radiat Phys Chem*. In press 1998.
10. Van Asten JAAM. The reliability of dose setting systems. *Radiat Phys Chem* 1990;35;361-3.
11. Whitby JL. Radiation resistance of microorganisms comprising the bioburden of operating room packs. *Radiat Phys Chem* 1979;14;285-8.
12. Whitby JL, Gelda AK. Use of incremental doses of cobalt 60 radiation as a means to determine radiation sterilization dose. *J Parent Drug Assoc* 1979;33;144-55.
13. Whitby JL. Comments on the Japanese study of the radiation resistance of the bioburden of medical devices. *Radiat Phys Chem*. In press 1998.
14. Yan A, Tallentire A. Distribution of radiation resistances of microbiological contaminants of a cotton-based medical product. *Radiat Phys Chem* 1995;46; 591-5.

---

1. It should be noted that, for the present theoretical work, the acceptance criteria for verification does not consider the number of positives generated in tests of sterility that might form part of a practical verification dose experiment.



# Viral Safety of Biological Products<sup>1</sup>

Thomas J. Lynch, Ph.D.

*Center for Biologics Evaluation and Research, Food and Drug Administration, U.S.A.*

It is perhaps appropriate to note that the comprehensive regulation of therapeutic products in the United States began with biologics [20,32]. In 1902, the Virus, Serum, and Antitoxin Act (often referred to simply as the Biologics Act) was enacted, four years before the Pure Food and Drugs Act, the forerunner of the Federal Food, Drug, and Cosmetic Act. The impetus for the Biologics Act were several tragic incidents. In 1901 and 1902, batches of smallpox vaccine and diphtheria anti-toxin were contaminated with tetanus; the use of these products resulted in serious illness and a number of deaths. The Biologics Act was reenacted in 1944 as part of the Public Health Service Act where it resides today (42 U.S.C. 262).

Prior to 1972, when the Food and Drug Administration (FDA) assumed its current responsibilities, biologics were regulated by various components of the National Institutes of Health. In an effort to emphasize the regulatory mission over the traditional research endeavors of the National Institutes of Health, the Division of Biologics Standards was formed in 1955. This reorganization was at least partially motivated by the 'Cutter incident' in which polio was transmitted by several lots of polio vaccine that had not been completely inactivated. In 1983, the human immunodeficiency virus (HIV) was recognized as a transmissible agent that threatened the safety of the blood supply and products made from human plasma. This experience led to enhanced safeguards against the transmission of disease by blood and blood products.

Even from this brief history, it is apparent that the risk of transmitting disease has played a pivotal role in defining the regulation of biologics. Intuition tells us that this is a logical consequence of the nature of biologics. After all, biologics are derived from natural sources (man, animals, plants, and microbes), in many cases are only partially purified, heterogenous mixtures of biochemicals, and are usually complex molecules (or worse) that defy characterization with the same degree of precision as that expected for more traditional pharmaceuticals.

The formal definition of a 'biological product' is a "virus, therapeutic serum, toxin, anti-toxin, vaccine, blood, blood component or derivative, allergenic product, or analogous product...applicable to the prevention, treatment or cure of a disease or condition of human beings." [35] This definition has probably engendered more debate than certainty, but the list (along with arsphenamine, its derivatives, and other trivalent organic arsenic compounds) comprises the current meaning of a biologic in the Public Health Service Act. Moreover, many products that intuition might suggest are biologics (insulin, antibiotics, hormones), are in fact regulated as drugs.

Nevertheless, the range of products regulated as biologics is incredibly broad. Blood, blood components and derivatives, vaccines, allergenics, and anti-toxins are all specifically mentioned in the above definition, and all are represented by currently-licensed products. The terms 'therapeutic serum' and 'analogous product' have been interpreted broadly to encompass products of biotechnology, monoclonal antibodies, cells, tissues, and gene therapies. Hence, the diversity of biologics complicates a discussion of any single subject, such as sterility, that touches all of them.

To simplify this task, the scope of this article has been limited in two significant (and wholly arbitrary) ways. The focus will be on therapeutics derived from biological sources, without regard to their formal classifications as drugs or biologics. It is the source from which a product is derived that in many ways determines the risk associated with that product. This allows the subject to be treated in general terms in an effort to identify broad principles applicable to the viral safety of many types of biologics. Second, there will be a concentration on the risks associated with the transmission of viruses as opposed to other microbial contaminants [21,38]. Since most biologics are not amenable to terminal sterilization techniques, their sterility depends for the most part on controlling bioburden during manufacturing, sterile filtration, and subsequent aseptic processing. These procedures are well established, have been the subject of numerous reviews in the literature, and need not be revisited here. On the other hand, viruses are not removed or inactivated sufficiently by these techniques, and so other safeguards must be implemented.

# Thinking About Safety

There are three perspectives from which risk of transmitting disease by biologics may be addressed and from which those risks may be reduced (Figure 1). First, if a product is derived from a living organism, the product is theoretically susceptible of contamination by any pathogen that can infect that organism. This risk can be addressed by screening the source material for the presence of infectious agents known to pose a risk to the human recipients of the product. Second, if the manufacture of the product includes extensive processing, there is an opportunity to remove a potential pathogen from the source material so that it does not contaminate the final product. If, however, the product must be administered in a substantially unaltered state (transfusable blood components would be an example) the opportunities for eliminating a contaminating pathogen are limited. Finally, in the event that a contaminated product is distributed, reporting of adverse events associated with the use of that product (or active surveillance mechanisms where they exist) can provide early warning of the problem and allow for the removal of the product from the market soon enough to mitigate the risk to patients. The product itself, as well as the procedures for its manufacture, would also be scrutinized with the objective of identifying and correcting any deficiencies in production methods and/or source material.

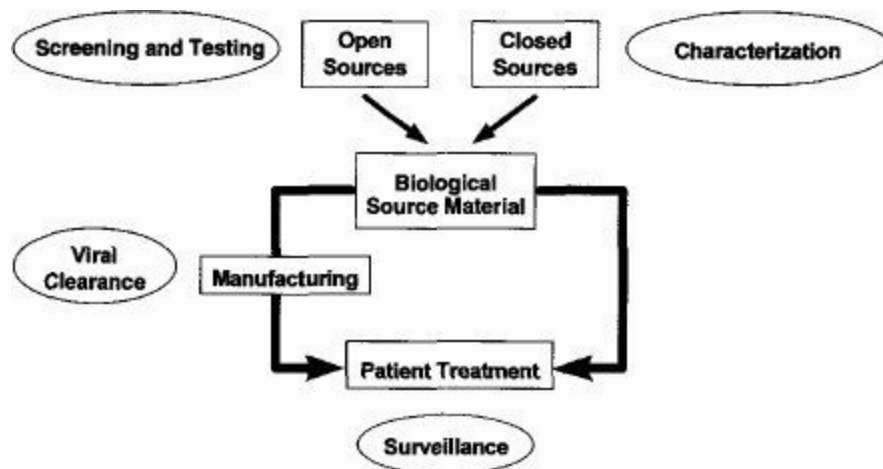

**Figure 1.** The production and use of biological products affords three main opportunities for intervention in order to minimize the risk of transmitting viral diseases. First, the possibility of viral contamination of the source material(s) can be minimized by screening and testing where products are derived from open sources, or by fully characterizing a closed source such as a cell line for the presence of potentially infectious agents. Second, for products that undergo extensive manufacturing such as purified proteins, viral clearance procedures may be incorporated into the production processes. Finally, by monitoring the use of the products, unexpected adverse events including transmission of infectious agents may be detected and appropriate safety measures implemented.

# Defining Risk

## *Type of Contaminant*

Viral contamination of a source material may be the result of an infection in one or more donors contributing that source material. The most familiar examples are human viruses that may contaminate blood or plasma donations, such as hepatitis B (HBV), hepatitis C (HCV), or HIV, which may be transmitted to recipients of transfusable components or products derived from the donation(s) [34]. This risk may be mitigated in the case of a virus that is not usually found during an active infection in the tissue or body fluid that comprises the source material [33]. Alternatively, the genomes of some cells may contain integrated sequences of retroviruses which could pose a risk if those cells (or the tissue or organ containing them) were the biologic product itself [23]. The risk of endogenous retroviruses should be small in the case of acellular products or where the manufacturing of cellular source material into a final product removes substantially all of the genetic material.

A third type of contamination is the introduction of an adventitious infectious agent during the course of manufacturing. Since this type of contamination should be minimized by the proper handling of source material and by standard safeguards during manufacturing, this possibility will not be considered further.

## *Nature of Contaminant*

The inherent risk of any particular virus depends on the clinical consequences of an infection with that virus. But risk is also dependent on the likelihood of a particular virus infecting a human; viruses known to be capable of infecting humans naturally pose the greatest risks. It follows that source materials derived from human donors pose the greatest risks since any virus that infects a human donor is a potential human pathogen. At the other extreme are source materials derived from organisms at great phylogenetic distances from humans, such as bacteria and yeast. Here the risk to humans of, for example, a bacteriophage should be minimal.

In between these extremes are source materials derived from animals or animal cells. Clearly some animal viruses are capable of infecting humans (i.e., are zoonotic) [1,40] and in these cases it seems immaterial whether these viruses are derived from human or nonhuman source material. On the other hand, many animal viruses are known or thought not to be capable of infecting humans and so should pose a lower immediate risk to humans exposed to them. However, it is possible that continued exposure of humans to a noninfectious virus could increase the chance of a zoonotic variant of the virus emerging in the human population [28]. Although it is not possible to quantify such a risk, the concern is nonetheless legitimate and the potential contamination of biologics with nonzoonotic viruses should be avoided whenever possible.

The potential risk of emergent viruses creates a difficult problem of designing precautionary measures [6,24]. Since it is not possible to predict the properties of a virus (or any other infectious agent) that does not currently infect humans, but which may do so in the future, it is not possible to screen source material for the presence of such a virus or to

be assured that manufacturing methods are capable of removing or inactivating it. Certainly a requirement that a donor, whether human or animal, be in generally good health does mitigate the risk that the donor is harboring a hitherto unrecognized infectious agent. However, pathogens with long latency periods have gone unrecognized until after their transmission to others via biologics manufactured from source material derived from infected but asymptomatic donors.

### *Nature of Source*

The risk inherent in any source material is difficult to calculate with precision since it is the product of both known and unknown risks. In the case of source material collected from donors who exist free in the environment and whose activities are uncontrolled, this uncertainty is at its greatest. Such sources will be termed 'open sources' since the individuals are susceptible to new infections by known and emergent agents. In contrast, some biologics are derived from 'closed sources' such as cell cultures that are minimally exposed to environmental contaminants and the potential for new infections. In principle, the isolation of such sources should also minimize the risk of newly emergent infectious agents.



# Reducing Risk: Source Material

The first opportunity to reduce the risk of transmitting viruses by biologics is by minimizing the chance that the source material is contaminated with viruses. Two different strategies have been adopted, depending on whether the source material for the product is derived from ‘open sources’ or ‘closed sources’.

## *Screening and Testing*

When biologics are manufactured from ‘open sources’, it is impossible to be certain *a priori* that the source material is free of contaminating viruses. Therefore, testing of the source material becomes an important safeguard. The most elaborate example of this is the screening and testing of blood and plasma units derived from human donors [19].

Before blood is donated, the donor is screened by medical exam and history, and by means of specific questions intended to identify behaviors that would place the donor at high risk for certain viral infections. If the results of this initial screening are unsatisfactory, a donation is not made and the donor is deferred—that is, the donor is asked not to attempt to donate in the future. If screening reveals no undue risks, the donor contributes a unit of blood or plasma, which is then quarantined. The donated unit is subjected to a battery of tests for a number of viruses (see Table 1) and if those tests are negative, the unit is released for transfusion or further manufacturing.

**Table 1. Viral Testing of Human Blood and Plasma<sup>a</sup>**

<i>Screening Assay</i>	<i>Blood for Transfusion</i>	<i>Plasma for Fractionation</i>
HBsAg (hepatitis B surface antigen)	Required	Required
anti-HBc (hepatitis B core antibody)	Recommended	Recommended
anti-HCV	Recommended	Recommended
anti-HIV 1 & 2	Required	Required
p24 (HIV antigen)	Recommended	Recommended
anti-HTLV-I & -II	Recommended	Not recommended
ALT (alanine aminotransferase)	Not recommended	Not recommended

<sup>a</sup> ‘Required’ indicates a particular test is specified in Title 21 of the Code of Federal Regulations. ‘Recommended’ indicates that FDA has recommended performing the test in various memoranda to blood and plasma establishments. Recommended tests are universally performed.

Viral testing includes direct assays for viral antigens (HBV surface antigen [HBsAg] and the p24 antigen of HIV) as well as assays for antibodies against viruses that evidence past infections. It is important to recognize a limitation to these tests: it takes a certain amount of time after an individual is infected with a virus before the relevant test would produce a positive result (Figure 2). This period is known as the ‘window’, the length of which is characteristic for each specific virus. The length of the window period also depends on the

type and sensitivity of the test performed. For example, the tests for anti-HIV antibodies have a window period of about 22 days post-infection whereas the p24 antigen test has a window of about 11 days. A donation collected during the window period would test negative but could potentially transmit the virus with which the donor was infected. Of course, the longer the window period, the greater is the chance that any individual donation is a window donation. Because much of the risk associated with blood donations is due to window donations, reducing the length of the window periods has become a major focus for improving the safety of human blood and plasma.

A second approach to minimizing the risk of window donations is termed 'look-back'. When a donation tests positive, prior donations that tested negative but which could have been window donations are identified and, if they have not already been used, are retrieved and destroyed. Recently, commercial plasma collection centers have increased the period of time during which negative units are held prior to further manufacturing in order to improve the effectiveness of lookback in retrieving potential window donations.

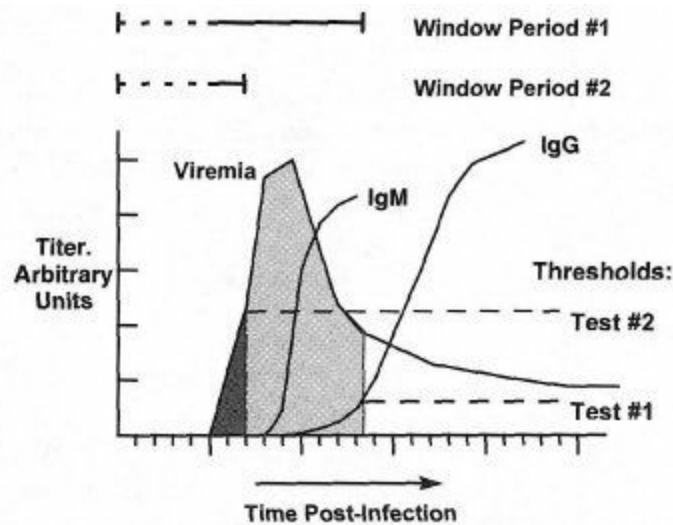

**Figure 2.** Hypothetical time course of viremia and the immune response of an individual donor infected with a virus. The application of two different types of tests are illustrated. Test #1 is an assay that detects IgG produced by the individual in response to the infection, whereas Test #2 is an assay for a viral component (either an antigen or nucleic acid). Because viremia precedes the host response by some time, Test #2 detects the infection sooner and consequently has a shorter window period associated with it. Note also that immediately after an infection, before significant replication of the virus, infectivity of the source material contributed by the donor may be low.

### Full Characterization

An alternative approach to continuous testing of source material is possible when 'closed sources' are utilized. The best examples of this are products of biotechnology that are derived from cell cultures, such as recombinant proteins and monoclonal antibodies. These products are derived from large cultures (the 'production cells') usually maintained in

bioreactors. In many cases, mammalian cell lines are used as production cells, which raises the viral safety issues discussed above.

Because the production cells cannot be cultivated indefinitely, the cultures must be periodically restarted. However, these new cultures do not represent entirely new source material; rather each culture shares a common origin through a system known as cell banking [4,18]. When a cell line is developed to produce a particular product (e.g., by stable transfection), many aliquots of a single, homogeneous culture are frozen and stored as a master cell bank. One or more aliquots of the master cell bank are then expanded and aliquots of the resultant culture are frozen away as a working cell bank. Each aliquot of the working cell bank can be expanded to a production cell culture when needed. Each master cell bank can give rise to many working cell banks, each of which can be the source of many production cell cultures.

Because the production cells are derived from a common source, and because the cell banks and production cells are maintained under controlled conditions, it is possible to define the risks associated with the source material with some precision and certainty. The master cell bank is extensively studied for the presence of viruses and virus-like particles by a combination of analytical methods that are capable of detecting both expected and unexpected contaminants. The production cells at the end of their useful culture period (end of production cells) are also examined for the presence of viruses (primarily retroviruses) that may have emerged during cultivation. Once it is established that the production cells and cell banks are free of a particular virus, there is no necessity to continuously screen the source material for that virus.

# Reducing Risk: Viral Clearance During Manufacturing

Despite the precautions described above, the potential risk of contaminating viruses cannot be entirely eliminated from any biological source material. In cases where the source material is the product (e.g., transfusable blood components), reducing the residual risk that remains after screening and testing currently represents the most effective strategy for improving the viral safety of these products. However, for those products which result from extensive processing of source materials, additional safeguards in the form of specific viral clearance steps can be built into the manufacturing processes. Although viral clearance is applied to the manufacturing of a wide variety of products, including biotechnology products, the manufacturing of plasma derivatives will be used as the primary example here [8,13,14,36].

## Clearance Methods

Clearance can be effected by methods that inactivate or remove viruses (see Table 2). Many manufacturing processes incorporate steps relying on both mechanisms, the overall safety of these products resulting from their combined effects.

Viral inactivation traces back to the 1940s when the heat-treatment of albumin was adopted [11]. Since then, a number of other methods of inactivating viruses have been applied to the manufacture of plasma derivatives. In response to the realization that HIV could be transmitted by the use of plasma-derived coagulation factors, various heating protocols were developed and applied to these products in the mid-1980s. Subsequently, a chemical method was developed by which a process intermediate is treated with a combination of an organic solvent (tri-N-butyl phosphate) and any of several nonionic detergents [17]. The 'solvent/detergent' method proved extremely effective against viruses such as HIV that possessed a lipid envelope, but had little effect on nonenveloped viruses.

**Table 2. Viral Clearance Methods**

		<i>Viral Inactivation Methods</i>
Physical Methods	Heat	Heating in solution (final containers or bulk)
		Dry heating in final containers (lyophilized products)
		Vapor heating (elevated pressure and controlled humidity)
	Ionizing	
	Radiation	Ultraviolet (with or without photoactivatable compounds)
		Visible (with photoactivatable compounds)
Chemical Agents	Nucleic acid targets	Alkylating agents
	Membrane lipid	Solvent/detergent
		Acidic pH (with or without protease)

targets	Sodium thiocyanate
Others	Iodophors

---

*Virus Removal Methods*

---

Specific Methods	Nanofiltration	Various porosities, materials, and configurations
Purification Steps	Partitioning	Precipitation methods (ethanol fractionation, PEG, cryoprecipitation)
	Chromatography	Affinity and ion exchange

---

The successful application of a viral inactivation method requires not only that the method be effective against the viruses of concern, but that the biological activity, structural integrity, and nonimmunogenicity of the product be preserved. (Compare this to the production of inactivated vaccines, where the preservation of immunogenicity and the destruction of biological activity are the objectives.) For instance, as the extent of heat-treatment is increased (by increasing either time or temperature), the extent of viral inactivation increases, but so does the likelihood of denaturing the product. For this reason, viral inactivation steps must be designed to optimize both viral inactivation and product recovery. This can be achieved by adding stabilizing agents to the product and/or by limiting the extent of the treatment.

Viruses can also be removed during the manufacturing of many products by virtue of the fact that most manufacturing processes entail extensive purification of the product from the source material [3,27]. As other contaminants are removed via purification, some viruses may be removed as well. In addition, some routine processing steps (e.g., ethanol precipitation of plasma derivatives or the lyophilization of dried products) may also inactivate viruses to some extent. In all of these cases, the primary purpose of the manufacturing step has to do with the preparation of the product itself and the removal of viruses is a fortuitous side-benefit. Recently, however, specific filtration methods have been developed to remove viruses. Termed 'nanofiltration', these techniques rely on the use of small pore-size filters ( $\leq 100$  nm) through which the product passes but which retains viruses larger than the effective pore-size [12,30]. These filters have proven quite effective, but their utility may be limited in cases of extremely small viruses or extremely high molecular weight products.

### *Validation of Viral Clearance*

A detailed discussion of this area is well beyond the scope of this article, but because of the central importance of validation studies in assuring the viral safety of biological products, some general remarks are in order. Validation studies measure the effectiveness of a viral clearance method, define the range of operating parameters within which the clearance process must be held in order for the process to be effective, and provide assurances that the viral clearance step can be controlled such that its effectiveness during routine operations is assured [5,7,19]. There are three distinct phases to achieving these

goals.

First, a laboratory model of a manufacturing process step is established. While this may seem to contradict the conventional approach to process validation, it is necessary because it is undesirable to introduce live viruses into production facilities, and because it is not possible to prepare sufficient amounts of viruses to validate clearance at full-scale. However, it is essential to show that the laboratory model is in fact an accurate model of the production process, which entails a separate series of studies to demonstrate equivalent performance.

Second, the effectiveness of the step is assessed by means of spiking studies in which an upstream intermediate is spiked with a large amount of virus, the laboratory scale process step is performed, and residual virus present in the product of that step is measured by any of several viral titration methods. Several such studies are typically performed that incorporate viruses that may actually be found in the source material (relevant viruses) and viruses that resemble relevant viruses where the latter are not amenable to laboratory manipulation. The result of these studies are reduction factors (expressed as  $\log_{10}$ ) achieved by the process step for each virus tested. It is not uncommon for a single step to be effective against one virus (or type of virus) but not another, so multiple steps within a single manufacturing process are often validated for viral clearance. The cumulative effect of multiple steps in clearing a particular virus may also be considered, if the steps operate by distinct chemical and/or physical mechanisms.

Finally, once the effectiveness of a particular viral clearance step has been demonstrated, its continued effectiveness during routine manufacturing operations must be assured by conventional process validation. The critical operating and control parameters necessary to assure that the viral clearance step achieves the expected level of effectiveness should have been identified during the laboratory studies. Permissible ranges for these parameters should also have been defined. Once this information is in hand, the clearance step is validated at the full manufacturing scale by demonstrating that the critical parameters are under control and that the clearance step will perform consistently and reliably.

Once a viral clearance step has been properly validated, its reliability on a day-to-day basis must be assured by the application of Good Manufacturing Practices [29]. Written procedures should be detailed and unambiguous and the manufacturing record should, at a minimum, document that the critical control parameters were maintained within predefined limits and that all operating parameters were attained for that batch. Equipment should be properly maintained and instruments used to control and/or monitor the process routinely calibrated. Deviations from established procedures should be completely investigated and evaluated. The acceptable performance of the viral clearance step should be completely documented in the manufacturing records for each batch of product.

# Reducing Risk: Surveillance and Adverse Event Reporting

Collecting and assessing information regarding adverse events associated with the use of a biologic product serves at least two functions. First, it may be the only way to identify that a defect is associated with a particular lot of a product. That lot may then be withdrawn from the market, limiting the number of patients exposed to the implicated product. Second, unexpected adverse events associated with a product may indicate that a previously unrecognized risk exists. In this case, additional warnings in the product's labeling, additional precautionary measures when using the product, or the curtailed use of the product may all be appropriate responses.

When the adverse events involve the transmission of a viral infection, it is particularly important that the information be reported and investigated promptly, and that appropriate action is taken. This goal is confounded somewhat by the fact that often the infection is coincident with the use of a biologic and not caused by it. Moreover, where a product is implicated in the transmission of a disease, there may be several possible underlying causes.

For instance, in 1976, an albumin product that had been heat-treated in the conventional way transmitted hepatitis B to several recipients [31]. By then, the heat-treatment of albumin (60°C for 10 to 11 hours) was considered completely effective in eliminating the risk of hepatitis B. For most products, heating was performed in the final containers of albumin, but in this case, a bulk solution had been heated in a tank prior to filling the final containers. Investigation revealed a 'cold spot' in this tank which permitted part of the solution to escape the full effect of the heat-treatment. In today's parlance, this situation would have been characterized as a failure to properly qualify the tank for its intended use by not performing temperature mapping studies. Today, all albumin products are heat-treated in their final containers, but other products may be heated according to the same regimen as bulk solutions.

Another incident involved the unexpected transmission of hepatitis C by an intravenous immunoglobulin product in 1993 [2]. Because of a long record of use of both intramuscular and intravenous immunoglobulins without transmitting HCV (or non-A, non-B hepatitis), these products had been considered safe in this regard. However, an improvement in the method for testing blood and plasma donations for anti-HCV antibodies had been introduced just prior to these transmissions. Apparently, implementation of the new test reduced the amounts of anti-HCV antibodies present in the plasma pools from which the product was made, which changed the way the virus partitioned during manufacturing and led to contamination of the product [33]. Today, the manufacturing processes for all intravenous immunoglobulins include validated viral clearance steps.

Perhaps the most dramatic and tragic example of the use of information regarding the adverse consequences of the use of products was the emergence of HIV in the blood supply and in coagulation factors manufactured from human plasma [25]. In 1982, the initial cases of Acquired Immunodeficiency Syndrome (AIDS) were reported in two hemophiliacs, suggesting that the condition might be transmitted by an infectious agent present in the coagulation factors they used. Although interim precautionary measures were undertaken, it

was not until 1984 that viral inactivation steps were incorporated into the manufacturing of most coagulation factors and 1985 that testing of blood and plasma donations for anti-HIV antibodies could be implemented. Among the many lessons to be learned from this experience is the fact that an adequate response to a newly identified risk may take considerable time to formulate and implement. Furthermore, by the time a new risk is recognized, considerable harm may have already occurred—this was certainly the case during the early phases of the AIDS epidemic because of the long, asymptomatic latency period that usually follows infection with HIV.

Since the 1980s, there have been considerable improvements in the reporting of adverse events and several surveillance programs that focus on discrete patient groups have been established. The ability of the responsible public health authorities, such as FDA and the Center for Disease Control and Prevention, to investigate and respond to adverse information has also improved. For instance, additional testing of final products (by a sensitive PCR test for HCV RNA) was instituted as an interim safety measure within months of the initial reports of transmission of HCV by intravenous immunoglobulin. While surveillance and the reporting of adverse events will remain a critical part of the safety net for biologics, it is obviously preferable to preclude the occurrence of adverse events by anticipating and preventing foreseeable risks.



# Looking Ahead

The safety of biologics particularly with respect to the risks of transmitting viruses is not so much a goal as it is an ongoing process. Although biological products today enjoy excellent safety profiles, efforts continue in a variety of ways to improve margins of safety. Three of the significant areas in which viral safety can be enhanced are considered here.

Testing of source material can only reveal the presence of infectious agents for which testing is performed. However, source materials are not usually tested for every conceivable agent for which testing is technologically possible. This is particularly true for open sources, such as human blood or plasma, where unrestricted testing would be physically impractical and prohibitively expensive. Instead, infectious agents are selected for testing based on the risk they may contaminate a particular source material and the clinical significance of infection to the patient. Of the known agents for which testing is performed, considerable efforts are being made to increase the effectiveness of this testing. The principal strategy is to reduce the window period, discussed above, by devising tests that detect an infected donor sooner after infection occurs. This can be accomplished by increasing the sensitivity of a particular type of test or by testing for a different marker that appears earlier in the course of an infection (e.g., a viral antigen or nucleic acid instead of an antibody produced by the infected individual). Another strategy is to delay the use of a source material until there has been an opportunity for a subsequent test of the donor. The longer the delay between the donation and a subsequent negative test, the less likely it is that the donor was in the window period when the original donation was made.

Viral clearance methods are also being constantly improved. Efforts are underway to better understand and control production processes in order to provide greater assurance that viral clearance methods are reliably executed. Measures to increase the viral reduction factors associated with particular manufacturing processes are also common—most often involving the addition of multiple viral clearance steps within a single process. New methods of inactivating viruses are also being developed, especially with the goal of expanding the range of virus types that can be effectively eliminated. For example, many existing viral clearance methods are more effective against lipid-enveloped viruses than against nonenveloped viruses. For blood products, the enveloped viruses are of greatest clinical importance today, but improving our ability to eliminate nonenveloped viruses would not only address concerns related to those viruses which are presently known, but would reduce the health consequences should a new, virulent, nonenveloped virus emerge in the blood supply in the future.

Finally, viral clearance methods will almost certainly be adopted to a broader range of products in the future. Currently, viral clearance is accomplished as part of production processes in which large amounts of source material(s) are combined and manufactured into final product. For plasma derivatives, this entails the pooling together of many thousands of individual plasma units, which amplifies the risk that any one pool contains at least one potentially infectious unit [26]. However, most blood components are not pooled prior to transfusion, at least not to such a large extent, nor are they subjected to extensive manufacturing activities. The risk of viral contamination of any single unit that results from

the inherent limitations of screening and testing, while less than that of a pool of thousands of such units, is still finite. There are two ways of applying the additional safeguard of viral clearance methods to these products. One could pool together many units that would ordinarily be transfused individually or in small numbers, treat the pool with a viral inactivation or removal technique, and then redistribute the pool into individual units. This strategy has been adapted for human plasma in order to treat it with a solvent/detergent [16]. Alternatively, one could apply a viral clearance method on a unit-by-unit basis and avoid the risk attendant to pooling. This approach is exemplified by methylene blue-treated human plasma available in some European countries [22]. To expand the application of viral clearance to a wider array of blood components such as red cells, a number of irradiation techniques, with or without the inclusion of photoactive compounds, are under development [9,10,15]. It is hoped that these and perhaps other methods will be found useful for cell-based therapeutics, tissues, and the next generation of biologics.

# References

1. Brack M. Agents Transmissible to Man, Berlin: Springer-Verlag, 1987. Allan JS. Primates and new viruses. *Science* 1994;265:1345-46.
2. Bresee JS, Mast EE, Coleman PJ, et al. Hepatitis C virus infection associated with administration of intravenous immune globulin: A cohort study. *JAMA* 1996;276: 1563-67.
3. Burnouf T. Chromatographic removal of viruses from plasma derivatives. *Dev Biol Stand* 1993;81:199-209.
4. Center for Biologics Evaluation and Research. Points to consider in the characterization of cell lines used to produce biologicals. 1993.
5. Center for Biologics Evaluation and Research. Points to consider in the manufacture and testing of monoclonal antibody products for human use. 1997.
6. Chamberland M, Khabbaz R. Emerging issues in blood safety. *Inf Dis Clin North Am* 1998;12:217-25.
7. Committee for Proprietary Medicinal Products. Note for guidance on virus validation studies: The design, contribution and interpretation of studies validating the inactivation and removal of viruses. CPMP/268/95, September, 1996.
8. Cuthbertson B, Reid KG, Foster PR. Viral contamination of human plasma and procedures for preventing virus transmission by plasma products. In: Harris JR, editor. *Blood Separation and Plasma Fractionation*. New York: Wiley-Liss; 1991. p. 385-435.
9. Dodd RY. Viral inactivation in platelet concentrates. *Transfus Clin Biol* 1994;1:181-6.
10. Friedman LI, Stromberg RR. Viral inactivation and reduction in cellular blood products. *Rev Fr Transfus Hemobiol* 1993;36:83-91.
11. Gellis SS, Neefe JR, Stokes J Jr, Strong LE, Janeway CA, Scatchard G. Inactivation of the virus of homologous serum hepatitis in solutions of normal human serum albumin by means of heat. *J Clin Invest* 1948;27:239-44.
12. Hamamoto Y, Harada S, Kobayashi S, et al. A novel method for removal of human immunodeficiency virus: filtration with porous polymeric membranes. *Vox Sang* 1989;56:230-6.
13. Horowitz B. Specific inactivation of viruses which can potentially contaminate blood products. *Dev Biol Stand* 1991;75:43-52.
14. Horowitz B, Ben-Hur E. Strategies for viral inactivation. *Curr Opin Hematol* 1995;2: 484-92.
15. Horowitz B, Ben-Hur E. Viral inactivation of blood components: Recent advances. *Transfus Clin Biol* 1996;3:75-7.
16. Horowitz B, Bonomo R, Prince AM, Chin S, Brotman B, Shulman RW. Solvent/detergent-treated plasma: a virus-inactivated substitute for fresh frozen plasma. *Blood* 1992;79: 826-31.
17. Horowitz B, Prince AM, Hamman J, Watklevicz C. Viral safety of solvent/detergent-treated blood products. *Blood Coagul Fibrinolysis* 1994;5 Suppl 3:S21-S28.
18. International Conference on Harmonization. Guidance on quality of biotechnological/biological products: derivation and characterization of cell substrates used for production of biotechnological/biological products. *Fed Reg* 1998;63:50244-49.

19. International Conference on Harmonization. Guidance on viral safety evaluation of biotechnology products derived from cell lines of human or animal origin. Fed Reg 1998;63:51074-84.
20. Korwek EL. Human biological drug regulation: past, present and beyond the year 2000. Food and Drug Law J 1995;50:123-47.
21. Krishnan LA, Brecher ME. Transfusion-transmitted bacterial infection. Hematol Oncol Clin North Am 1995;9:167-85.
22. Lambrecht B, Mohr H, Knuver-Hopf J, Schmitt H. Photoinactivation of viruses in human fresh plasma by phenothiazine dyes in combination with visible light. Vox Sang 1991;60:207-13.
23. Larsson E, Kato N, Cohen M. Human endogenous proviruses. Curr Top Microbiol Immunol 1989;148:115-32.
24. Lederberg J, Shope RE, Oaks Sc Jr, editors. Emerging Infections. Microbial Threats to Health in the United States, Institute of Medicine. Washington, DC: National Academy Press; 1992.
25. Leveton LB, Sox HC Jr, Stoto MA, editors. HIV and the Blood Supply: An Analysis of Crisis Decisionmaking. Washington, DC: National Academy Press; 1995.
26. Lynch TJ, Weinstein MJ, Tankersley DL, Fratantoni JC, Finlayson JS. Considerations of pool size in the manufacture of plasma derivatives. Transfusion 1996;36:770-5.
27. Morgenthaler JJ, Omar A. Partitioning and inactivation of viruses during isolation of albumin and immunoglobulins by cold ethanol fractionation. Dev Biol Stand 1993;81:185-90.
28. Morse SS. Emerging viruses: defining the rules for viral traffic. Perspect Biol Med 1991;34:387-409.
29. Office of Regulatory Affairs and the Center for Biologics Evaluation and Research. Viral Clearance Processes for Plasma Derivatives and Inspectional Considerations. CP 7342.004 (Addendum); 1997.
30. Oshima KH, Evans-Strickfaden TT, Highsmith AK, Ades EW. The use of a microporous polyvinylidene fluoride (PVDF) membrane filter to separate contaminating viral particles from biologically important proteins. Biologicals 1996;24:137-45.
31. Pattison CP, Klein CA, Leger RT, et al. An outbreak of type B hepatitis associated with transfusion of plasma protein fraction. Am J Epidemiol 1976;103:398-407.
32. Pendergast WR. Biologic drug regulation. In: 75th Anniversary Commemorative Volume of Food and Drug Law. Washington, DC: Food and Drug Law Institute; 1984.
33. Sayers MH. Transfusion-transmitted viral infections other than hepatitis and human immunodeficiency virus infection. Cytomegalovirus, Epstein-Barr virus, human herpes virus 6, and human parvovirus B19. Arch Pathol Lab Med 1994;118:346-9.
34. Schreiber GB, Busch MP, Kleinman SH, Korelitz JJ. The risk of transfusion-transmitted viral infections. N Engl J Med 1996;334:1685-90.
35. Section 351 of the Public Health Service Act (42 U.S.C. 262).
36. Suomela H. Inactivation of viruses in blood and plasma products. Transfusion Med Rev 1993;7:42-57.
37. Tankersley DL, Mason BL, Guo Z-P, Yu MW. Viral safety of intravenous

immunoglobulin. In: Kazatchkine MD, Morell A, editors. Intravenous immunoglobulin research and therapy. New York: Parthenon; 1996. p. 3-9.

38. Wagner S. Transfusion-related bacterial sepsis. *Curr Opin Hematol* 1997;4:464-9.

39. Wallace EL, Churchill WH, Surgenor DM, et al. Collection and transfusion of blood and blood components in the United States, 1992. *Transfusion* 1995;35: 802-11.

40. Weinberg AN. Ecology and epidemiology of zoonotic pathogens. *Inf Dis Clin North Am* 1991;5:1-6.

---

1. The contents of this article represent the author's personal opinions and should not be construed as a statement of policy or position on the part of the U.S. Food and Drug Administration or any other component of the U.S. Government.



# Resistance “Creep” of Biological Indicators

Nigel A. Halls, Ph.D.

*Glaxo Wellcome Group Technical Services, U.K.*

# Introduction

The sterilization method of choice in the pharmaceutical industry is steam sterilization in autoclaves. This process is used for terminal sterilization of products and for sterilization of components, equipment, machine parts, etc. used in aseptic manufacturing. Modern autoclaves are highly reliable, computer-controlled, and allegedly fail-safe. Both the International Standards Organization and the European Committee for Standardization have recently published standards relating to industrial sterilization by saturated steam in autoclaves.

Millions of dollars are channeled each year into the validation of new autoclaves and into revalidation (validation maintenance checks) of existing steam sterilization processes. Much of this work is focused on biovalidation and bio-revalidation exercises which involve inactivation of heat-resistant microorganisms, most often spores of *Bacillus stearothermophilus*.

The purposes of this paper are to indicate how variations occurring in the thermal resistance of spores of *B. stearothermophilus* influence the value of bio-revalidation to its purpose of disclosing process deterioration which may have occurred due to change or 'wear and tear' over time, and to propose a way forward for resolving this issue.



# Process Development, Validation, and Revalidation

The manner in which populations of microorganisms are inactivated at high temperatures in steam autoclaves has been thoroughly researched. There is extensive evidence that populations of pure cultures of microorganisms are inactivated in a regular manner when exposed to saturated steam at practical sterilization temperatures. The form of inactivation is exponential; in other words, when the logarithm of the number of survivors is plotted against time at a particular temperature, the relationship takes the form of a straight line. The slope of this line is a measure of the resistance of any particular microorganism to steam sterilization. The measure used to express the slope is the  $D_T$ -value (the time at temperature  $T^\circ\text{C}$  required to reduce the population to 10% of its original numbers). When  $D$ -values are quoted without a suffix, it is usually understood that  $T$  is  $121^\circ\text{C}$  (i.e.,  $D_{121}$ -values).

## *Process Development*

The widespread confidence in the effectiveness of steam sterilization is based on the regularity of thermal inactivation of microorganisms. If the numbers and  $D$ -values of the microorganisms which actually or are likely to contaminate a particular product are known, it is comparatively easy to derive a specification for  $10^{-6}$  or any other level of sterility assurance. It should be emphasized, however, that such a specification relates specifically to the temperatures and times to which the microorganisms are actually exposed, and then only if the steam is saturated and air is absent. Different autoclaves may require different 'settings' to deliver these conditions to the microorganisms contaminating the product.

Process development is concerned with determining a detailed process specification which includes the correct 'settings' for the autoclave and for the condition of the product load. It must largely be done empirically. To obtain a temperature of  $121^\circ\text{C}$  within a product it could be necessary to set one autoclave's controller at  $121^\circ\text{C}$  and another autoclave's at  $123^\circ\text{C}$ . Even within a particular autoclave it could be possible that different temperature settings on the controller could be required to achieve the same temperature within different loads. Pre-exposure phases of the autoclave's cycle are also very important to achieving sterility, for instance, the numbers and depths of vacuum pulses are the main factors controlling air removal from the product. The nature and packaging of the product load is also an important determinant of air removal.

In the absence of any other wholly reliable means of determining that air is absent from complex product loads, biological experimentation using heat-resistant microorganisms is a necessary part of process development.

## *Validation and Revalidation*

The Performance Qualification phase of validation follows process development. Its purpose is to confirm that the process specification consistently achieves its intended purpose. Validation is a 'test'. The process is run according to its specification on three

(usually) separate occasions and measured against a variety of predetermined acceptance criteria. If the acceptance criteria are not achieved there may be a need for further development of the process.

Acceptance criteria for Performance Qualification normally include inactivation of heat-resistant microorganisms. In consideration of the extent and the thoroughness and history of the research evidence that microorganisms are inactivated in a regular fashion in response to temperature and time, it is periodically suggested that biovalidation should not be necessary where there is evidence of adequate heat penetration. In practice, however, providing a specific temperature and time within product may not achieve its expected lethality. Most frequently, such deviations from ideality occur because of inadequate air removal. The purpose of biovalidation is to confirm that the lethality expected from the process does not significantly deviate from ideality.

The purpose of bio-revalidation is to determine if there have been any unnoticed deteriorative changes in the process.

# Biovalidation

An important concept within the modern understanding of validation is the predetermination of a 'protocol' which defines criteria which must be complied with if the process is to be deemed valid (predetermined acceptance criteria). Acceptance criteria for biovalidation of steam sterilization processes are usually (but not invariably) defined along the following lines:

- $n$  biological indicators (BIs) will be placed in the load at locations defined in a drawing
- each BI will contain at least  $10^6$  viable spores of *B. stearothermophilus*
- the load will be exposed to a defined autoclave treatment (the validation cycle)
- the biovalidation will be considered satisfactory if no viable spores are recovered from the BIs after  $x$  days incubation at 55-60°C

In this context, biovalidation is a limit test. Only two results are possible — the validation cycle may be confirmed to be 'better' (more lethal, no spores recovered, meets acceptance criteria) than the sensitivity of the test, or 'worse' (less lethal, spores recovered, fails to meet acceptance criteria) than the sensitivity of the test.

The sensitivity of the BI limit test is defined by the numbers of spores per BI, by the thermal resistance of the spores (their  $D_T$ -values), and by the number of spores included in the load. For instance, biological indicators with  $10^6$  spores per BI present a more sensitive limit test than biological indicators with  $10^5$  spores per BI — greater numbers of spores per BI require longer exposures at any particular sterilization temperature to be killed than are required by small numbers of spores per BI. Similarly, spores with high D-values require longer exposures at any particular sterilization temperature (or higher temperatures for a particular specified time) for all of them to be killed than spores with low D-values.

In practical terms, it is quite possible to satisfactorily biovalidate several different sterilization cycles in different autoclaves against the same BI limit test system and acceptance criteria, but this does not mean that each cycle delivers the same lethality.

For biovalidation and bio-revalidation to be able to establish that lethality is delivered consistently and that changes over time have not impaired lethality, it makes sense that the BI limit test systems used on each occasion should not differ in their sensitivities.

## *Number of Spores per BI in the Biovalidation Limit Test*

The number of spores used per BI are comparatively easy to control. BIs are commercially available with different numbers of spores per indicator; BIs carrying  $10^6$  spores of *B. stearothermophilus* per indicator are commonly used in steam sterilization. This number is used for a number of reasons, in part because there is still a belief that the ability to inactivate  $10^6$  spores of *B. stearothermophilus* is a synonym for achieving a sterility assurance level (SAL) of  $10^{-6}$  (which is certainly not correct), and in part because there is a belief that Food and Drug Administration and Medicines Control Agency inspectors will not accept a sterilization process as properly validated unless it has been demonstrated that  $10^6$  spores have been inactivated (this, in the experience of the author, is

true for many investigators/inspectors/reviewers).

BIs carrying more than  $10^6$  spores are not readily commercially available. BIs carrying fewer than  $10^6$  spores present a less sensitive challenge in the context of a limit test. Given that  $10^6$  spores per BI appears also to be a regulatory expectation, it is reasonable and sensible to standardize the limit test in biovalidation and bio-revalidation at  $10^6$  spores per BI.

### *Number of BIs per Load in the Biovalidation Limit Test*

The number of BIs per load is very easy to control and usually, a double-digit number of BIs is used in each load. Figure 1 considers 'ideal' exponential inactivation of a population of a pure culture of microorganisms with a  $D_T$ -value of 2.5 minutes. The initial population contains  $10^6$  spores. Exposure to 15 minutes ( $6 \times D_T$ ) heat treatment would reduce the number of survivors in the population to one viable spore. Exposure to 17.5 minutes ( $7 \times D_T$ ) heat treatment would reduce the probability of one microorganism surviving from the population to  $10^{-1}$  (one chance in ten). In other words, if ten such populations were exposed to this treatment, one of them would probably still retain a survivor; if one hundred such populations were exposed, ten would probably retain survivors.

The same principles and conclusions may be applied to BIs if it is considered that each BI is an independent population of a pure culture of microorganisms. From this it can be seen that the number of BIs per load should be kept constant from occasion to occasion because it may influence the attainment of the acceptance criteria. In practice, the number of BIs used to validate the same steam sterilization process is sometimes varied from load to load, for instance, fewer BIs being used to validate a 'minimum' load. If this practice is followed, minimum loads will have a greater probability than maximum or typical loads of meeting the limit test acceptance criteria.

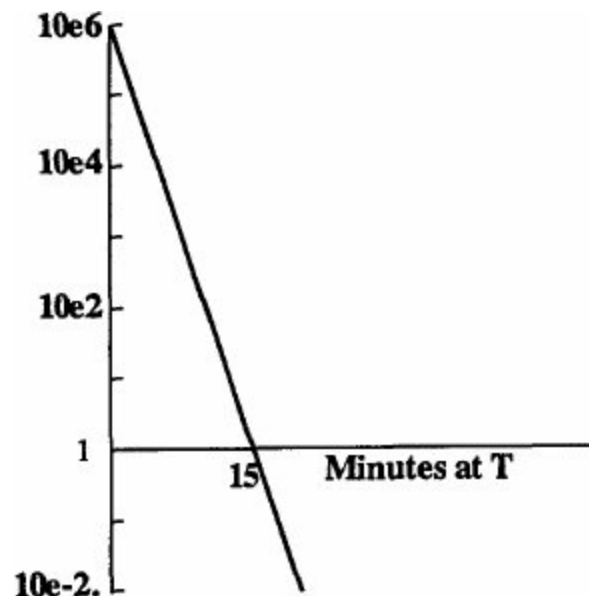

**Figure 1.** Ideal inactivation of a population of microorganisms with a D-value of 2.5 minutes at  $T^\circ\text{C}$ .

## The Validation Cycle

The autoclave 'settings' specified for validation cycles usually differ from those specified for routine cycles. The question which must be addressed is — what differences can be tolerated for the validation cycle to provide information which is still pertinent to routine processes?

Clearly, if biovalidation and bio-revalidation are performed to indicate that air removal is adequate, the pre-exposure settings and phases of cycle which are largely responsible for ensuring air removal must be the same in both validation and in routine conditions. Post-exposure phases which are often mainly concerned with load dryness may be curtailed or abbreviated in validation cycles.

It is not unusual to find that exposure conditions for validation cycles are set lower than the settings for routine cycles. This is supposed, when biovalidation results are satisfactory, to support the view that the routine cycle has an in-built overkill safety factor. A more scientifically justifiable reason for reducing the thermal lethality of the validation cycle is to poise it at a level where the biovalidation limit test is sensitive enough to disclose any deviations from ideality.

Figure 2 considers ideal inactivation of BI microorganisms which have a  $D_{121}$ -value of 1.5 minutes. The initial population per BI is  $10^6$  spores. Under ideal conditions there will be no more than one chance in one hundred of a spore surviving after 12 minutes exposure; if the biovalidation is done with ten BIs there will be no more than one chance in ten of failing to meet the acceptance criteria of no survivors. It should be quite clear from Figure 2 that any air-free autoclave cycle of longer than 12 minutes at  $121^\circ\text{C}$  will comply with this biovalidation limit test. The probability of this limit test being able to disclose deviations from ideality will diminish as the time of exposure of the validation cycle increases beyond 12 minutes. In other words, exposure to 12 minutes at  $121^\circ\text{C}$  is the sensitivity of the biovalidation for meeting its purpose of disclosing inadequate air removal from the load. The same sensitivity of the limit test can be extended to temperatures other than  $121^\circ\text{C}$  by applying the  $F_0$  principle.

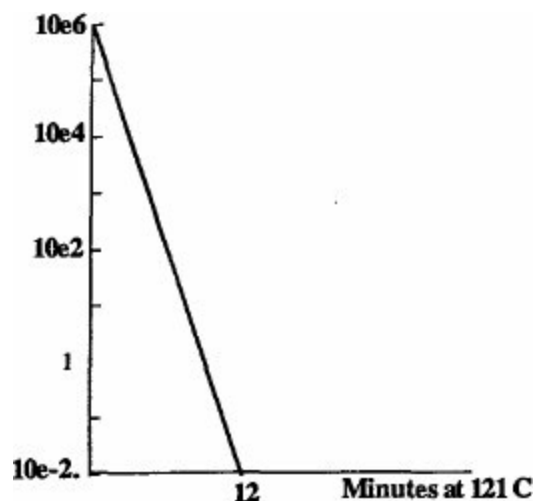
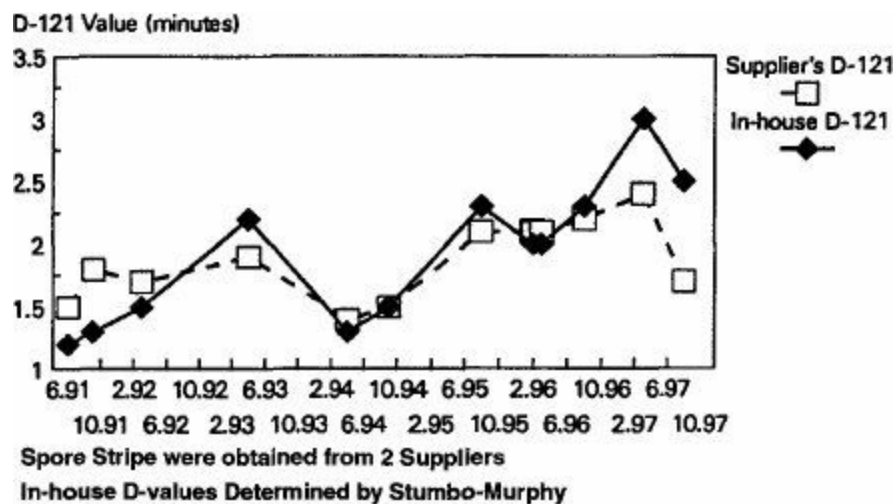

**Figure 2.** Ideal inactivation of a BI with a D-value of 1.5 minutes at  $121^\circ\text{C}$ .

autoclave cycles should not be allowed to differ from the temperature used in routine cycles because the lower steam pressures associated with lower temperatures may affect steam penetration into the load. The thermal input for validation cycles should be set somewhere close to the sensitivity of the BI test system used by adjusting the time of exposure. This may mean that validation cycles are set differently from occasion to occasion because of variations in the thermal resistance of the BIs available (see below).

### Thermal Resistance ( $D_T$ -values) of BIs

The sensitivity of a BI test system which maintains a constant number of spores per BI and a constant number of BIs per load, is determined by the thermal resistance ( $D$ -values) of the spores. *B. stearothermophilus* BIs are usually obtained from commercial sources, of which there are several. Figure 3 shows how the  $D_{121}$ -values of *B. stearothermophilus* BIs obtained from two commercial suppliers have “creeped” upwards through the 1990s. No criticism is being directed towards the two suppliers of *B. stearothermophilus* BIs, conformance with the United States Pharmacopoeia (USP) requires only that the  $D_{121}$ -values are within the range of 1.5 to 3.0 minutes.

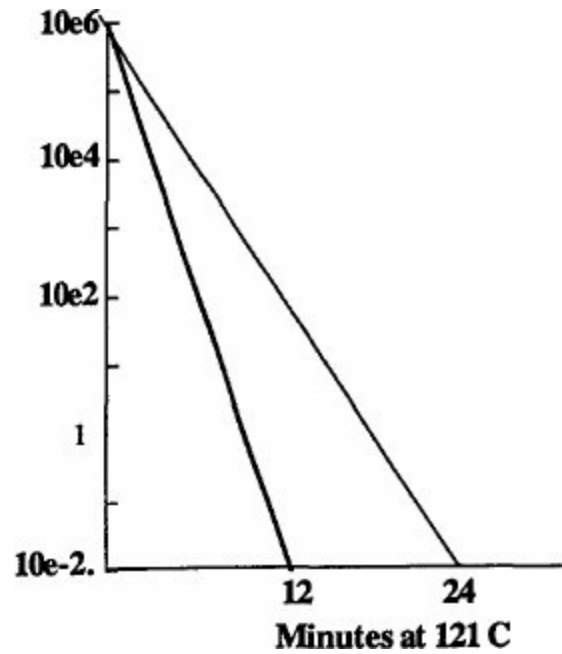

**Figure 3.** Resistance “creep” of commercially sourced *B. stearothermophilus* BIs since 1991.

It is certain that there is variation in the  $D_{121}$ -values of *B. stearothermophilus* spores, the range appears to be to the extremes allowed by USP. This variation is of significance to the sensitivity of the BI limit test.

Figure 4 considers the ideal inactivation of populations of BI microorganisms which have  $D_{121}$ -values of 1.5 minutes and of 3 minutes. The initial population per BI is  $10^6$  spores. Figure 4 indicates that an autoclave validation cycle which marginally but legitimately met acceptance criteria against ten BIs, each with  $10^6$  spores with  $D_{121}$ -values of 1.5 minutes, would very likely fail to meet bio-revalidation acceptance criteria against ten BIs, each with  $10^6$  spores with  $D_{121}$ -values of 3 minutes. The reason for the failure in the bio-revalidation, however, would not be related to air in load, steam quality, the engineering of the autoclave, nor to the preparation of the load — it would relate solely to the difference in thermal

resistance of the BIs used. In other words, unless the D-values of the spores used in biovalidation and bio-revalidation can be held constant, there is a significant risk of false failures, and indeed of false passes (if the situation described above were reversed, i.e., biovalidation done against spores with 3-minute  $D_{121}$ -values, and bio-revalidation against spores of 1.5-minute  $D_{121}$ -values).



**Figure 4.** Ideal inactivation of BIs with D-values of 1.5 and 3.0 minutes.

# A Way Forward

The difficulty of biovalidation and bio-revalidation is how to consistently achieve the intended purpose of disclosure of variations from ideal predictable sterilizing conditions when faced with variations in the thermal resistances of the BI spores available. The solution proposed in this paper is to consider the D-value of the available BIs for setting the time of exposure of the biovalidation cycles, and then to make the same considerations for setting the time of exposure of the bio-revalidation cycles in relation to the D-values of the BIs then available.

One way of doing this is to use a formula such as:

$$F_{0-val} = (\log s \times D_{121}) + (2 \times \log N \times D_{121})$$

where:

$F_{0-val}$  = the equivalent time at sterilizing temperatures of the validation cycle

$s$  = the number of spores per BI

$D_{121}$  = the thermal resistance of the BI spores

$N$  = the number of BIs used in the load

A validation cycle can be set for any temperature of exposure using this type of formula. The first part of the formula considers the lethality under ideal conditions necessary to reduce the number of spores in each biological indicator to one. Where D-values are low, the first part of the equation will contribute a smaller element of time to the validation cycle than it will when D-values are high. The second part of the equation takes into account the number of replicate BIs used, and of an arbitrary factor included to provide a reasonable confidence of avoiding failures associated purely with the statistics of exponential inactivation while at the same time providing a reasonable chance of detecting deviations from nonideality. The factor given in the formula example is 2, which ensures that failure from statistical reasons will occur no more frequently than one in one hundred cycles.

In practical terms, this equation would require a validation cycle  $F_0$  of 18 minutes for a biovalidation using 20 replicates of BI with  $10^6$  spores of  $D_{121}$ -value of 2.1 minutes, thus:

$$F_{0-val} = (6 \times 2.1) + (2 \times 1.3010 \times 2.1) = 18 \text{ minutes}$$

Bio-revalidation under the same circumstances, but with the available spores having  $D_{121}$ -values of 3 minutes, would require a validation cycle with an  $F_0$  of about 26 minutes, thus:

$$F_{0-val} = (6 \times 3) + (2 \times 1.3010 \times 3) = 25.8 \text{ minutes}$$

This type of approach and this type of formula allows a BI limit test of the same sensitivity to be applied consistently from biovalidation through successive bio-revalidations, thus allowing the biological work to serve its intended purpose of disclosing deviations from



ideal predictable sterilizing conditions.

Anyone with any practical experience of production-scale autoclaves will know, however, that validation cycles cannot be controlled to extremely precise exposure times or  $F_0$ -values. The calculated validation cycle is a minimum condition. A maximum limit must be set for validation conditions to be meaningful. The maximum limit for biovalidation to bio-revalidation cycles is likely to be a function of how precise the time of exposure or  $F_0$  can be controlled in particular autoclaves. As an absolute rule, a biovalidation cycle must not be longer than the routine production cycle. A pragmatic rule may be to set a maximum limit no more than half-way between the calculated minimum validation time and the time specified for the routine production cycle.



# Low-Temperature Sterilization Technologies<sup>1</sup>

William A. Rutala, Ph.D., M.P.H. and David J. Weber, M.D.,  
M.P.H.

*University of North Carolina (UNC) School of Medicine, U.S.A.*

Ethylene oxide (ETO) has been widely used as a low-temperature sterilant since the 1950s. It has been the most commonly used process for sterilizing temperature- and moisture-sensitive medical devices and supplies in health care institutions in the United States. Until recently, ETO sterilizers were combined with a chlorofluorocarbon stabilizing agent, most commonly in a ratio of 12% ETO mixed with 88% chlorofluorocarbons (referred to as 12/88 ETO). For several reasons, hospitals are exploring the use of new low-temperature sterilization technologies. First, chlorofluorocarbons were phased out in December 1995 under provisions of the Clean Air Act [13]. Chlorofluorocarbons were classified as a Class I substance under the Clean Air Act because of scientific evidence linking them to destruction of the earth's ozone layer. Second, some states (e.g., CA, NY, MI) require the use of ETO abatement technology to reduce the amount of ETO being released into ambient air by 90-99.9%. Third, the Occupational Safety and Health Administration regulates the acceptable vapor levels of ETO due to concerns that ETO exposure represents an occupational hazard [27]. These constraints have led to recent development of alternative technologies for low-temperature sterilization in the health care setting.

This paper is intended to provide a review of low-temperature sterilization technologies. The characteristics of an ideal low-temperature sterilization technology and the factors that influence the microbiocidal activity and clinical effectiveness of current technologies will be discussed. The advantages and disadvantages of new low-temperature sterilization technologies will be reviewed.

# Characteristics of an Ideal Low-Temperature Sterilization Process

New technologies should be compared against the characteristics of an ideal low-temperature (<60°C) sterilant (Table 1) [25]. While it is apparent that the ideal sterilant does not exist and all technologies have limitations (Table 2) [6,15,22], understanding the limitations imposed by restrictive medical device designs is critical for the proper application of low-temperature sterilization technology [16].

# Sterilization of Medical Devices

Medical devices which have contact with sterile body tissues or fluids are considered critical items. These items should be sterile when used since any microbial contamination could result in disease transmission. Such items include surgical instruments, biopsy forceps, and implants. If these items are heat resistant the recommended sterilization process is steam sterilization because it has the largest margin of safety. However, reprocessing heat- and moisture-sensitive items requires use of a low-temperature sterilization technology. Medical devices which come into contact with mucous membranes are considered semi-critical items. These items should be devoid of all microorganisms when used except possibly low levels of bacterial spores. Intact mucous membranes are generally resistant to infection by common bacterial spores but are susceptible to other organisms, such as tubercle bacilli and viruses. Respiratory therapy and anesthesia equipment, endoscopes, and cervical diaphragm fitting rings are included in this category [21].

Current medical devices offer many challenges for low-temperature sterilization processes. These include restrictive device designs including narrow lumens, long lumens, dead-end lumens, lumens with sharp angles, and crevices. Many medical devices may be contaminated with fluids containing organic material (e.g., blood, proteinaceous) and/or inorganic material (e.g., salts), both of which limit the effectiveness of sterilization technology.

**Table 1. Characteristics of an Ideal Low-Temperature Sterilant**

High Efficacy	The agent should be virucidal, bactericidal, tuberculocidal, fungicidal, and sporicidal.
Rapid Activity	Ability to quickly achieve sterilization.
Strong Penetrability	Ability to penetrate common medical device packaging materials and penetrate the interior of device lumens.
Material Compatibility	Produce negligible changes in either the appearance or function of processed items and packaging materials even after repeated cycling.
Nontoxic	Present no health risk to the operator or the patient and pose no hazard to the environment.
Organic Material Resistance	Withstand reasonable organic material challenge without loss of efficacy.
Adaptability	Suitable for large or small (point of use) installations.
Monitoring Capability	Monitored easily and accurately with physical, chemical, and biological process monitors.
Cost Effectiveness	Reasonable cost for installation and for routine operation.

# Alternative Ethylene Oxide Sterilization Technologies

Alternative technologies to ETO with chlorofluorocarbons which are currently available and cleared by the Food and Drug Administration (FDA) include: 100% ETO; ETO with a different stabilizing gas such as carbon dioxide or hydrochloro-fluorocarbons (HCFC); immersion in peracetic acid (e.g., Steris® System 1); and gas plasmas (e.g., AbTox™, STERRAD™). Technologies under development for use in health care facilities, but not cleared by the FDA, include: vaporized hydrogen peroxide, ozone vapor, vapor phase peracetic acid, gaseous chlorine dioxide, ionizing radiation, and pulsed light [26].

The use of ETO evolved when few alternatives existed for sterilizing heat- and moisture-sensitive medical devices; however, favorable properties (Table 2) account for its continued widespread use [6]. Two ETO gas mixtures are available to replace ETO-chlorofluorocarbon mixtures for large-capacity, tank supplied sterilizers. The ETO-CO<sub>2</sub> mixture consists of 8.5% ETO and 91.5% carbon dioxide. While this mixture is less expensive than ETO-hydrochlorofluorocarbons, a disadvantage is the need for pressure vessels rated for steam sterilization since higher pressures (28 psig) are required. The other mixture, which is a drop-in chlorofluorocarbon replacement, is ETO mixed with HCFC. HCFCs are about 50-fold less damaging to the earth's ozone layer. The Environmental Protection Agency will begin regulation of HCFC in the year 2015 and will ultimately cease production in the year 2030. Two companies provide ETO-HCFC mixtures as drop-in replacement for chlorofluorocarbon-12. One mixture consists of 8.6% ETO and 91.4% HCFC and the other mixture is composed of 10% ETO and 90% HCFCs [6].

# New Low-Temperature Sterilization Technologies

New sterilization technology which is based on plasma was patented in 1987 and marketed in the United States in 1993. The STERRAD 100, which is FDA cleared and in clinical practice, uses a single diffusion (hydrogen peroxide vapor >6 mg/L) and a plasma stage per sterilization cycle. The STERRAD 100S, which has not yet been FDA cleared, potentially improves sterilizer efficacy by utilizing two cycles of the diffusion and plasma stages per sterilization process. This revision, which is achieved by a software modification, reduces total processing time from 73 minutes to 52 minutes [8,23].

The AbTox system uses two alternating gases, a mixture of 1 mg/L peracetic acid vapor and 4 mg/L hydrogen peroxide vapor, and a mixture of oxygen, hydrogen, and argon gas. Both the STERRAD and AbTox system create a plasma by exposing a precursor gas or vapor to an electromagnetic field such as microwave or radio frequency energy. This results in a variety of charged and uncharged excited chemical species with excellent biocidal properties. The AbTox unit differs from the STERRAD system in two ways. First, the AbTox unit uses a nonplasma peracetic acid and hydrogen peroxide vapor phase that alternates with the plasma treatment. Second, the medical devices are exposed to only a secondary gas plasma from hydrogen and oxygen gases outside the sterilization chamber which flows into the chamber. These two phases (vapor and plasma) alternate a number of times depending on the cycle chosen. An air purge (“wash”) follows the sterilization cycle to remove remaining vapor [6,25].

**Table 2. Summary of Advantages and Disadvantages for Low-Temperature Sterilization Technologies**

Sterilization Method	Advantages	Disadvantages
Hydrogen Peroxide Plasma Sterilization STERRAD	<ul style="list-style-type: none"> <li>• Safe for the environment and health care workers</li> <li>• Leaves no toxic residuals</li> <li>• Cycle time is 75 minutes and no aeration necessary</li> <li>• Simple to operate, install (208 V outlet), and monitor</li> </ul>	<ul style="list-style-type: none"> <li>• Cellulose (paper), linens, and liquids cannot be processed</li> <li>• Sterilization chamber is small, about 3.5 ft<sup>3</sup></li> <li>• Endoscopes or medical devices with lumens &gt;40 cm or a diameter of &lt; 3 mm cannot be processed at this time in the United States</li> <li>• Requires synthetic packaging (polypropylene wraps, polyolefin pouches) and special container tray</li> <li>• Sterilization chamber is small, 5.5 ft<sup>3</sup></li> </ul>

## Plasma Sterilization (AbTox)

- Safe for the environment and health care workers
- Cycle time depends on load and varies from 30 minutes to 6 hours
- No corrosive effects and no harmful residues

- No liquids or products harmed by vacuum can be processed
- Limited to stainless steel surgical instruments (excludes lumen devices and hinged instruments) at this time
- Requires synthetic packaging in the United States

## 100% Ethylene Oxide (ETO)

- Penetrates packaging materials, device lumens
- Single-dose cartridge and negative pressure chamber minimizes the potential for gas leak and ETO exposure
- Simple to operate and monitor
- Compatible with most medical materials

- Requires aeration time to remove ETO residue
- Sterilization chamber is small, 4 ft<sup>3</sup> to 8.8 ft<sup>3</sup>
- ETO is toxic and a probable carcinogen
- ETO emission regulated by states but catalytic cell removes 99.9% of ETO and converts it to CO<sub>2</sub> and H<sub>2</sub>O
- ETO cartridges should be stored in flammable liquid storage cabinet
- Lengthy cycle/aeration time

## ETO Mixtures

12% ETO/88% CFC  
8.6% ETO/91.4% HCFC  
10% ETO/90% HCFC  
8.5% ETO/91.5% CO<sub>2</sub>

- Penetrates medical packaging and many plastics
- Compatible with most medical materials
- Cycle easy to control and monitor

- Some states (CA, NY, MI) require ETO emission reduction of 90 to 99.9%
- CFC (inert gas that eliminates explosion hazard) banned in 1995
- Potential hazards to staff and patients
- Lengthy cycle/aeration time
- ETO is toxic and a probable carcinogen

- Rapid cycle time (30 minutes)
- Environment friendly by-products

- Point-of-use system, no long-term storage
- Biological indicator may not be suitable for routine monitoring
- Used for immersible instruments only

## Peracetic Acid

Copyright © 2011 by AAMI. Full or partial reproduction, copying, and distribution prohibited.



(Steris)

- Sterilant flows through endoscope which facilitates salt, protein, and microbe removal
- Some material incompatibility (aluminum anodized coating becomes dull)
- One scope or a small number of instruments processed in a cycle

---

Modified from reference 22.

The Steris System 1 is a microprocessor-controlled, low-temperature sterilization method. The sterilant, 35% peracetic acid, and an anticorrosive agent are supplied in a single-dose container. The container is punctured by the user and the lid of the sterilizer is closed. The concentrated peracetic acid is diluted to 0.2% with filtered water ( $0.22\ \mu$ ) at a temperature of approximately  $50^{\circ}\text{C}$ . The diluted peracetic acid is circulated within the chamber of the machine and pumped through the channels of the endoscope for 12 minutes decontaminating exterior surfaces, lumens, and accessories. Interchangeable trays are available to permit the processing of up to three rigid endoscopes or one flexible endoscope. Connectors are available for most types of flexible endoscopes for the irrigation of all channels by forced flow. Rigid endoscopes are placed within a lidded container and the sterilant fills the lumens by passive flow. The peracetic acid is discarded via the sewer and the instrument rinsed four times with filtered water. Clean filtered air is passed through the chamber of the machine and endoscope channels to remove excess water.

# Microbiocidal Activity of New Low-Temperature Sterilization Technologies

Sterilization processes used in the United States must be cleared by the FDA and they require that sterilizer microbiocidal performance be tested under simulated use conditions [14]. The FDA requires that the test article must be inoculated with  $10^6$  colony forming units of the most resistant test organism prepared with organic and inorganic test loads. The inocula must be placed in various locations of the test articles, including those least favorable to penetration and contact with the sterilant (e.g., lumens). Cleaning prior to sterilization is not allowed in the demonstration of sterilization efficacy. A limited number of studies have evaluated the relative microbiocidal efficacy of these low-temperature sterilization technologies (Table 3) [2-5,7-10,15,17,18,23]. Most test methodologies use stainless steel or porcelain carriers which are inoculated with a test organism. Commonly used test organisms include vegetative bacteria, mycobacteria, and spores of *Bacillus* sp. The available data demonstrate that low-temperature sterilization technologies are able to provide a 6-log reduction of microbes when inoculated onto carriers in the absence of salt and serum. However, all of the available technologies are unable to reliably achieve complete inactivation of a microbial load in the presence of salt and serum.

The effect of salts and serums on sterilization processes was initially studied in the 1950s and '60s [1,20]. These studies showed that a high concentration of crystalline-type materials and a low protein content provided greater protection to spores than serum with a high protein content [18]. A study by Doyle and Ernst demonstrated resistance of spores by crystalline material applied not only to low-temperature sterilization technology but also steam and dry heat [12]. These studies showed that occlusion of *Bacillus subtilis* spores in calcium carbonate crystals dramatically increased the time required for inactivation as follows: 10 seconds to 150 minutes for steam ( $121^\circ\text{C}$ ), 3.5 hours to 50 hours for dry heat ( $121^\circ\text{C}$ ), and 30 seconds to >2 weeks for ethylene oxide ( $54^\circ\text{C}$ ). More recent investigators have corroborated and extended these findings [4,10,15,17]. While soils containing both organic and inorganic materials impair microbial killing, soils that contain a high inorganic salt to protein ratio favor crystal formation and impair sterilization by occlusion of organisms [12,18].

Alfa and colleagues demonstrated a 6-log reduction of the microbial inoculum of porcelain penicylinders using a variety of vegetative and spore-forming organisms (Table 3). However, if the bacterial inoculum was in tissue culture medium supplemented with 10% serum, only the ETO 12/88 and ETO-HCFC sterilization mixtures could sterilize 95 to 97% of the penicylinder carriers. The other plasma and ETO sterilizers demonstrated significantly reduced activity (Table 3). For all sterilizers evaluated which used penicylinder carriers (i.e., ETO 12/88, 100% ETO, STERRAD, AbTox) there was between a 3- to 6-log reduction of inoculated bacteria even in the presence of serum and salt. For each sterilizer evaluated, the ability to inactivate microorganisms in the presence of salt and serum was even further reduced when the inoculum was placed in a narrow lumen test object (3-mm diameter by 125-cm long). Although there was a 2- to 4-log reduction in microbial kill, less than 50% of the lumen test objects were sterile when processed using any of the

sterilization methods evaluated except the Steris System 1 (Table 3). Complete killing (or removal) of 6-logs of *Enterococcus faecalis*, *Mycobacterium chelonae*, and *B. subtilis* in the presence of salt and serum and lumen test objects was observed only for the Steris System 1 [5].

Bryce and coworkers studied the efficacy of the AbTox system using inoculated carriers (penicylinders, stainless steel washers, and surgical equipment). Test bacteria included *Staphylococcus epidermidis*, *E. faecalis*, *Pseudomonas aeruginosa*, and *Bacillus circulans*. In addition, they studied the effect of salt and protein by comparing bacteria grown in trypticase soy broth (TSB) with those grown in bovine serum albumin (BSA). The AbTox system was able to eliminate the test bacteria on 99% of carriers in the presence of BSA. However, the AbTox system was only able to eliminate the test bacteria on 63% of carriers in the presence of TSB. The efficacy of ETO-HCFC was 99.5% with BSA and 99.8% with TSB [10].

Rutala and colleagues studied the efficacy of a variety of new low-temperature technologies using *Bacillus stearothermophilus* inoculated onto stainless steel scalpel blades which were placed into lumen test objects (Table 3). Their results demonstrated that ETO-HCFC and the STERRAD 100S were highly effective in killing  $10^6$  *B. stearothermophilus* spores present in the center of narrow stainless steel lumen tubes. As the lumen diameter decreased, the STERRAD 100 demonstrated reduced ability to kill *B. stearothermophilus* spores present on the carrier. At the smallest diameter tested, 1 mm, the STERRAD 100 system failed 74% of the time. The Steris System 1 was not effective in completely eliminating the  $10^6$  inoculum using the authors' test conditions [23].

Narrow lumens provide a challenge to some low-temperature sterilization processes. For example, Rutala and colleagues showed that as lumen size decreased, increased failures occurred with the STERRAD 100. However, some low-temperature processes such as ETO-HCFC and the STERRAD 100S remained effective even when challenged by a lumen as small as 1 mm in the absence of serum and salt [23].

### **Table 3. Comparative Evaluation of the Microbiocidal Activity of Low-Temperature Sterilization Technology**

Low-Temperature Sterilization Technology

Challenge	ETO 12/88	100% ETO	HCFC-ETO	STERRAD 100	STERRAD 100S	AbTox	Steris	Reference
No salt or serum <sup>1</sup>	100% <sup>2</sup>	100%	96%	100%	ND	100%	ND	5
10% serum and 0.65% salt <sup>3</sup>	97%	60%	95%	37%	ND	32%	ND	5
Lumen (125 cm long × 3 mm wide) without serum or salt <sup>1</sup>	ND	96%	96%	ND	ND	ND	ND	5
Lumen (125 cm long × 3 mm wide) with 10% serum and 0.65% salt <sup>3</sup>	44%	40%	49%	35%	ND	6%	100% <sup>1</sup>	5
Lumen (40 cm long × 3 mm wide) <sup>4</sup>	ND	ND	100%	95%	100%	ND	8%	24
Lumen (40 cm long × 2 mm wide) <sup>4</sup>	ND	ND	100%	93%	100%	ND	ND	24
Lumen (40 cm long × 1 mm wide) <sup>4</sup>	ND	ND	100%	26%	100%	ND	ND	24
Lumen (40 cm long × 3 mm wide) <sup>5</sup>	ND	ND	100%	100%	100%	ND	ND	24

ND: no data

<sup>1</sup> Test organisms included *E. faecalis*, *M. chelonae*, *B. subtilis* spores.

<sup>2</sup> Numbers refer to the percent of carriers sterilized/number of replicates.

<sup>3</sup> Test organisms included *E. faecalis*, *P. aeruginosa*, *Escherichia coli*, *M. chelonae*, *B. subtilis* spores, *B. stearothermophilus* spores, *B. circulans* spores.

<sup>4</sup> Test organism was *B. stearothermophilus* spores. The lumen test units had a removable 5 cm center piece (1.2 cm diameter) of stainless steel sealed to the narrower steel tubing by hard rubber septums.

<sup>5</sup> Test organism was *B. stearothermophilus* spores. The lumen test units were a straight stainless steel tube.

The importance of allowing the sterilant to come into contact with the inoculated carrier is demonstrated by comparing the results of Alfa and Rutala as regards the Steris system [5,23]. Alfa demonstrated excellent activity of the Steris System 1 against three test organisms using a narrow lumen device. In these experiments the lumen test object was connected to channel irrigators which ensured that the sterilant had direct contact with the contaminated carriers. The data reported by Rutala demonstrated failure of the Steris System 1 to eliminate *B. stearothermophilus* spores from a carrier placed in a straight lumen test object. In these experiments the lumen test object was not connected to channel irrigators. The authors attributed the failure of the Steris System 1 to completely eliminate high levels of spores from the center of the test unit to the inability of the peracetic acid to diffuse into the center of 40-cm long, 3-mm in diameter tubes. Alfa and associates attributed the efficacy of the Steris system to the ability of the liquid chemical process to dissolve salts and remove protein and bacteria due to the flushing action of the fluid.

# Effect of Cleaning on Sterilization Efficacy

The data mentioned regarding the effect of salt and serum on the efficacy of low-temperature sterilization technologies have raised concern regarding their margin of safety. Experiments have shown that the salts have the greatest impact on protecting microorganisms from killing [5,18]. However, recent experiments by Jacobs and colleagues suggests that these concerns may not be clinically relevant. Jacobs *et al.* evaluated the relative rate of removal of inorganic soil, organic soil, and microorganisms from medical devices in order to better understand the dynamics of the cleaning process [18]. These tests were conducted by inoculating Alfa soil (tissue culture media and 10% fetal bovine serum) containing  $10^6$  *B. stearothermophilus* spores onto the surface of a stainless steel scalpel blade. After drying for 30 minutes at 35°C followed by 30 minutes at room temperature, the samples were placed in water at room temperature. The blades were removed at specified time periods, and the concentration of total protein and chloride ion were measured. The results showed that soaking in deionized water for 60 seconds resulted in a greater than 95% release rate of chloride ion from NaCl solution in 20 seconds, Alfa soil in 30 seconds, and fetal bovine serum in 120 seconds. Thus, contact with water for short periods of time even in the presence of protein rapidly leads to dissolution of salt crystals. Based on these experimental data, one can conclude that even minimal cleaning procedures would eliminate the potentially detrimental effect of high salt content on a low-temperature sterilization process (Table 4).

**Table 4. Effect of Static Soaking or Rinsing with Deionized Water or Tap Water on Sterilization<sup>1</sup> Results Obtained with High Salt Content Soil Containing *B. stearothermophilus* Spores<sup>2</sup>**

Treatment	Type of Water	# Organisms in Sample After Treatment	Sterility Results (# Positive/# Tested)
None	None	$1.5 \times 10^6$	60/60
Static Soak (60 Seconds)	Deionized Water	$2.5 \times 10^5$	0/60
Static Soak (60 Seconds)	Tap Water (220 ppm hardness)	$8.6 \times 10^4$	0/60
Rinse (60 Seconds)	Deionized Water	$6.0 \times 10^3$	0/60
Rinse (60 Seconds)	Tap Water (260 ppm hardness)	$2.8 \times 10^3$	0/60

Seconds)

hardness)

---

Modified from reference 18.

<sup>1</sup> Sterilization process was STERRAD 100 Sterilizer.

<sup>2</sup> Soil was tissue culture media with 10% fetal bovine serum containing  $1.5 \times 10^6$  *B. stearothermophilus* spores dried for 12 hours at room temperature.

# Bioburden on Medical Devices

In general, used medical devices are contaminated with a relatively low bioburden of organisms. Nystrom evaluated medical instruments used in general surgical, gynecological, orthopedic, and ear-nose-throat or operations and found that 62% of the instruments were contaminated with less than  $10^1$  organisms after use, 82% with less than  $10^2$ , and 91% with less than  $10^3$ . After washing in an instrument washer, more than 98% of the instruments had less than  $10^1$  organisms and none had more than  $10^2$  organisms [19]. Other investigators have published similar findings [11,24]. For example, Rutala and colleagues found that after a standard cleaning procedure, 72% of 50 surgical instruments contained less than  $10^1$  organisms, 86% less than  $10^2$ , and only 6% had greater than  $3 \times 10^2$  [24]. In a study by Chan-Myers and associates of rigid lumen medical devices, the bioburden on both the inner and outer surface of the lumen ranged from  $10^1$  to  $10^4$  organism per device. After cleaning, 83% of the devices had a bioburden less than or equal to  $10^2$  organisms [11]. In all of these studies, the contaminating microflora consisted mainly of vegetative bacteria usually of low pathogenicity (e.g., coagulase negative staphylococcus) [11,19,24].

# Challenges for the Future

The current FDA standards may be unnecessarily restrictive and too conservative [14]. The FDA should consider modifying their guidance documents to consider the combined effectiveness of cleaning and the subsequent sterilization process. Ideally, instrument or sterilization manufacturers should be able to demonstrate that cleaning followed by a sterilization process can inactivate a clinically relevant inoculum of highly resistant organisms in the presence of an organic and inorganic load that is placed into the most inaccessible location of the device. Additional studies need to be undertaken to assess the efficacy of cleaning on removing the organic load, inorganic load, and natural bioburden of contaminated instruments and lumened medical devices.

Device and sterilization manufacturers need to work closely together to develop devices more easily cleaned and sterilized.



# Conclusions

The key factors affecting the efficacy of a low-temperature sterilization process include the bioburden, the inherent susceptibility of the organisms (i.e., vegetative bacteria versus spores), protein load, salt concentration, and device design (e.g., lumen length and diameter) (Table 5) [3]. In general, used surgical devices have a low natural bioburden (i.e.,  $10^0$ - $10^3$ ) of mostly vegetative bacteria. With the exception of flexible gastrointestinal endoscopes, lumened medical devices also have a bioburden less than  $10^3$ . Used medical devices are commonly contaminated with blood and body fluids which results in protein and salt challenge. Cleaning is an essential component in reprocessing medical equipment as it reduces the bioburden, and removes salt and proteins which impair the effectiveness of sterilization. Based on the available but limited data, it appears that cleaning will remove the salt and serum that potentially interferes with the efficacy of low-temperature sterilization processes. When combined with adherence to standard cleaning protocols, the available data suggest that the currently FDA-cleared low-temperature sterilization technologies can inactivate a clinically relevant inoculum of highly resistant organisms.

**Table 5. Factors Affecting the Efficacy of Low-Temperature Sterilization**

Factors	Effect
Cleaning*	Failure to adequately clean instrument results in higher bioburden, protein load, and salt concentration. These will decrease sterilization efficacy.
Bioburden*	The natural bioburden of used surgical devices is $10^0$ to $10^3$ organisms which is substantially below the $10^6$ required for FDA clearance.
Pathogen type	Spore forming organisms are most resistant to sterilization and are the test organisms required for FDA clearance. However, the contaminating microflora on used surgical instruments consists mainly of vegetative bacteria.
Protein*	Residual protein decreases efficacy of sterilization. However, cleaning appears to rapidly remove protein load.
Salt*	Residual salt crystals decrease efficacy of sterilization more than protein load. However, cleaning appears to rapidly remove salt load.
Biofilm accumulation*	Biofilm accumulation reduces efficacy of sterilization by impairing exposure.
Lumen length	Increasing lumen length impairs sterilant penetration. May require forced flow through lumen to achieve sterilization.
Lumen diameter	Decreasing lumen diameter impairs sterilant penetration. May require forced flow through lumen to achieve sterilization.
Restricted flow	Sterilant must come into contact with microorganisms. Device designs which prevent or inhibit this contact (e.g., sharp bends, blind lumens) will decrease sterilization efficacy.

Single user license provided by AAMI. Further copying, networking, and distribution prohibited.

\* Factor only relevant for reused surgical/medical devices.

Currently, only the Steris System 1 is FDA-cleared for use with flexible endoscopes. This system allows the sterilant to flow continuously through the endoscope channels of flexible endoscopes when connected to channel irrigators. The importance of sterilant contact with the inner channel of the endoscope was demonstrated by Rutala and colleagues who showed that rigid endoscopes without connectors that allow sterilant flow through were not rendered sterile by the Steris System 1. Additional studies will be required to assess the efficacy of these new low-temperature sterilization processes for use with flexible endoscopes.

# References

1. Abbott CF, Cockton J, Jones W. Resistance of crystalline substances to gas sterilization. *J Pharm Pharmacol* 1956;8:709-21.
2. Alfa MJ. Plasma-based sterilization: The challenge of narrow lumens. *Infect Control Sterilization Tech* 1996;2:19-24.
3. Alfa MJ. Flexible endoscope reprocessing. *Infect Control Sterilization Tech* 1997;3:26-36.
4. Alfa MJ, DeGagne P, Olson N, Puchalski T. Comparison of ion plasma, vaporized hydrogen peroxide and 100% ethylene oxide sterilizers to the 12/88 ethylene oxide gas sterilizer. *Infect Control Hosp Epidemiol* 1996;17:92-100.
5. Alfa MJ, Olson N, DeGagne P, Hizon R. New low-temperature sterilization technologies: Microbicidal activity and clinical efficacy. In: Rutala WA, editor. *Disinfection, Sterilization, and Antisepsis in Healthcare*. Champlain (NY): Polyscience Publications; 1998. p. 67-78.
6. Anonymous. Ethylene oxide sterilization: How hospitals can adapt to the changes. *Health Devices* 1994;23:485-92.
7. Borneff M, Ruppert J, Okpara J, et al. Efficacy testing of low-temperature plasma sterilization (LTP) with test object models simulating practice conditions. *Zentr Steril* 1995; 3:361-71.
8. Borneff-Lipp M, Okpara J, Bodendorf M, Sonntag HG. Validation of low-temperature-plasma (LPT) sterilization systems: Comparison of two technical versions, the STERRAD 100, 1.8 and the 100S. *Hygiene und Mikrobiologie* 1997; rather than: 3:21-8.
9. Bradley CR, Babb JR, Ayliffe AJ. Evaluation of the Steris System 1 peracetic acid endoscope processor. *J Hosp Infect* 1995;29:143-51.
10. Bryce EA, Chia E, Logelin G, Smith JA. An evaluation of the AbTox plazlyte sterilization system. *Infect Control Hosp Epidemiol* 1997;18:646-53.
11. Chan-Myers H, McAlister D, Antonoplos P. Natural bioburden levels detected on rigid lumened medical devices before and after cleaning. *Am J Infect Control* 1997;25:471-6.
12. Doyle JE, Ernst RR. Resistance of *Bacillus subtilis* var. *niger* spores occluded in water-insoluble crystals to three sterilization agents. *Appl Microbiol* 1967;15:726-30.
13. Environmental Protection Agency. Protection of Stratospheric Ozone; Proposed Rule. *Fed Reg*. May 12, 1993.
14. Food and Drug Administration, Division of General and Restorative Devices. Guidance on Premarket Notification [510(k)] Submissions for Sterilizers Intended for Use in Health Care Facilities. March 1993.
15. Graham GS, Riley R. Sterilization manufacturers: Interactions with regulatory agencies. In: Rutala WA, editor. *Disinfection, Sterilization, and Antisepsis in Healthcare*. Champlain (NY): Polyscience Publications; 1998. p. 41-8.
16. Gross D. Ethylene oxide sterilization and alternative methods. *Surgical Services Management* 1995;1:16-17
17. Holler C, Martiny H, Christiansen B, Ruden H, Gundermann K. The efficacy of low-temperature plasma (LTP) sterilization, a new sterilization technique. *Zbl Hyg* 1993;

194:380-91.

18. Jacobs P. Cleaning: Principles and benefits. In: Rutala WA, editor. *Disinfection, Sterilization, and Antisepsis in Healthcare*. Champlain (NY): Polyscience Publications; 1998. p. 165-82.
19. Nystrom B. Disinfection of surgical instruments. *J Hosp Infect* 1981;2:363-8.
20. Royce A, Bowler C. Ethylene oxide sterilisation-some experiences and some practical limitations. *J Pharm Pharmacol* 1961;13:87t-94t.
21. Rutala WA, APIC Guidelines Committee. APIC guideline for selection and use of disinfectants. *Am J Infect Control* 1996;24:313-42.
22. Rutala WA, Weber DJ. Low-temperature sterilization technologies: Do we need to redefine "sterilization"? *Infect Control Hosp Epidemiol* 1995;17:87-91.
23. Rutala WA, Gergen MF, Weber DJ. Comparative evaluation of the sporicidal activity of new low-temperature sterilization technologies: 10/90 ethylene oxide, two plasma sterilization systems, and liquid peracetic acid. *Am J Infect Control* 1998;26:373-98.
24. Rutala WA, Gergen MF, Jones JF, Weber DJ. Levels of microbial contamination on surgical instruments. *Am J Infect Control* 1998;26:142-5.
25. Schneider PM. Low-temperature sterilization alternatives in the 1990s. *Tappi Journal* 1994;77:115-9.
26. Schneider PM. Emerging low-temperature sterilization technologies (non-FDA approved). In: Rutala WA, editor. *Disinfection, Sterilization and Antisepsis in Health Care*. Champlain (NY): Polyscience Publications; 1998. p. 79-92.
27. Weber DJ, Rutala WA. Occupational risks associated with the use of selected disinfectants and sterilants. In: Rutala WA, editor. *Disinfection, Sterilization, and Antisepsis in Health Care*. Champlain (NY): Polyscience Publications; 1998. p. 211-26.

---

1. Adapted with permission from an article submitted to *Infection Control and Hospital Epidemiology*.



# **Sterilization of Medical Devices, Pharmaceutical Components, and Barrier Isolation Systems with Gaseous Chlorine Dioxide**

**John B. Kowalski, Ph.D.**

*Johnson & Johnson, U.S.A.*

Gaseous chlorine dioxide is a rapid and effective sterilant. It is noncarcinogenic and nonflammable at sterilizing concentrations. For the product and packaging systems studied, residual chlorine dioxide is extremely low due to low absorption and/or rapid outgassing. Continuous real-time chlorine dioxide concentration monitoring is readily performed assuring process consistency and appropriate documentation for parametric release. Recent studies have demonstrated that gaseous chlorine dioxide sterilization can be applied to flexible and rigid barrier isolation system enclosures and bagged and unbagged pharmaceutical components. This paper will provide an overview of the key aspects of gaseous chlorine dioxide sterilization technology for medical products and its application in barrier isolation technology.

# Background

Chlorine dioxide (CD) has been recognized since the beginning of the century for its disinfecting properties. The issues surrounding the formation of chlorinated derivatives as reaction products from the use of chlorine in water and waste water treatment has spurred the investigation of alternative disinfectants. CD possesses the bactericidal, virucidal, and sporicidal properties of chlorine, but unlike chlorine, does not lead to the formation of trihalomethanes or react with ammonia to form chlorinated organic products (chloramines). These properties have led to the widespread use of CD in the treatment of drinking water.

## *Gaseous Chlorine Dioxide*

CD was discovered in 1811 and is a greenish-yellow gas with the common name euchlorine. It is a single-electron-transfer oxidizing agent that has a chlorine-like odor. CD is highly soluble in water but does not dissociate. It is a respiratory irritant with an 8-hour time-weighted average exposure limit of 0.1 ppm; the 15-minute short-term exposure limit is 0.3 ppm. The odor threshold is less than 1 ppm and exposure to greater than 10 ppm results in mucous membrane irritation.

Despite numerous applications for CD in aqueous systems, only recently have the properties of the gaseous form been investigated. Sporicidal activity of CD gas was not demonstrated until 1981. It was patented as a sterilant in 1985 [3,4] and was accepted by the EPA in 1988 for use as a sterilant. Sterilization studies with gaseous CD demonstrated potential applicability for medical product sterilization [1].

## *Advantages Versus Ethylene Oxide*

CD has been shown to have low toxicity in humans, is not mutagenic or carcinogenic, and is not an ozone-depleting chemical. Used at comparatively low concentrations and at subatmospheric pressure, gaseous CD sterilization lacks many of the hazards associated with ethylene oxide (EtO) and it has been suggested as an attractive potential replacement for EtO in some industrial sterilization applications [5]. Gaseous CD does not require expensive damage-limiting construction and is cost competitive with EtO. Capability for spectrophotometric in-chamber measurement of gas concentration makes the process amenable for the validation of parametric release.

# CD Sterilization System

CD gas cannot be compressed and stored in high-pressure cylinders, but is generated upon demand using a column-based solid phase generation system. The chemical reaction used for CD generation is based upon the reaction of solid flaked sodium chlorite with dilute chlorine gas:

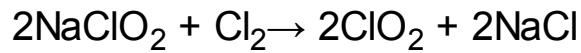

The flaked  $\text{NaClO}_2$  is packed into plastic columns. A gas mixture composed of 2%  $\text{Cl}_2$ /98%  $\text{N}_2$  is passed through the columns forming highly pure CD gas (approximately 100 mg/L) and sodium chloride. The gas is then diluted to the use concentration, usually between 10 and 30 mg/L. A block diagram for a CD gas generation system for a sterilizer-based installation is shown in Figure 1.

The output of the primary generation column is monitored by traditional or fiberoptic spectrophotometry, as is the gas mixture within the sterilization chamber. A secondary gas generation column is included in the system to prevent  $\text{Cl}_2$  from entering the sterilization chamber in the unlikely event of a physical defect in the primary generation column.

The sterilizer chamber (316L stainless steel) and the vacuum pump are similar to those used in EtO systems. The scrubber system utilizes a sodium thiosulfate solution to chemically convert the CD to sodium sulfate. The scrubber system is highly efficient; therefore, the effluent released into the atmosphere is mainly process  $\text{N}_2$  and air with the CD component reduced to low ppm levels.

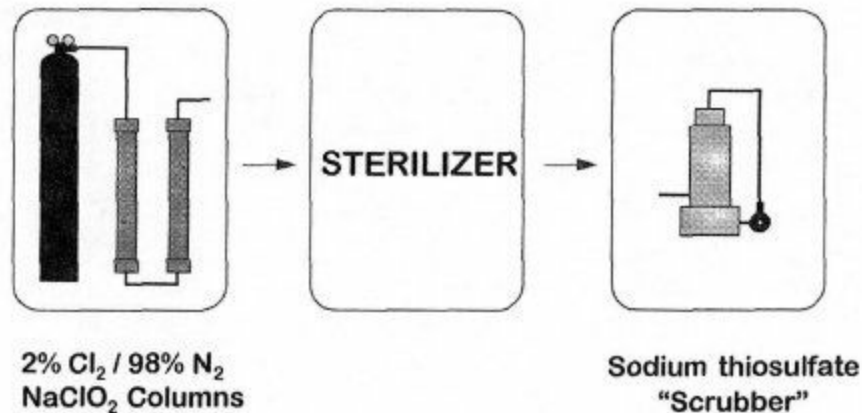

**Figure 1.** Block diagram of a  $\text{ClO}_2$  sterilizer system.



# Medical Product Sterilization

## Overwrapped Foil Suture Packages

Initial feasibility and range-finding studies on the application of gaseous CD for medical product sterilization were performed with overwrapped foil suture packages [2]. Sealed foil suture packages are placed within a Tyvek™/Mylar overwrap package which is then sterilized so the exterior of the foil package is sterile when introduced into the surgical field. In these studies, gaseous CD was substituted for EtO, the usual sterilization process.

The initial studies used a small (2-ft<sup>3</sup>) research sterilizer to develop a prototype CD sterilization process. The steps and their sequence were parallel to those used in other gaseous sterilization processes:

- External prehumidification prior to placement of the scaled-down “load” into the chamber
- Initial vacuum to remove air from the chamber and load
- Injection of CD gas to the desired concentration
- Exposure to the gas for the desired time period
- Final vacuum and air washes to remove the CD gas from the chamber and load

Paper strip biological indicators (BIs) containing 10<sup>6</sup> *Bacillus subtilis* spores were used to monitor process lethality. These preliminary studies demonstrated that CD was an effective sterilant in a gaseous system and, like EtO, that humidification of the load was important for rapid and complete sterilization.

Using the same research sterilizer, the next studies focused on the effect of CD gas concentration on the rate of inactivation of *B. subtilis* spores. This organism had been demonstrated to be the appropriate indicator organism for gaseous CD. The results of these studies are shown in Table 1.

As expected, as the CD concentration increases, the time it takes to attain all sterile BIs becomes progressively shorter. With this test system, only 30 minutes were required at 40 mg/L to sterilize the 10<sup>6</sup> *B. subtilis* BIs. This suggests that a 1-hour exposure time would yield a sterility assurance level (SAL) in the domain of 10<sup>-6</sup>. As these studies were performed in a small research sterilizer, the gas exposure time to reach an SAL of 10<sup>-6</sup> in a production-scale sterilizer would have to be carefully validated. Nonetheless, considering that the exposure was performed at slightly above room temperature (30 to 32°C) and the gas concentration was only 40 mg/L, extremely rapid sterilization kinetics were observed.

**Table 1. Effect of CD Gas Concentration on the Rate of Inactivation of 10<sup>6</sup> *B. subtilis* Spores on Paper Strips<sup>1</sup>**

Exposure Time (Minutes)	Fraction Nonsterile <sup>2</sup>		
	10 mg/L	20 mg/L	40 mg/L
0	NT	20/20	19/20
15	NT	19/20	1/20

30	20/20	4/20	0/20
60	9/20	0/60	0/20
90	3/60	NT	NT
180	0/20	NT	NT
240	0/20	0/20	NT

<sup>1</sup> The paper spore strips were placed next to the foil suture package and then overwrapped with Tyvek/Mylar. Sterilization exposures were performed at 30 to 32°C.

<sup>2</sup> NT = Not tested.

### Intraocular Lenses

More detailed CD sterilization process development and validation studies were performed using polymethylmethacrylate (PMMA) intraocular lenses (IOLs) as the test system. The studies were performed in a small (32-ft<sup>3</sup>) production-scale CD sterilization system equipped to perform in-chamber moisture conditioning and fiberoptic spectrophotometric gas concentration measurement.

The PMMA IOLs were contained in a polycarbonate lens case which was packaged in a Tyvek/Mylar peel pouch. The packages were placed upright in stainless-steel perforated trays (100 packages per tray). A rack system inside the sterilizer was used to hold the trays; the routine load was 800 lens packages, the maximum load configuration was 16 trays (1600 packages). A diagram of the sterilization process used for the IOL sterilization studies is shown in Figure 2. The process used in these studies was similar to that used for the overwrapped foil suture packages with two exceptions. For the intraocular lenses, load humidification was performed using in-chamber dynamic environmental conditioning (DEC). This process is a highly efficient intrachamber method for load humidification. Also, following CD gas charge, N<sub>2</sub> was added to the chamber to achieve a constant subatmospheric final pressure during gas exposure.

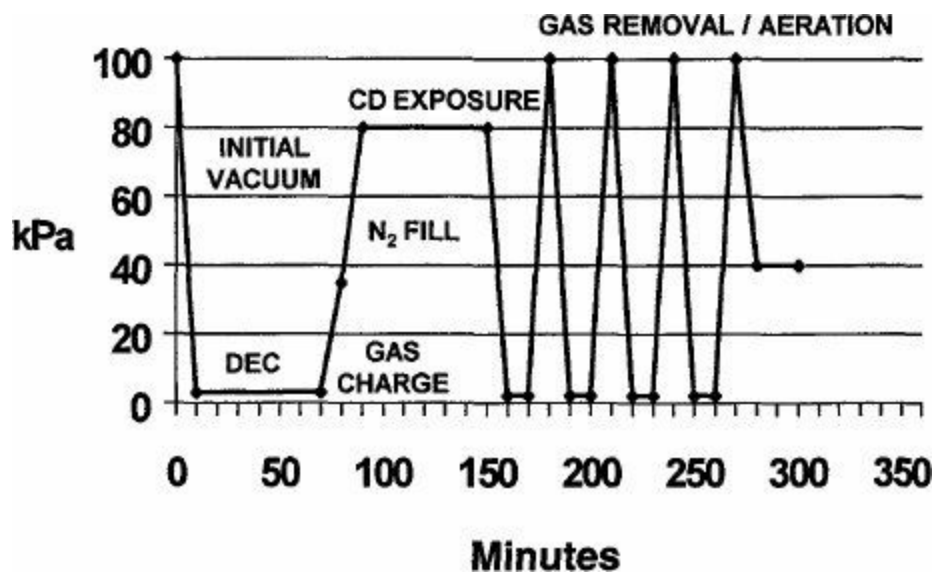

**Figure 2.** Process diagram for gaseous CD sterilization of IOLs.

Consistent with previous studies, a 30-minute gas exposure time yielded all sterile BIs with 800 IOL packages per load. To confirm and extend this observation, duplicate sterilization runs were performed with a load of 800 packages, a maximum sterilizer loading of 1600 packages, and a minimum load of 25 packages placed in a single tray in the center of the chamber. For the 800 and 1600 package loads, one BI was placed in the center of each sterilization tray. For the 25 package load, one BI was placed in each of the packages. The sterilization exposures were performed at 30 to 32°C with 60 minutes of in-chamber moisture conditioning at 75 to 90% relative humidity. The following results were obtained:

<u>Packages/Load</u>	<u>Fraction Nonsterile</u>
800	0/8, 0/8
1600	0/16, 0/16
25	0/25, 0/25

As can be seen, sterilization of the 10<sup>6</sup> *B. subtilis* BIs with 30 minutes of gas exposure was again observed and increasing or decreasing the load size had no measurable effect upon process lethality.

During the course of various process validation studies, numerous half- and full-cycle (30- and 60-minute gas exposure, respectively) sterilization runs were performed. The results for 24 half cycles and 31 full cycles were:

<u>Cycle Type</u>	<u>Fraction Nonsterile</u>
Half	0/361
Full	0/604

The gaseous CD process developed for the IOL product consistently delivered the expected process lethality and unexpected nonsterile BIs or “skips” were not observed.

# Barrier Isolation Applications

## Feasibility Studies

As flexible-wall barrier isolation systems became more widely used for product sterility testing, our view of the CD system diagram presented in Figure 1 evolved. Within reasonable limits, a CD gas generation system is unaffected by the size or location of the ultimate destination for the gas, the sterilizer. In actuality, the destination enclosure for the CD gas does not, in fact, need to be a sterilizer at all. Since the CD gas exits the generator at a modest positive pressure and flow rate, the destination enclosure also need not be evacuated and could be a sterility-testing isolator (STI), a glove box or sealed biological safety cabinet, or even a small room that could be sealed to prevent gas egress.

To test this hypothesis, a small (ca. 25-ft<sup>3</sup>) la Calhène flexible wall STI was modified by adding a gas inlet port in the canopy along with a pressure control line so that the internal pressure of the system could be maintained within specified limits. During charging of the isolator with CD gas, any excess pressure was released through the pressure control line which was connected to a CD gas scrubber system. Also installed in the system, via ports and tubing, was a spectrophotometric CD gas concentration monitor.

With the isolator configured so that there was no air exchange with the room environment and the internal circulation fan running, CD gas was introduced to a final concentration of 10 mg/L. The CD gas-air mixture was allowed to circulate for 30 minutes and then exhausted from the isolator by introducing room air and shunting the exhaust air to the CD gas scrubber system. Prior to the start of the experiment, ten 10<sup>6</sup> *B. subtilis* BIs were placed in a petri dish on the floor of the isolator.

Shortly after gas charge began, the inside of the isolator took on a greenish tint due to the color of the CD gas. When gas charge was terminated at the 10 mg/L setpoint, the inside of the isolator had a uniform, almost neon green, coloration. This coloration progressively diminished during the gas removal phase and the isolator returned to its original appearance.

After the 30-minute CD gas exposure in the isolator, all of the BIs were sterile. The appropriate controls were performed to demonstrate that residual CD gas bound to the BIs was not leading to false negative sterility test results.

To confirm these results and obtain preliminary information on the time required for the sterilization of a 10<sup>6</sup> *B. subtilis* BI, the feasibility study was repeated at CD gas (10 mg/L) exposure times of 5, 10, and 15 minutes. The following results were obtained:

<u>Minutes of Exposure</u>	<u>Fraction Nonsterile</u>
5	8/10
10	1/10
15	0/10

These results clearly demonstrated the potential for application of gaseous CD for the decontamination/sterilization of isolators and other enclosures.

## Isolator Geometry Testing

The visually uniform distribution of the CD gas within the STI suggested that all surfaces were equivalently treated. To test this observation, studies were performed with an empty isolator and with the isolator loaded with materials typically used for sterility testing. The testing configuration for the empty isolator studies is shown in Figure 3.

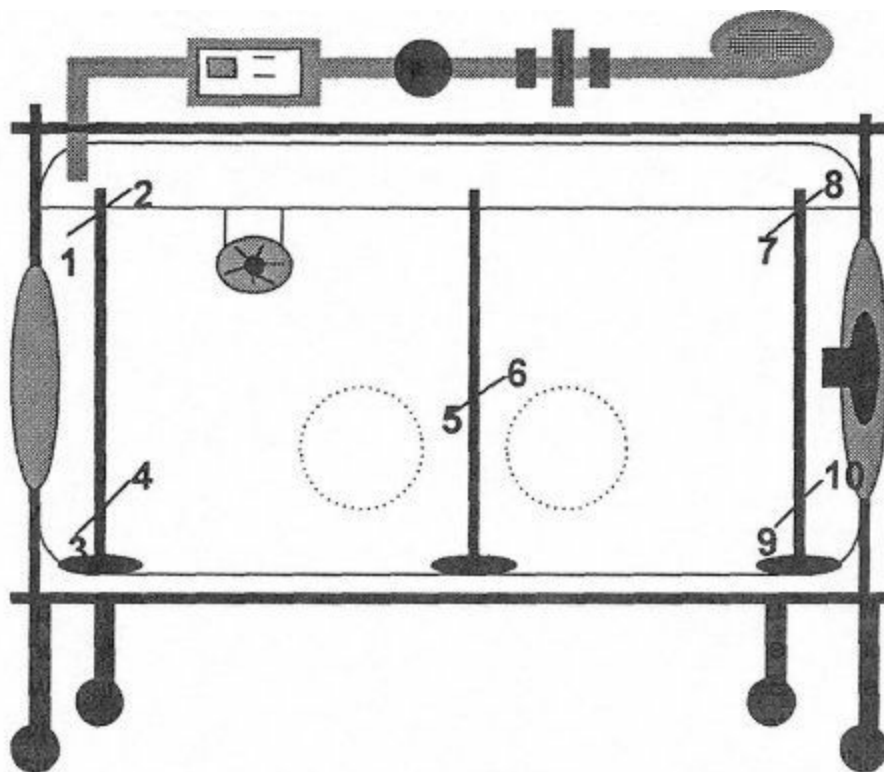

**Figure 3.** Diagram of a two-glove flexible wall STI showing the PVC stands for BI placement for isolator geometry studies.

Stands fabricated from rigid polyvinyl chloride (PVC) rod (known not to bind significant amounts of CD) were placed into the isolator, as depicted in Figure 3. BIs were suspended from the ends of the rods and exposed to 10 mg/L of CD gas for various time periods. With a 7-minute exposure to CD gas, the following results were obtained:

<u>BI Position</u>	<u>Fraction Nonsterile</u>
1	2/6
2	2/6
3	2/6
4	2/6
5	4/6
6	2/6
7	0/6
8	4/6
9	1/6
10	3/6

As can be seen, all of the positions yielded similar results. When the exposure time was extended beyond 7 minutes, all BIs at all positions were sterilized (data not shown). In repetitions of experiments of this type, no BI position(s) could be identified that consistently differed in fraction nonsterile results. This result confirmed the visual observation that gas distribution was uniform within the STI.

To test for uniform and adequate gas distribution in a loaded STI, materials typical for sterility testing were placed inside the STI along with BIs located within the isolator load. The configuration of the materials within the isolator is shown in Figure 4. With this configuration and others (not shown), all BIs were sterilized after exposure to CD gas for 30 minutes at 10 mg/L.

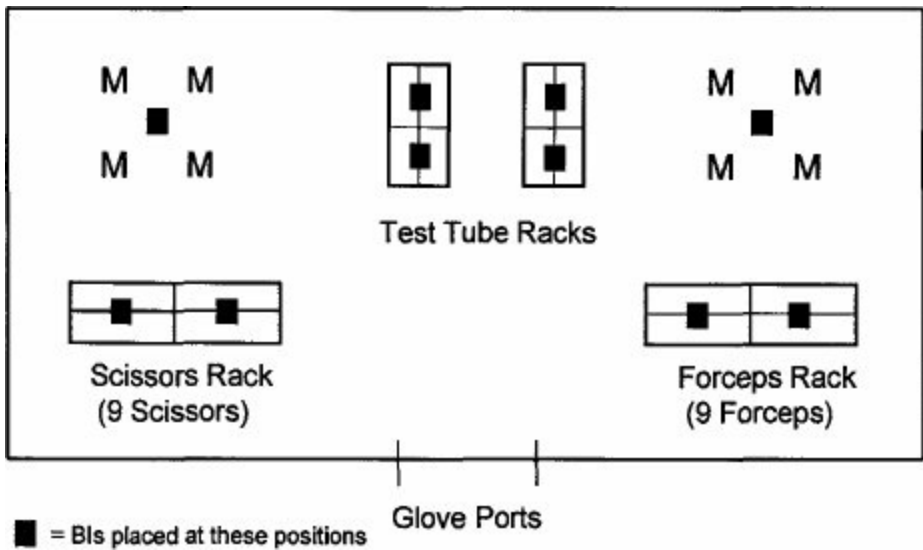

**Figure 4.** Plan view of sterility testing materials on the floor of a 25-ft<sup>3</sup> STI. “M” designates the position of a media-filled mason jar.

*D-value Versus CD Concentration*

Initial studies on the efficacy of gaseous CD for the decontamination/sterilization of an STI used a gas concentration of 10 mg/L. This concentration yielded a relatively rapid process with six log reductions of resistant spores in approximately 15 minutes. The effect of CD gas concentration upon the observed D-value with *B. subtilis* spores was determined at 10,20, and 30 mg/L of CD in an empty isolator. The study was designed to have the gas exposure time as “square wave” as possible. The following results were obtained:

<u>mg/L CD</u>	<u>D-value in Seconds</u>
10	45
20	16
30	7

As expected, the D-value decreases with increasing CD concentration.

**STI Sterilization Process**

Reproduction, copying, networking, and distribution prohibited.

The microbiological studies described above led to the development of the STI sterilization process shown in Figure 5. As with the medical product sterilization application, the STI process begins with a moisture conditioning step at 70 to 85% relative humidity for 30 minutes. The STI is then charged with CD gas, with a fill time of approximately 3 minutes. The gas exposure phase is approximately 30 minutes to attain 12 log reductions with *B. subtilis* spores. As CD gas has a low affinity for the PVC canopy material (see below), gas removal/aeration from the STI is relatively rapid. In rigid-wall isolation systems, gas removal/aeration can be extremely rapid, being directly related to the air change capability of the air handling system and the capacity of the CD scrubber system.

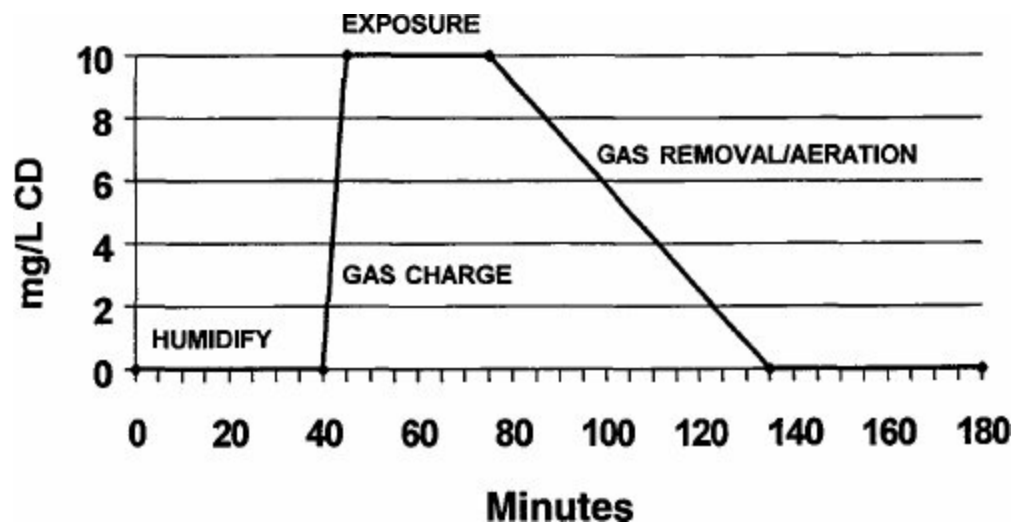

**Figure 5.** Process diagram for gaseous CD sterilization of a 25-ft<sup>3</sup> STI.

### *CD Residuals and Materials Effects*

Very low residuals of CD are observed when examining medical products and packaging materials as well as components of isolation technology systems. CD does not appear to have the 'solvent-like' quality of EtO; residual CD is generally less than 10 ppm following a 15-minute exposure at 10 mg/L. Rapid aeration is also observed with levels often less than 1 ppm following 15 minutes of aeration.

Figure 6 shows an aeration curve for a sample of la Calhène PVC canopy material exposed to 10 mg/L of CD for 15 minutes in an STI. As can be seen, approximately 2 ppm of residual CD was observed immediately after gas exposure was completed with the levels declining to less than 0.5 ppm in less than 30 minutes. This aeration profile indicates that STI systems, decontaminated or sterilized with gaseous CD, will have minimal postexposure down time due to sterilant aeration.

The impact of CD exposure on a number of polymeric materials and metals has been evaluated. Commonly used polymers such as ABS, nylon, PMMA, polyethylene, polypropylene, polystyrene, Teflon, and Viton appear highly compatible. Polycarbonates and polyurethanes, depending upon the particular formulation, may exhibit a loss in tensile properties and/or discoloration. Changes observed in color or physical properties may be attributed to additives or variation in polymer formulation and/or processing. Stainless steel is compatible with CD, uncoated copper and aluminum are highly affected.

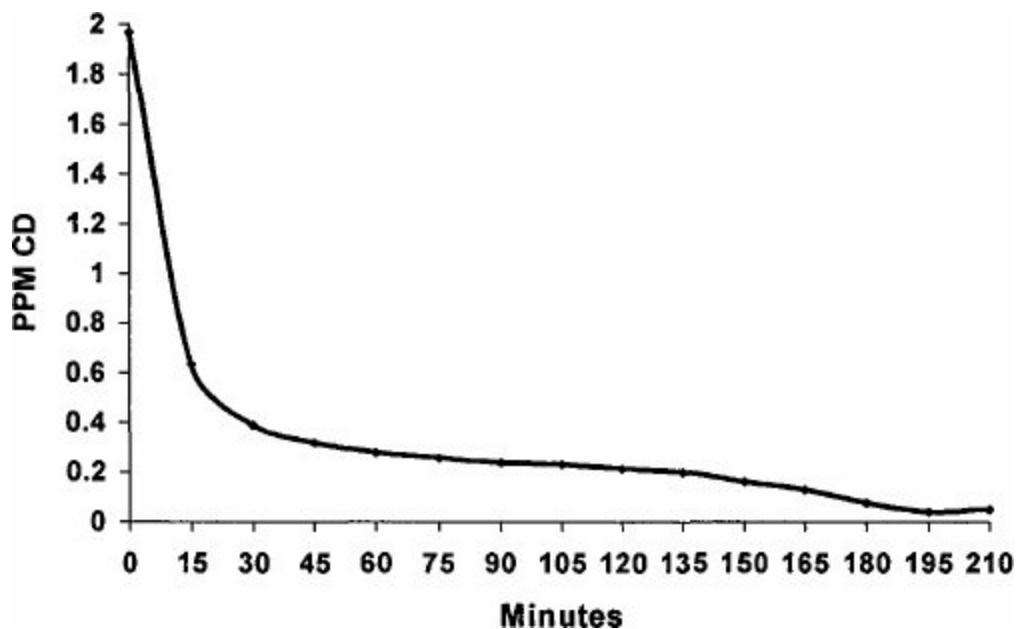

**Figure 6.** Aeration of CD from flexible wall isolator PVC (la Calhène). Aqueous extraction from treated samples (10mg/L, 15 minutes) followed by polarographic measurement of dissolved CD.



# Conclusions

Studies presented in this paper confirm that CD is a rapid and effective sterilizing agent. In addition to being a potential replacement for EtO for compatible medical devices, it is also very well suited for the sterilization of flexible- and rigid-wall barrier isolation systems.

# Acknowledgments

The contributions of Ms. B. Koehler, Ms. L. Lavelle, Ms. L. Kimak, Ms. D. Battisti, and Dr. J. Hauschild to these studies are gratefully acknowledged.

# References

1. Knapp JE, Rosenblatt DH, Rosenblatt AA. Chlorine dioxide as a gaseous sterilant. *Med Dev Diagn Ind* 1986;8:48-51.
2. Kowalski JB, Hollis RA, Roman CA. Sterilization of overwrapped foil suture packages with gaseous chlorine dioxide. In: Pierce G, editor. *Developments in Industrial Microbiology*. Volume 29. Amsterdam: Elsevier Science Publishers B.V.; 1988. p. 239-45
3. Rosenblatt DH, Rosenblatt AA, Knapp JE. Use of chlorine dioxide gas as a chemosterilizing agent. United States Patent, No. 4,504,442; 1985.
4. Rosenblatt DH, Rosenblatt AA, Knapp JE. Use of chlorine dioxide gas as a chemosterilizing agent. United States Patent, No. 4,681,739; 1987.
5. Woodworth AG, Jeng DK. Chlorine dioxide sterilization under square-wave conditions. *Appl Environ Microbiol* 1990;56:514-9.



# Development of Biological and Chemical Indicators for Monitoring Vapor-Phase Hydrogen Peroxide Sterilization Processes and Evaluation of Performance Using a Biological Indicator Evaluator Resistometer Vessel

Thomas B. May, Ph.D. and Michael S. Korczynski, Ph.D.

*Abbott Laboratories, U.S.A.*

A biological indicator system was developed for testing the efficacy of the Vapor-phase Hydrogen Peroxide (VHP™) sterilization process, whereby stainless steel coupons were inoculated with *Bacillus subtilis* or *Clostridium sporogenes* and then placed in polyethylene envelopes. The method is amenable to use with other spore-forming organisms or bioburden isolates. D-value analysis was performed using a Biological Indicator Evaluator Resistometer (BIER) vessel that was specifically designed to give square wave kinetics relative to VHP exposure. Actual VHP concentrations within the BIER vessel were determined using a newly developed chemical indicator system or AOTF-NIR instrumentation. Several factors were found to be critical for obtaining reproducible D-values, of which controlled prehumidification of the biological indicators was found to be the most important. A model of VHP lethality and predicted spore logarithmic reduction was developed from this data, thereby allowing control of VHP cycles using a lethality concept designated as  $F_v$ .

# Introduction

Hydrogen peroxide solution has a long history as a disinfectant and has been shown to have bactericidal, virucidal, and sporicidal capabilities in 10 to 30% concentrations [6]. More recently, Vapor-phase Hydrogen Peroxide (VHP™) has been used as an alternative to liquid disinfection methods as well as to more toxic gaseous sterilants such as ethylene oxide and formaldehyde. Although VHP is somewhat limited by its ability to penetrate materials, it has a clear advantage over other gaseous sterilants in that it is effective at concentrations less than 10 mg/L, at ambient temperatures, and that it decomposes to nontoxic water vapor and oxygen [11]. VHP technology is gaining approval in the medical and pharmaceutical industries. Decontamination and surface sterilization of biohazard hoods, centrifuges, lyophilizers, sterility isolators, and aseptic production isolators are just a few of the applications for VHP sterilization. However, full implementation of the technology has been hampered by a lack of tools necessary to understand the critical parameters affecting biological kill.

The VHP 1000 generator relies on weight and airflow velocity to assess the amount of VHP injected into an enclosure or chamber [11]. Although this simple method provides a reasonable measure of output from the VHP generator, the actual amount of VHP delivered to the chamber can only be predicted. Until recently, this has been a major obstacle to validation of VHP processes. The advent of Acousto-Optic Tunable Filter Near-Infra Red (AOTF-NIR) instrumentation to measure actual VHP concentrations has greatly improved process monitoring [2,3,15] and has been shown to simplify VHP cycle development [3].

This paper describes some additional tools (e.g., biological indicators, chemical indicators, D- and z-values, and Biological Indicator Evaluator Resistometer [BIER] vessels) that are necessary for measuring biological resistance to VHP. The ability to measure biological resistance, as well as to continuously monitor VHP concentration, led to development of the  $F_v$  concept. The  $F_v$  terminology is analogous to  $F_0$  for moist heat sterilization except that the AOTF-NIR cell serves as the 'thermocouple.' In other words, VHP sterilization cycles can be based on lethality rather than just time and VHP concentration.

# Materials and Methods

## *Preparation of Biological Indicators*

*Clostridium sporogenes* (derived from ATCC 7955) and *Bacillus subtilis* var. *niger* (derived from ATCC 9372) were selectively cultured, propagated, and harvested to attain spores of specified moist heat and dry heat resistance, respectively. Each spore suspension contained approximately  $1 \times 10^8$  spores/mL. Vegetative *C. sporogenes* cells were propagated anaerobically on Yeast Extract Agar (YEA) medium from BBL™ for a minimum of 3 days at 32 to 37°C. Vegetative *B. subtilis* cells were grown aerobically for a minimum of 2 days at 30 to 35°C on Soybean Casein Digest Agar (SCDA) medium from Difco Laboratories. Biological indicators were prepared by inoculating 1-cm<sup>2</sup> stainless steel coupons with 0.01 mL of the appropriate spore suspension. The inoculum was placed on the coupons in multiple, discrete spots and allowed to dry in a biosafety cabinet. Each biological indicator unit contained three inoculated coupons sealed in polyethylene envelopes that were constructed from 2.25 mil Whirlpak® bags. The polyethylene envelope was constructed by heat sealing a strip just larger than three coupons in a manner that each coupon fit into an individual pouch. Survivors were enumerated by the direct plate method as previously described [1] with the exception that the coupons were sonicated for 20 minutes in 10 mL of buffer prior to plating appropriate dilutions.

## *Preparation of Chemical Indicators*

A colorimetric method for detection of oxidizing agents, including hydrogen peroxide, was adapted for detection of VHP. The method is based on the ammonium molybdate catalyzed oxidation of potassium iodide to yield a yellow colored triiodide that absorbs at 353 nm [7]. The VHP chemical indicator consisted of a 25.0 mm × 37.5 mm × 2.25 mil polyethylene pouch containing 0.5 mL of the chemical reagent mixture. The reagent mixture was heat sealed into the pouch using a short heat and long dwell time to prevent solution-induced seal cracking. Each 5 mL of chemical reagent mixture contained 2.45 mL distilled water, 2.50 mL of 0.2 M KI, and 0.05 mL of 0.5% (NH<sub>4</sub>)<sub>6</sub>M<sub>7</sub>O<sub>24</sub>. A standard curve was generated per the original assay method [7].

## *BIER Vessel*

Figure 1 shows a schematic diagram of the VHP BIER vessel. The vessel was specifically designed to give square wave kinetics relative to VHP exposure by using a plunger system and by maintaining a sufficiently small size to yield steady state VHP concentrations. Another key feature of this vessel is a second chamber connected to a vacuum-air wash system to remove residual VHP. An AOTF-NIR detector from Rosemont Analytical (Orrville, OH) was used in conjunction with the chemical indicators to monitor VHP concentrations within the BIER vessel.

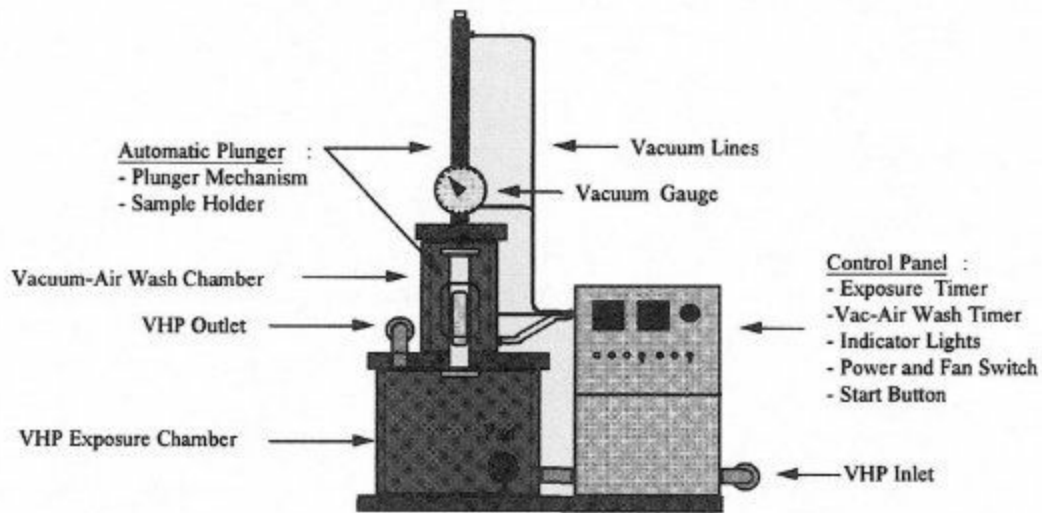

**Figure 1.** VHP Biological Indicator Evaluator Resistometer Vessel. The chamber temperature can be controlled as necessary by using a separate heat exchanger system on the inlet side of the vessel. In addition, a separate chamber was attached to the outlet side of the BIER vessel to house a VHP detector cell.



# Results and Discussion

## *Development of a VHP Biological Indicator System*

*B. subtilis* and *C. sporogenes* are spore-forming organisms that have been used as biological indicators to monitor various sterilization processes. *B. subtilis* has demonstrated resistance against dry heat and ethylene oxide; *C. sporogenes* is a moist heat resistant organism. These two organisms were readily available and were chosen as VHP biological indicators for these studies. Other spore-forming organisms would also be appropriate. The key criterion is that the indicators are more resistant than the bioburden typically presented to the VHP process.

Stainless steel was chosen as the inoculum substrate (coupon) because it is nonporous, surviving spores are easily recovered from this surface, and stainless was previously used for VHP biological indicators [11]. Stainless also has the advantage that it will limit kill from residual hydrogen peroxide. In addition, stainless steel represents a major component of equipment that is sterilized by VHP. The inoculated stainless steel coupons were also enclosed in polyethylene envelopes. The polyethylene envelope acts as a barrier to environmental contamination and is convenient when sterilization occurs in a different location from testing. VHP penetration of polyethylene is slightly less than reported for Tyvek® [12]. However, polyethylene was chosen over Tyvek and other materials based on lower peroxide residuals [12].

## *Biological Resistance*

Figures 2 and 3 show survivor curves for the *B. subtilis* and *C. sporogenes* biological indicator systems, respectively. An initial lag period was observed for both organisms before the onset of VHP kill. This result has previously been observed for many different types of spore-forming organisms in various modes of sterilization [9]. The polyethylene envelope likely contributes somewhat to this lag period. Hydrogen peroxide vapor, however, was found to penetrate the polyethylene envelope almost instantaneously (described below). The data was more variable at lower peroxide injection rates and may be due to less consistent delivery of the vapor by the VHP generator (data not shown). The survivor curves demonstrate comparable resistance (D-values) for both spore formers at three different exposures (Figures 2 and 3). D-values are defined as the time required to effect a one logarithm change in the number of survivors. The z-value, i.e., the change in VHP concentration necessary to change the D-value by a factor of one logarithm, was calculated to be 1138 ppm for *B. subtilis* and 1394 ppm for *C. sporogenes*.

*Bacillus stearothermophilus* is another spore former commonly used as a VHP biological indicator. Although direct comparative resistance analysis was not performed with *B. stearothermophilus*, the D-values for *B. subtilis* and *C. sporogenes* described in this study appear to be similar to previous reports for *B. stearothermophilus* on stainless coupons without the polyethylene envelope [11]. In practice, the biological indicators described in this study are more resistant than *B. stearothermophilus* on bare stainless coupons (Table 1).

## *Factors Affecting the D-value Analysis*

There are multiple factors that can influence the D-value obtained for the biological indicators. For instance, the inoculum was originally placed on the coupon as a single spot. The inoculation procedure was subsequently changed to a multiple-spotting technique to reduce the plate count variability (data not shown). A thick inoculum appeared to result in protection of the underlying spores from VHP exposure as VHP has poor penetrating power. Spreading the inoculum over a larger surface also reduces the layering effect observed when spore suspensions dry. The orientation with respect to the airflow, distribution of VHP within the BIER vessel, and temperature were also found to influence D-values to some extent (data not shown). Most of these factors are controlled by following standard procedures and by using an automated BIER vessel.

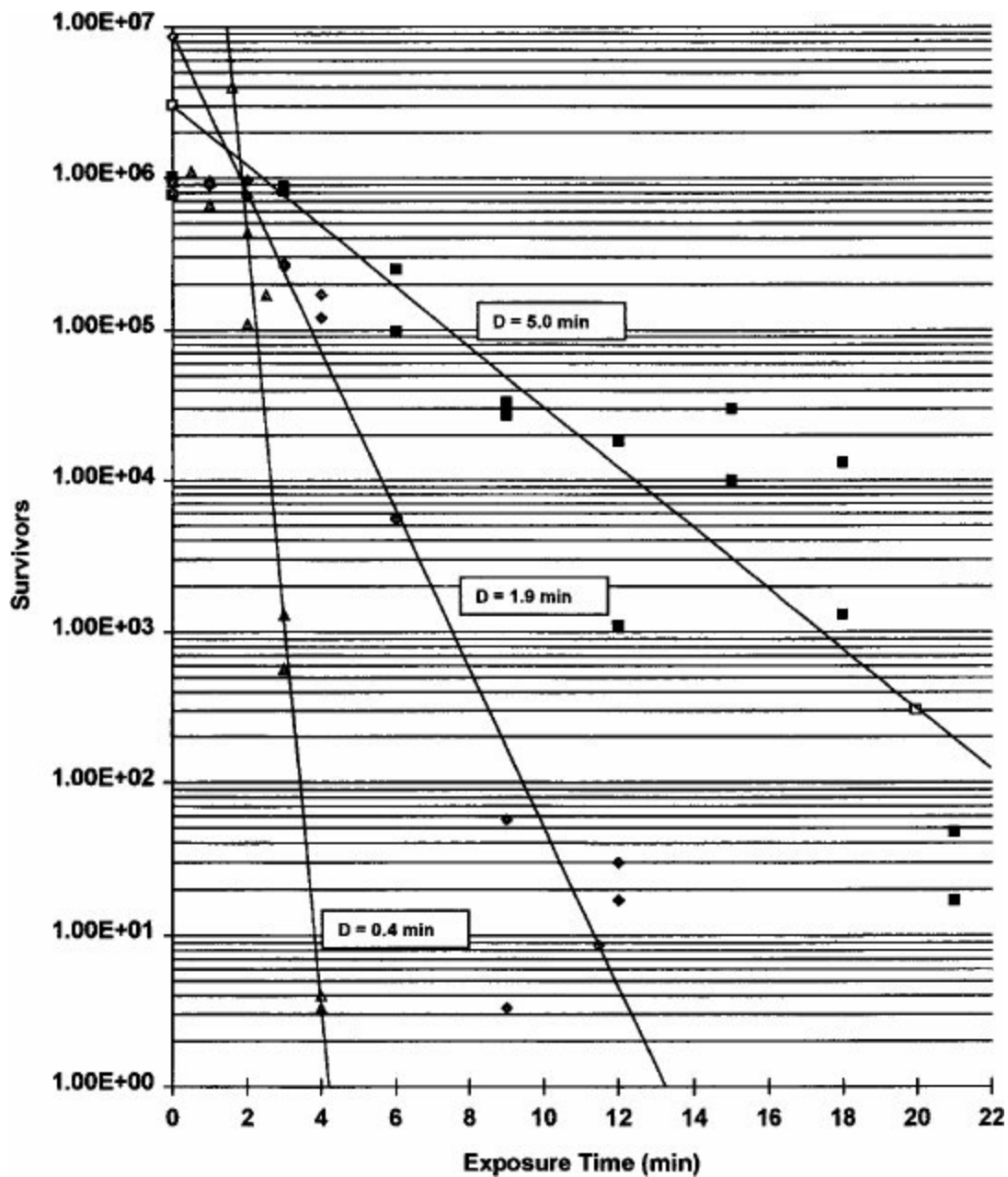

**Figure 2.** Survivor curves for *B. subtilis* exposed to 1 g/min (■), 2 g/min (◆), and 3 g/min (▲) at air flow rates of 14 cfm. These exposures correspond to approximately 624, 1248, and 1872 ppm of VHP, respectively. The D-values were obtained by linear regression analysis (open symbols) and represent the exposure time that results in a 1 logarithm decrease in survivors. Points within 0.5 logarithm of the positive control were omitted from regression analysis.

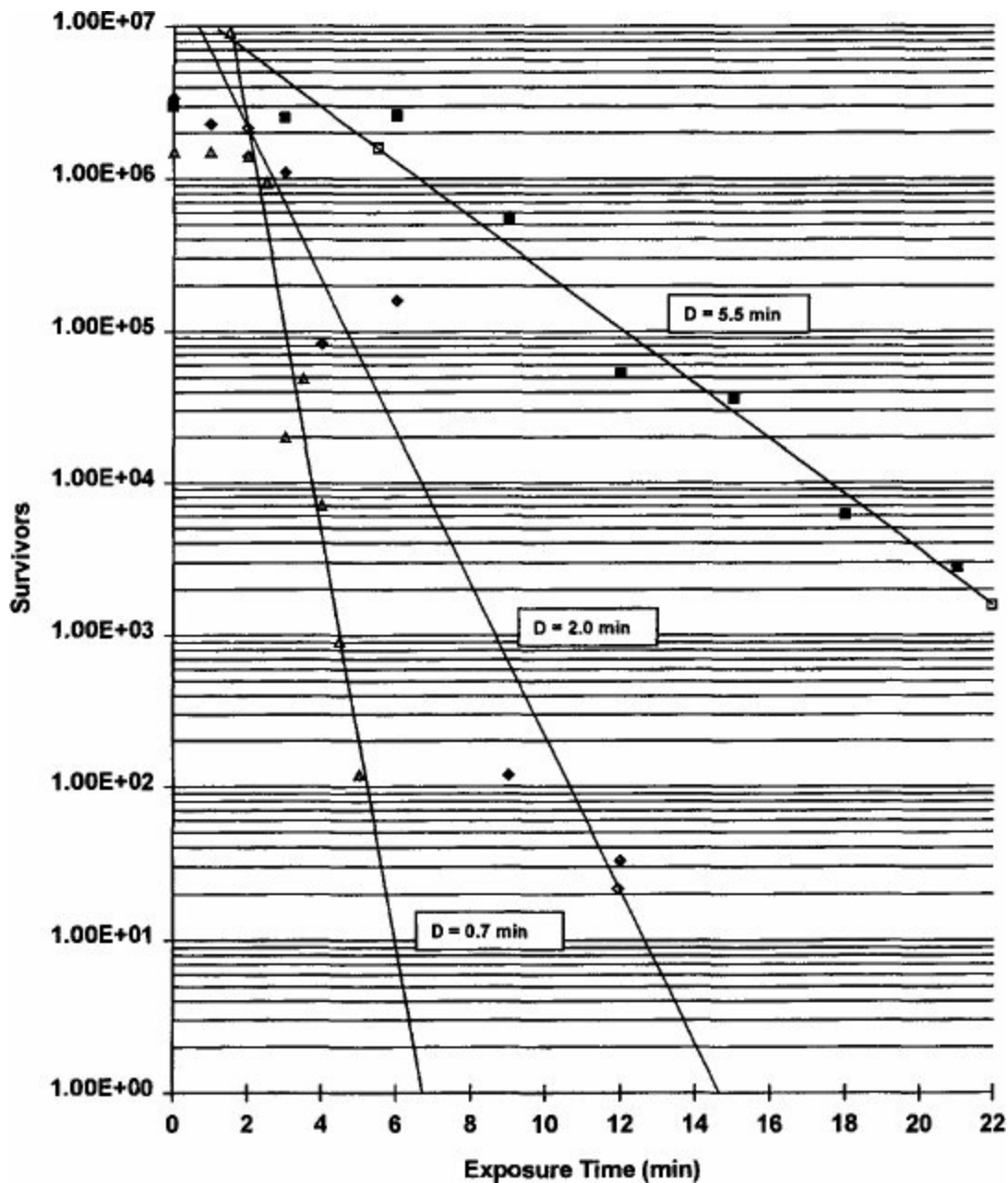

**Figure 3.** Survivor curves for *C. sporogenes* exposed to 1 g/min (■), 2 g/min (◆), and 3 g/min (▲) at air flow rates of 14 cfm. These exposures correspond to approximately 624, 1248, and 1872 ppm of VHP, respectively. The D-values were obtained by linear regression analysis (open symbols) and represent the exposure time that results in a 1 logarithmic decrease in survivors. Points within 0.5 logarithm of the positive control were omitted from regression analysis.

**Table 1. Comparison of the Resistance of Various VHP Biological Indicator Systems**

Indicator Type	# Positives / # Tested		
	Run 1	Run 2	Run 3
<i>B. stearothermophilus</i> (AMSCO Indicators)	0/38	1/38	1/38

(Bare Coupons)	2/38	0/38	0/38
<i>B. subtilis</i> (Polyethylene Pouch)	10/38	10/38	15/38
<i>C. sporogenes</i> (Polyethylene Pouch)	4/38	10/38	6/38

### *Effect of Prehumidification of VHP Biological Indicators on D-value Analysis*

Perhaps the most important influence on the VHP D-value is prehumidification of the biological indicators. A dramatic increase in VHP resistance was noted in the winter months when the relative humidity tends to be low. Since relative humidity is well known to influence resistance to dry heat and ethylene oxide, and more recently also chlorine dioxide [5], it was postulated that seasonal effect on VHP D-values was caused by variation in relative humidity. Humidity chambers were constructed by placing various saturated salt solutions into sealed jars and incubating them at 20 to 25°C. When the jars are maintained at a given temperature, the headspace will equilibrate at a defined relative humidity [4]. Figure 4 shows the effect of placing the biological indicators in the 8% (KOH) and 84% (KCl) humidity chambers and allowing them to equilibrate for at least 3 days prior to exposure to the VHP sterilization process. This incubation time takes into account the fact that the polyethylene envelope retards humidity equilibration. The VHP D-value is substantially higher when *B. subtilis* spores are prehumidified at 8% relative humidity (3.1 minutes) than when prehumidified at 84% relative humidity (0.9 minutes). The biological resistance to VHP appears to be nonlinear with respect to relative humidity (Figure 5). These results suggest that spore moisture content plays a key role in biological resistance to VHP as is also the case for chlorine dioxide [5].

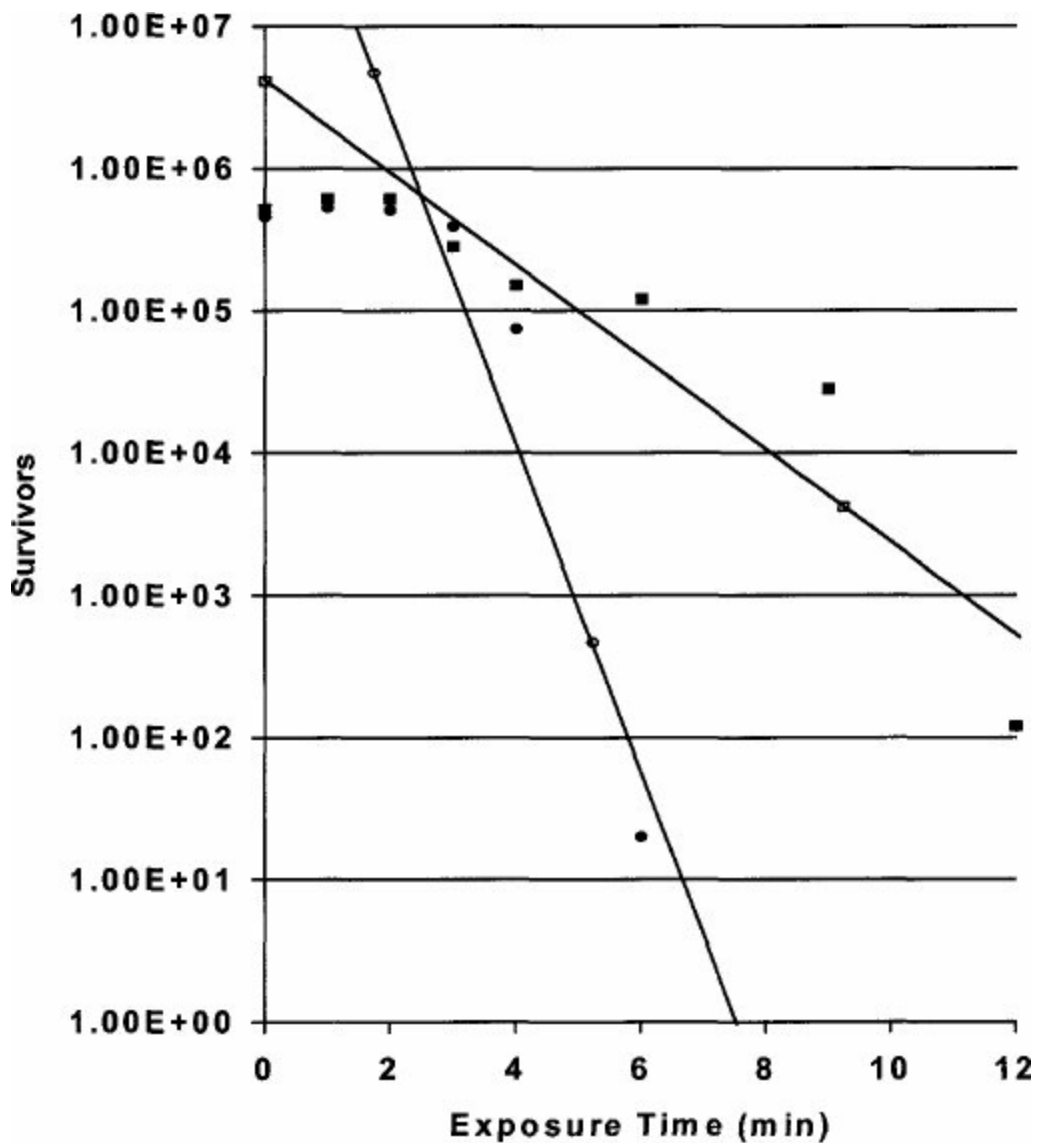

**Figure 4.** The effect of prehumidification on biological kill by VHP. Biological indicators were held in the 84% relative humidity chamber (●) or the 8% relative humidity (■) humidity jars for 3 days. The biological indicators were then exposed for various times using a 2 g/min injection rate and an airflow rate of 14 cfm. This corresponds to approximately 1248 ppm of VHP. The vessel chamber temperature was 30°C. The D-values were obtained by linear regression analysis (open symbols). The D-values were 0.9 and 3.1 minutes for prehumidification at 84% and 8% relative humidity, respectively.

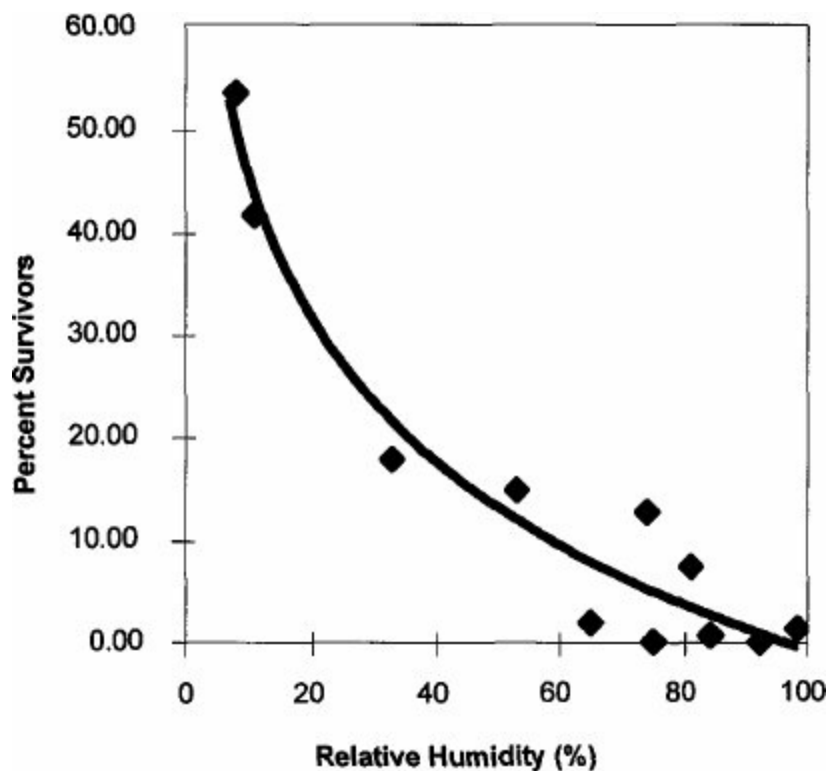

**Figure 5.** The effect of prehumidification on biological kill by VHP. Biological indicators were prehumidified at various humidity levels. The biological indicators were then exposed for 6 minutes using a 2 g/min injection rate and an airflow rate of 14 cfm. This corresponds to approximately 1248 ppm of VHP. The vessel chamber temperature was 30°C.

One possible explanation for the humidity effect is that hydrogen peroxide vapor forms a rapid equilibrium between the environment and the internal spore matrix. Dissolution of the vapor peroxide in the spore-bound water shifts the equilibrium unidirectionally in favor of the internal peroxide. In other words, the effective peroxide levels within the spore are increased as spore-bound water increases. Other explanations are equally plausible, but this hypothesis is favored due to the fact that it accounts for a similar phenomenon among a wide variety of gaseous sterilants despite differing mechanisms of kill. It seems likely that the polyethylene envelope would accentuate the impact of prehumidification on VHP sterilization because the envelope is known to retard the equilibration process. The degree to which relative humidity influences VHP resistance of exposed spores (i.e., unwrapped coupons) depends largely on the equilibration rate between the environment and the spore coat. For example, the VHP generator performs a dehumidification step prior to introducing the peroxide vapor. This dehumidification step would be expected to play a greater role in biological resistance than would any prehumidification of the spores if moisturization of the spores was not retarded by the polyethylene envelope. Likewise, the water introduced during the sterilization cycle would be expected to rapidly moisturize exposed spores. Comparison of the data in Tables 1 and 2 supports the notion that prehumidification has a greater effect on the biological indicators contained within a polyethylene envelope. Future experiments will be aimed at better understanding moisture equilibration rates and the effect of relative humidity on VHP resistance.

**Table 2. Comparison of the Resistance of Various VHP Biological Indicator Systems<sup>1</sup>**

Indicator Type	# Positives / # Tested		
	Run 1	Run 2	Run 3
<i>B. stearothermophilus</i> (AMSCO Indicators)	0/15	0/15	0/15
<i>B. stearothermophilus</i> (Bare Coupons)	0/15	0/15	0/15
<i>B. subtilis</i> (Polyethylene Pouch)	2/15	0/15	0/15
<i>C. sporogenes</i> (Polyethylene Pouch)	0/15	0/15	2/15

<sup>1</sup> The biological indicators were prehumidified for 3 days at 84% relative humidity prior to exposure.

### *Chemical Indicators for Detection of Hydrogen Peroxide Vapor*

A chemical indicator was developed to provide a simple, inexpensive, and quantifiable method to monitor the VHP sterilization process. It is based on using a standard colorimetric assay for detection of hydrogen peroxide (and other oxidizers) in liquid samples [7], except that the assay reagents are contained within the same polyethylene envelope used for the biological indicators. The indicators were placed in the BIER vessel and then exposed to different VHP concentrations for a range of exposure times. Figure 6 demonstrates the utility of this chemical indicator. The data demonstrate first order kinetics provided that exposure times are short (i.e., seconds). An average absorbance at 353 nm per gram of injected hydrogen peroxide was calculated by normalizing the data with respect to injection rate and time. This yielded a result of  $0.475 \pm 0.074$  absorbance units/g at 30°C. Increasing the BIER vessel chamber temperature to 60°C increased the average absorbance units per gram to 0.790 (data not shown). The rate of color development was not measurably different upon varying temperature. In addition, the temperature did not appear to influence the degree of color development. The final absorbance was identical for given concentrations of hydrogen peroxide over a broad temperature range. Thus, the most likely explanation for the temperature effect is that the polyethylene envelope is more permeable to VHP with increasing temperature.



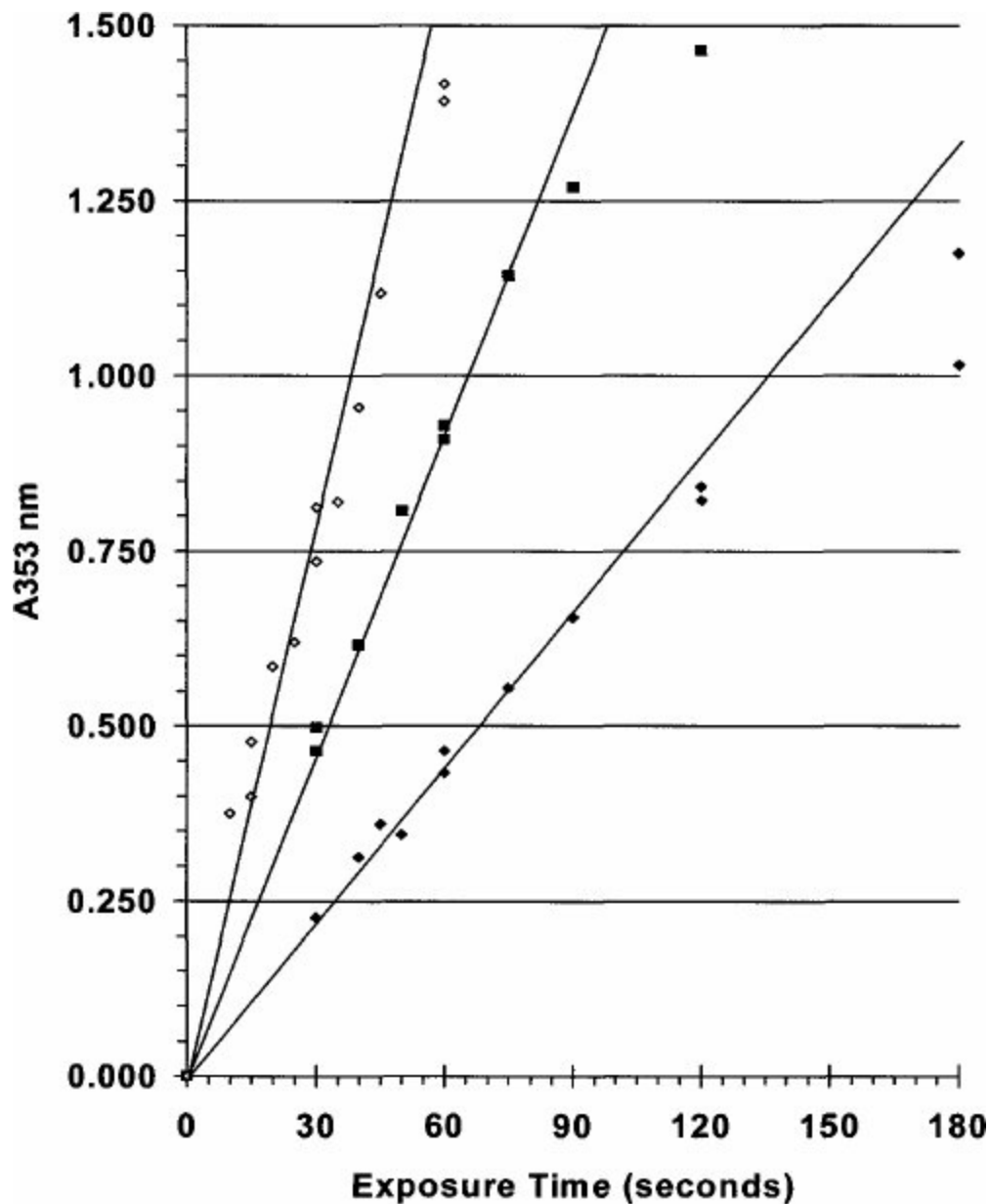

**Figure 6.** Chemical indicator detection of VHP at 1 g/min (♦), 2 g/min (■), and 3 g/min (●) at air flow rates of 14 cfm at 30°C. These exposures correspond to approximately 624, 1248, and 1872 ppm of VHP, respectively. Each data point represents an average from three test units. The data represents a composite from two different test dates. A liquid standard curve was performed for each test date to assure consistency between the different reagent mixtures.

These chemical indicators offer several advantages over current technology. First, VHP concentration can be finely mapped across locations within an enclosure. The use of AOTF-NIR detectors are somewhat limited in recessed areas. Second, other chemical indicators provide a yes or no answer regarding VHP exposure. Quantitative results can be obtained from the chemical indicators described in this study. Although quantitative, the chemical indicator is limited due to the use of liquid hydrogen peroxide standards. Use of gas standards should be feasible, but it has been technically challenging to create a stable gaseous peroxide standard. For this reason, the use of this chemical indicator system has been restricted to run-to-run or location-to-location comparisons. A relative number can,

however, be assigned despite this limitation. Third, the methodology should be applicable to any vaporous oxidizing agent including ozone, chlorine dioxide, formaldehyde, and peracetic acid.

### *VHP Cycle Development*

The BIER vessel enabled testing of both the biological and chemical indicators under conditions of square wave kinetics, whereby the plunger was used to insert and remove the indicators from the VHP stream. Moreover, the vessel itself quickly realized steady state VHP concentrations due to the combination of a small vessel size and a large air turnover (Figure 7). The VHP concentration, as detected by the AOTF-NIR, was found to be somewhat higher than the calculated steady state concentration. The cyclic nature of the peroxide concentration, particularly at lower injection rates, suggested that the VHP generator delivers peroxide in pulses rather than as a continuous stream. The pulses are likely exaggerated by the small vessel size. This may account for the increased variability observed in D-value data points as injection rate is reduced (Figures 2 and 3). The use of a scanning AOTF-NIR detector may also influence the degree of pulsation, particularly in a small vessel with high air turnover rates. The displayed peroxide level tends to represent an average of data over the scan time. Nonscanning AOTF-NIR instruments also average data, with nearly instantaneous data collection, but they are potentially less useful for problem solving (e.g., background and interference). Both types of AOTF-NIR instruments serve the purpose of monitoring VHP concentration and allow correlation to the response of the chemical and biological indicators.

The ability to continuously monitor VHP concentration and to measure the biological resistance to VHP led to development of a lethality model. This model includes the concepts of lethality tables,  $F_v$  (analogous to  $F_0$  in moist heat sterilizers [9]), and predicted spore logarithmic reduction. A lethality table can be constructed based on the following lethality equation:

$$L 10^{[(T - T_{ref})/z]}$$

where  $Z = 1138$  ppm

where  $T_{ref} = 1468$  ppm

where  $T =$  the measured VHP concentration.

The z-value was obtained from duplicate D-value analysis for the *B. subtilis* indicator organism at three different VHP concentrations (Figure 2). The reference VHP concentration ( $T_{ref}$ ) is the VHP concentration that yielded a 1.0 minute D-value for the biological indicator. While the model is not yet perfected, it clearly provides a classical approach for monitoring a new sterilization process.

Table 3 demonstrates a hypothetical VHP cycle. A predicted spore logarithmic reduction can be calculated based on using different z- and D-values. This allows the added flexibility of using the same lethality table for a variety of different microorganisms inoculated on various types of materials.

**Table 3. Predicted Spore Logarithmic Reduction (PSLR) For a Hypothetical VHP Sterilization Cycle Using Various D- and z-values**

Time	VHP (ppm)	Fv Physical	Fv z=1000	Fv z=2000	Fv z=3000
1	0	0.05	0.03	0.18	0.32
2	25	0.05	0.04	0.19	0.33
3	80	0.06	0.04	0.20	0.34
4	100	0.06	0.04	0.21	0.35
5	600	0.17	0.14	0.37	0.51
6	1000	0.39	0.34	0.58	0.70
7	1500	1.07	1.08	1.04	1.02
8	2100	3.59	4.29	2.07	1.62
9	2900	18.13	27.04	5.20	3.00
10	2500	8.07	10.76	3.28	2.21
11	2700	12.09	17.06	4.13	2.57
12	2400	6.59	8.55	2.92	2.04
13	2300	5.38	6.79	2.61	1.89
14	1800	1.96	2.15	1.47	1.29
15	900	0.32	0.27	0.52	0.65
16	600	0.17	0.14	0.37	0.51
17	150	0.07	0.05	0.22	0.36
18	50	0.06	0.04	0.20	0.34
19	25	0.05	0.04	0.19	0.33
20	0	0.05	0.03	0.18	0.32
<b>Totals</b>		<b>58.39</b>	<b>78.91</b>	<b>26.13</b>	<b>20.74</b>
	D = 0.5	116.79	157.82	52.25	41.48
	D = 1.0	58.39	78.91	26.13	20.74
	D = 2.0	29.20	39.45	13.06	10.37
	D = 5.0	11.68	15.78	5.23	4.15

# Summary

This paper describes the measurement of VHP resistance of spore-forming organisms and the incorporation of VHP detection systems into a classical approach to sterilization validation. These tools have laid the groundwork for investigating critical factors influencing biological resistance to VHP, including temperature, condensation, and material effects. They may also provide a means to investigate the mechanism by which VHP kills spores. While the literature does not generally address VHP resistance mechanisms, it is possible that the resistance mechanism is similar to that for liquid hydrogen peroxide, particularly if peroxide vapor dissolves in spore-bound water.

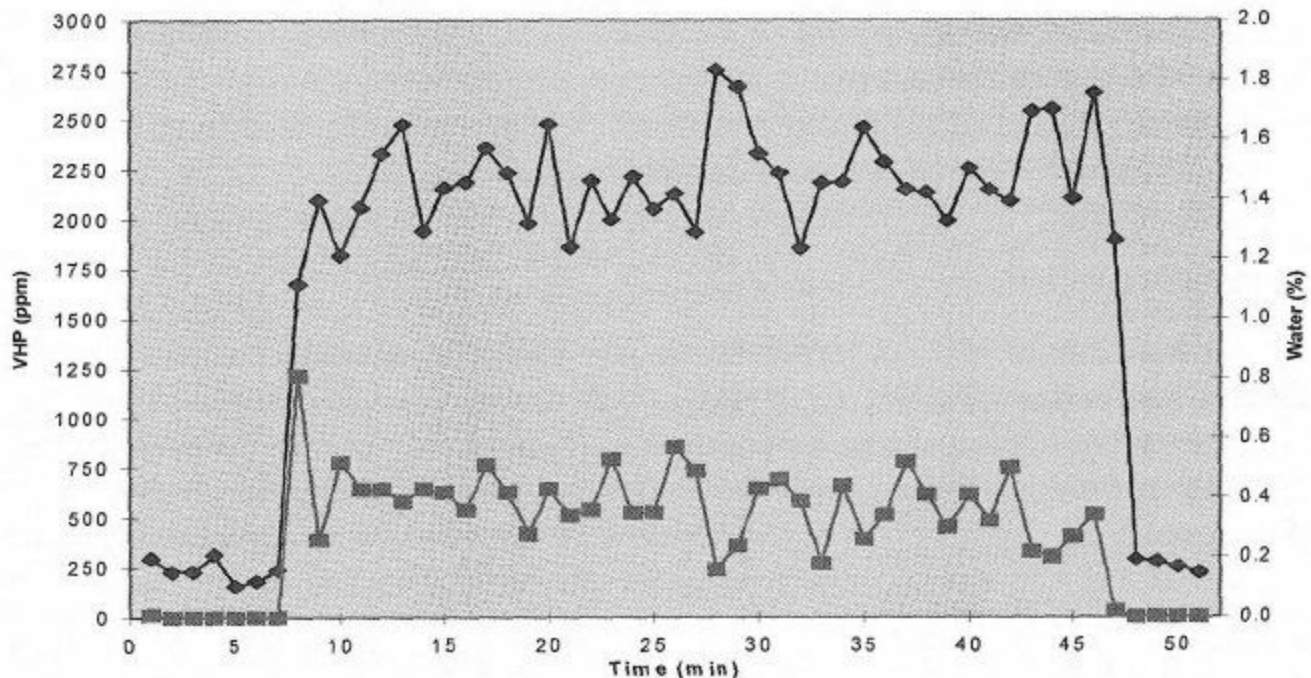

**Figure 7.** AOTF-NIR monitoring of a VHP BIER vessel sterilization cycle (2 g/min injection, airflow of 14 cfm) for VHP concentration (■) and percent water (◆). The detector cell was located in a separate housing placed on the exit side of the BIER vessel. The calculated steady state concentration for this cycle is approximately 1248 ppm.

Liquid hydrogen peroxide appears to decoat spores resulting in cortex lysis and subsequent degradation of the core [14]. Mutation of the *dacB* gene, which encodes an enzyme involved in spore cortex biosynthesis, results in a higher core water content than found in wildtype *B. subtilis* [10]. Interestingly, the *dacB* mutants are much less resistant to both heat and hydrogen peroxide. Reducing the core water content would likely limit free radical production [14] and would be expected to decrease the sporicidal effectiveness of hydrogen peroxide. DNA binding proteins, such as the  $\alpha/\beta$  small, acid-soluble proteins, protect spore DNA from oxidative damage [10,13]. When  $\alpha^- \beta^-$  mutants are exposed to hydrogen peroxide, the mutational frequency increases and the number of survivors decrease [10,13,14]. Although DNA damage does not appear to be a primary target of hydrogen peroxide in wildtype spores [13], it may be possible to overcome the protective effect of the  $\alpha/\beta$  proteins by increasing the degree of DNA hydration. In addition, critical

enzymes, such as glucose 6-phosphate dehydrogenase and aldolase, are oxidatively inactivated when spores are exposed to hydrogen peroxide [8]. It is conceivable that spore-bound water could influence the extent of enzyme inactivation, a hypothesis that can be tested by comparison of enzyme inactivation rates in wildtype and *dacB* mutants.

Future studies will be aimed at better understanding the role that humidity plays in VHP inactivation of spores. It will be particularly interesting to measure the biological inactivation rates of the  $DacB^-$  and  $\alpha^- \beta^-$  strains in the VHP BIER vessel. Testing the relative resistance of these strains when pretreated at different humidity levels would be the key in understanding the mechanistic differences between spore kill by VHP and by liquid hydrogen peroxide.

# Acknowledgments

The authors wish to acknowledge the valuable technical contributions of G. Rogers, P. Basdeckis, S. Junghare, and G. Curtis. We also thank R. Alexander for sharing the biological indicator comparison data from our collaborative efforts. In addition, the advice of T. Berger, A. Dudleston, and F. Bing is greatly appreciated. Thanks to M.S. Colón-López and D. Ostrow for critically reading the manuscript.

# References

1. Berger TB, May TB, Nelson PA, Rogers GB, Korczynski MS. The effect of closure processing on the microbial inactivation of biological indicators at the closure-container interface. *J Pharm Sci Technol* 1998;52:70.
2. Corveleyn S, Vandenbossche GMR, Remon JP. Near-Infra (NIR) monitoring of H<sub>2</sub>O<sub>2</sub> vapor concentration during hydrogen peroxide (VHP) sterilisation. *Pharm Res* 1997;14:294-8.
3. Crozier D, Lang G, Ananth S. On-line analysis of vapor hydrogen peroxide in isolation barrier technology. *Pharm Technol* 1996;Nov:62-72.
4. Dean JA. Solutions for maintaining constant humidity. In: Dean JA, editor. *Lange's Handbook of Chemistry*. 14th ed. New York: McGraw-Hill, Inc; 1992. p. 11.6.
5. Jeng DK, Woodworth AG. Chlorine dioxide gas sterilization under square-wave conditions. *Appl Environ Microbiol* 1990;56:514-9.
6. Klapes NA, Veseley D. Vapor-phase hydrogen peroxide as a surface decontaminant and sterilant. *Appl Environ Microbiol* 1990;56:503-6.
7. Ovenston TCJ, Rees WT. The spectrophotometric determination of small amounts of hydrogen peroxide in aqueous solutions. *Analyst* 1950;75:204-8.
8. Palop A, Rutherford GG, Marquis RE. Hydroperoxide inactivation of enzymes within spores of *Bacillus megaterium* ATCC 19213. *FEMS Lett* 1996;142:283-7.
9. Pflug, IJ. System for parameterizing survivor curves that are concave upward or concave downward. In: Pflug IJ, editor. *Microbiology and Engineering of Sterilization Processes*. 7th ed. Minneapolis: Environmental Sterilization Laboratories; 1990. p. 3.23-3.31.
10. Popham DL, Sengupta S, Setlow P. Heat, hydrogen peroxide, and UV resistance of *Bacillus subtilis* spores with increased water content and with or without major DNA-binding proteins. *Appl Environ Microbiol* 1995;61:3633-8.
11. Rickloff JR. The development of vapor phase hydrogen peroxide as a sterilization technology. In: *VHP™ Technology: A Collection of Scientific Papers*. 2nd ed. Apex: AMSCO; 1992. p. 1-13.
12. Rickloff JR. Use of vapor phase hydrogen peroxide (VPHP) for sterilization and decontamination applications. In: *VHP™ Technology: A Collection of Scientific Papers*. 2nd ed. Apex: AMSCO; 1992. p. 22-31.
13. Setlow B, Setlow P. Binding of small, acid-soluble spore proteins to DNA plays a significant role in the resistance of *Bacillus subtilis* spores to hydrogen peroxide. *Appl Environ Microbiol* 1993;59:3418-23.
14. Setlow P. Mechanisms for the prevention of damage to DNA in spores of *Bacillus* species. *Ann Rev Microbiol* 1995;49:29-54.
15. Todd TR, Cover LW. Hydrogen peroxide delivery rate vs. concentration. *J Pharm Processing* 1997;Nov:60-3.





# **Global Harmonization of Premarket Review of Sterilization Technology**

**Timothy A. Ulatowski, M.S.**

*Center for Devices and Radiological Health, Food and Drug Administration, U.S.A.*

# Introduction

The global harmonization of premarket procedures for medical devices is an immense challenge. Unnecessary differences in premarket regulatory procedures are an impediment to commerce, expending resources that could otherwise be spent on research and development or in cost savings to the consumer.

There are several causes for regulatory differences. First, the laws that govern medical devices vary from country to country. The laws need not be identical to foster harmonization, however, they at least need to be flexible, or be interpreted as liberally as possible to optimize the opportunity for harmonization.

Regulations are promulgated to implement laws, including those concerning premarket evaluation of medical devices. As with medical device law, if the corresponding regulations can be promulgated and interpreted to permit flexible, alternative regulatory approaches, then harmonization may be advanced.

Guidance developed by the regulatory authorities provides further interpretation of the laws and regulations. Guidance also provides more detail on specific procedures and recommendations for compiling and providing information to regulatory authorities. These documents may describe the form and content of premarket submissions to regulatory authorities or third parties acting as regulatory surrogates.

Harmonization of premarket processes related to sterilization technology, a segment of the harmonization effort, is no less challenging. Harmonization depends upon the partnership of standards setting organizations, manufacturers, regulators, researchers, and the community using medical devices. Working together, common approaches to the premarket analysis of new technologies can be developed.

This paper will explore the problems encountered with harmonization of premarket review of sterilization technology from a regulator's perspective and proposes a solution. Also discussed is the strategy for successful implementation of the solution and the impediments that have and will be encountered. Finally, the paper highlights the progress made towards the goal of harmonization.

# Problem Definition

In order to define the problem, consider the following example. A manufacturer devises a new sterilization technology. For purposes of this paper we will call it Product Z. For purposes of this example it is not essential to know the particular aspects of the technology except to note that it need not be one of the established processes, e.g., steam, heat, or ethylene oxide. It does not particularly matter where the sterilizer is manufactured, or tested, or first to be entered into the market. In this example, the manufacturer eventually wants to market the device in more than one country (or economic community such as the European Union).

There are several problems encountered by this manufacturer. First, he is faced with fundamentally different regulatory paradigms in order to be cleared to sell the product in different countries. In the United States and Japan, there are centralized systems of regulatory review while the European Union has a decentralized review process.

The application processes differ. In the United States new devices generally are cleared or approved by means of submission of premarket notifications to the Food and Drug Administration (FDA), also known as 510(k) applications, and premarket approval applications. The 510(k) applications are intended to demonstrate that the new device is substantially equivalent to a legally marketed device and does not require premarket approval. Premarket approval is required for entirely new devices. To date, new technology sterilizers have been cleared through 510(k) applications. In the European Union new devices subject to the directives in effect are afforded a C.E. mark, allowing the product to be marketed within the member states. The mechanisms for obtaining the C.E. mark vary depending on the type and class of device. New technology sterilizers fall within Class IIA.

The standards that are utilized in the countries may be different. Even if the standards that are utilized are the same, the standards may be interpreted in different ways or the processes for their utilization may be different.

In the United States, both regulatory and voluntary consensus standards are utilized. There are no United States regulatory standards that specifically apply to sterilization technology. FDA has relied upon both domestic and international voluntary consensus standards in the sterilization technology area to help define sterilizer technical requirements and appropriate verification and validation tests. The standards have been referenced in guidance documents and provide recommendations on the data and information needed to obtain market clearance. The standards usually referenced are standards created by the Association for the Advancement of Medical Instrumentation (AAMI), whether or not they are approved as national standards by the American National Standards Institute (ANSI), and standards adopted by the International Standards Organization (ISO). There are sterilization technology standards that are AAMI, AAMI/ANSI, and/or ISO standards.

On the other hand, in the European Union devices must meet applicable essential requirements. Standards that are created by their standards organization, CEN or CENELECT, are intended to meet specific essential requirements. If a device meets a CEN or CENELECT standard that was created to address an essential requirement, the device is then considered to have met the requirement. There are several European standards

applicable to sterilization technology.

The scientific paradigms of countries may differ with regards to sterilization technology. The concept of sterility assurance generally is a concept that is accepted internationally as an endpoint for sterilization processes. However, the level of assurance assigned to a particular type of device may not be consistent from one country to another. Such is the case for skin contacting devices. Other areas of difference of opinions on sterilization technology analysis include the analysis of various aspects of design and testing, such as sterilant characterization, cycle development, performance qualification, and validation.

Devices that are used to clean and decontaminate medical devices also have unique requirements and are subject to different degrees of regulatory analysis. The endpoints for cleaning and decontamination are not internationally consistent. For example, hot water washers are not considered appropriate for high level disinfection of medical devices in the United States, while their utilization for such purposes may be acceptable in other countries, or they may be unregulated.

# Solution to the Problems

One solution to the aforementioned problems is a globally harmonized premarket system for sterilization technology based on common regulatory and scientific criteria. Is this realistic in today's complex international regulatory environment? If one were to ask the question a few years ago, the answer would be that it was unlikely. More recently there has been great strides towards achieving this goal.

# The Strategy for Success

The strategy for meeting the goal of international harmonization includes many factors, four of which I believe are critical. They include:

- Selling the value of harmonization and neutralizing the cons
- Actively engaging affected parties
- Building confidence in scientific decision making
- Expanding success in increments

It is not self-apparent to everyone that harmonization has inherent value. The benefits must be described in terms that are relevant to the affected parties. There are resource savings that can be realized by elimination of redundant or different regulatory processes. These savings are not only incurred by the regulated industry but also by the regulators. Less time and personnel can be devoted to regulatory issues. The regulator can devote more time to issues with a higher degree of public health impact, such as critical new technologies. The manufacturer can devote more resources to research and development or other programs. Trade is enhanced if regulatory barriers to free trade are removed, such as the barriers of separate premarket clearance processes.

All affected parties must be engaged in the process of harmonization as early as possible to foster acceptance of the concept of harmonization and to create the necessary time to implement the changes in current procedures. Each affected party's concerns must be addressed. Complete satisfaction of the concerns may not be possible; compromise and optimization may be the best that can be achieved.

There is a pyramid of factors that must be considered in harmonization efforts. The laws and regulations are a foundation. As new procedures are developed, eventually concern regarding the underlying decision making comes into play. Common formats and content for submissions and common use of standards go a long way to achieve harmonization. Still, common interpretation and analysis of data and information is desirable so that the decisions that are rendered in one jurisdiction can be freely accepted in other jurisdictions. The European Union faced this issue with the decentralized system now in effect and community-wide acceptance of a C.E. mark assigned in one member state.

More often than not, significant strides in achieving standardization or other forms of harmonization are accomplished in small increments rather than quantum leaps. The activities related to harmonization can be segmented into a series of tasks that are accomplished in series or in parallel. Initial successes lead to confidence in the process of harmonization and sustain the willingness of those involved to go the distance.

# The Impediments

Impediments exist to the harmonization of premarket activities related to sterilization technology. Some of these impediments include:

- Cultural differences
- Nationalism
- The inertia of the legal systems
- Lack of trust between countries
- Experience in evaluation of sterilizer technology

The culture of a country or community has had a significant impact on its receptivity to harmonization. Some cultural aspects, which lead to different perspectives on harmonization, include risk tolerance, social proclivities regarding health care, and existing independence or interdependence of the society. A society that has a higher degree of risk tolerance, a desire to have a degree of regulatory control over the health care system, and interdependence within the society will be more amenable to harmonization. This is not to say that others will not accept harmonization, only that other factors become more important in the harmonization equation.

Nationalism can be a significant impediment to harmonization. In the European Union it has been a monumental task to overcome inherent nationalism to produce a system that relies on open economic borders within the community. Each country inherently desires to maintain its identity and a degree of control over their sovereignty and national interests. Accepting a harmonized process is viewed by some as surrendering a measure of independence.

Regulatory agencies have created bureaucracies that are often insensitive or unresponsive to the immediate needs of their customers. This has been recognized as a significant problem by the current executive administration in the United States. The Vice President of the United States has overseen a sweeping reengineering of many regulatory programs in order to address the issue of ineffective and intransigent government programs. The FDA itself has undergone significant change in order to adapt itself to the changing international environment.

Trust between partners is vital. While each party may have individual priorities and motives towards harmonization it is essential that there be no hidden agendas that may eventually undermine the process. The fundamental element of trust depends upon the desire of all parties engaged in the harmonization effort to be committed to optimizing processes which will help ensure the health and welfare of the public; other interests are secondary. Trust is built upon respect for the integrity and skill of all persons who are a party to harmonization. The sterilization technology area has helped foster trust between countries through international standards activities and scientific exchanges.

The experience of the regulatory authorities and conformity assessment bodies in evaluating new technology devices varies. New technology sterilizers may be introduced in predominantly one market; this does not enable development of expertise across countries in the evaluation of these new technologies. The 'class' of the device may not require

extensive conformity assessment in all countries, rather reliance on quality systems may be a more significant factor. While the regulatory authorities and conformity assessment bodies endeavour to bring to bear the highest degree of scientific expertise when assessing new products, a measure of expertise must be developed over time by evaluating the technology and associated scientific literature.



# Progress

Progress is being made in the global harmonization of premarket evaluation of sterilization technology. Some factors at work include:

- The Food and Drug Administration Modernization Act
- Activities of the Global Harmonization Task Force
- Memoranda of Understanding and Mutual Recognition Agreements
- Exchange of product evaluation personnel
- International consensus standards activities

The Food and Drug Administration Modernization Act of 1997 (FDAMA) included a number of new statutory requirements concerning premarket activities. One of these requirements is Section 410, Mutual Recognition Agreements and Global Harmonization. This section provides that FDA will support harmonization activities as a means to reduce regulatory burdens and to harmonize regulatory requirements.

FDA had been engaged in harmonization activities when FDAMA was being crafted. It was apparent to Congress that the harmonization efforts already underway could be strengthened by statutory mandate. While the statute does not dictate specific activities, it is clear that the agency must remain proactive in harmonization activities to be consonant with the spirit and letter of the law. This section of the law fosters harmonization of assessment of sterilization technology.

Another significant part of FDAMA is Section 204, which pertains to the recognition consensus standards. Section 204 states, in part, that FDA “shall by publication in the Federal Register, recognize all or part of an appropriate standard established by a nationally or internationally recognized standard development organization for which a person may submit a declaration of conformity in order to meet a premarket requirement....” This section of FDAMA, coupled to the reengineered FDA standards and 510(k) program, will have significant impact on premarket assessment of sterilization technology and foster premarket harmonization.

First, Section 204 enables the use of consensus standards that will be recognized by FDA in a manner similar to the European Union and Canada as well as other countries that basically follow the same form of utilization of standards. Manufacturers who declare the use of recognized standards in premarket submissions would derive benefit from a reduced need for premarket documentation in submissions to FDA. International and domestic sterilization standards are one example of types of standards that are eligible for recognition. If essentially the same standards are recognized by the United States and adopted by Canada and the European Union, then design and testing aspects for sterilization technology will be harmonized. The evaluation of data and information per a standard by a regulatory authority or conformity assessment body will be subject to variation.

Next, the new standards process in FDA is more coordinated and directed towards harmonization activities, particularly with regard to sterilization technology. FDA is fully engaged in the sterilization standards process, both domestically and internationally.

Resources are being prioritized for many of the sterilization standards activities.

Lastly, the new 510(k) paradigm provides an alternative method for product submissions that utilize declarations to recognized standards. The 'abbreviated' 510(k) process is intended as a method to accelerate premarket evaluation and to encourage the design and development of devices that are state of the art per current standards, rather than simply equivalent to legally marketed devices. The paradigm also includes an expedited way to process changes to marketed products. Both of these processes enable the agency to utilize harmonized standards, including sterilization standards, in a manner that benefits new product development and change.

In the Federal Register, Volume 63, Number 37, dated Wednesday, February 25, 1998, FDA published a notice announcing the availability of guidance entitled "Guidance on the Recognition and Use of Consensus Standards." The purpose is (1) to provide guidance to industry and FDA personnel on the use of standards that are recognized by FDA in accordance with Section 204 of FDAMA, during the evaluation of premarket submissions; (2) to publish the initial list of recognized standards; and (3) to announce the policy on updating the list of recognized standards.

The list of recognized standards is also available on the FDA Internet site ([www.fda.gov/cdrh](http://www.fda.gov/cdrh)). Along with this list are supplementary information sheets for each standard. The supplementary data sheets include information of interest such as where to obtain a copy of the standard, who to contact at FDA with questions regarding the standards, and what devices are impacted by the standard.

A manufacturer may elect to declare conformity to a recognized standard that is relevant to the design and testing of their device. The declaration will reduce the information that should be provided to FDA to support a marketing application. The manufacturer may meet a standard in whole or in part but the declaration must provide details on the aspects of the standard that are met.

There are several domestic and international sterilization standards that a manufacturer may elect to use when designing or testing their device. FDA will recognize a number of these standards. The process for recognition will be the same for sterilization standards as for other standards. FDA personnel with experience and training in sterilization technology, including the FDA liaison to the standard committee for the standard being considered, if any, will consider the merits of the standard and determine whether the standard should be recognized, in whole or in part. The supplementary sheet for each standard will indicate whether the standard is recognized in total or partially. After management review, the final list of recognized standards will be published.

The activities of the Global Harmonization Task Force (GHTF) will impact sterilization technology. The purpose of the GHTF is to encourage convergence at the global level in the evolution of regulatory systems for medical devices in order to facilitate trade while preserving the right of the participating members to address the protection of public health by regulatory means considered to be most suitable. The GHTF consists of public authorities and regulated industry from the regions of Europe, North America, and Asia/Western Pacific with additional observers. The GHTF has an executive group and four study groups developing guidance and documents related to premarket, quality systems,

vigilance, and auditing.

One of the activities of Study Group 1, Premarket, is the development of a harmonized technical file which will serve as a common format for collection and submission of technical information to regulatory authorities or authorized third parties. Manufacturers of sterilization technology that is marketed in several different countries could use this format. The concept is that it will help to standardize the documentation from one country to another. The GHTF will test the common format for a technical file by its use in some pilot evaluations.

The GHTF has made inroads on common premarket technical requirements beyond those concerning format as discussed above. The specific technical requirements for medical devices are different from one country to another. The GHTF is identifying where there are divergences and will then attempt to minimize the differences.

The activities of the GHTF are having a profound influence on the activities related to regulation development for medical devices in many countries. New legislation is being considered in many Pacific Rim countries. As these regulations are drafted, the GHTF receives copies and analyzes the regulations looking for suggestions for change which will make the regulations in line with emerging GHTF common premarket or postmarket activities. The GHTF sends comments to the country with recommended changes that harmonize the new regulations to GHTF systems.

The United States and other countries have been engaged in the development of memoranda of understanding (MOUs) or mutual recognition agreements (MRAs). These bilateral or trilateral agreements between countries seek to develop uniform methods of premarket and postmarket regulatory oversight. The activities addressed by these MOUs and MRAs may have some impact on new technology in the sterilization area with regard to the evaluation of sterilization processes for products affected by the MOUs and MRAs.

An MRA with Europe identifies several products, including some sterilization technology, which will be subject to third party review. European evaluators will review 510(k)s, while third parties in the United States will serve as notified bodies. FDA will have final review authority for premarket evaluations.

In order to foster the confidence building effort between countries there is an active exchange of personnel in different product review areas. These personnel learn the process of the other country and contribute their expertise and knowledge to product evaluation while seeing first hand the review process of the other country. Currently, Canada, Australia, and the United States have participated in employee exchanges.

One of the most significant areas to impact sterilization technology will be the standards development process. As discussed above, FDA is using standards to evaluate products and is currently in the process of recognizing several sterilization standards.

The process of development of sterilization standards through a consensus process must be nurtured. FDA and the industry must remain active partners in the development of standards that are relevant in order to accomplish this. The process must include all parties with a stake in the outcome.

Additional effort must be devoted to the development of standards for devices and processes not yet covered, as well as the development of technical information documents and guidance on product specific and cross cutting issues.

In sum, international variations in medical device statutes, regulations, and procedures create a complex challenge for the medical device manufacturer. Despite these differences global harmonization activities are proceeding that will simplify the international regulatory environment. The savings incurred will benefit all parties involved.



# Discussion

## Emerging Sterilization Issues & Technologies

**Question for Prof. Tallentire, Air Dispersions Ltd., U.K.:** On the proposed method of substantiation of 25 kGy, have you performed the computer simulation assessment with the various populations of resistant distributions similar to those you presented for Method 1 and Method TR? What were the results?

**Answer by Prof. Tallentire:** The answer to this question is not available at this stage. This is work that we will be doing in the very near future.

**Question for Prof. Tallentire:** What level of  $D_{10}$  and frequency of occurrence will be needed to fail the  $VD_{max}$  test?

**Answer by Prof. Tallentire:** These will clearly come out of computer evaluations but I don't anticipate that they're going to be very much different from what we've seen with Method 1. We would certainly not expect to see any more unsafe outcomes from the evaluations and we would expect to see fewer of the false failures with respect to the suggested method.

**Question for Prof. Tallentire:** Have you performed testing with products that require a dose in excess of 25 kGy via Method 1 and Method 2 to determine that the product failed to pass the  $VD_{max}$  test?

**Answer by Prof. Tallentire:** The answer to that is no but perhaps Dr. Kowalski might provide additional information.

**Comment by Dr. Kowalski, Johnson & Johnson, U.S.A.:** There are some studies in progress but we currently don't have any results. Since we have access to a gamma cell, one approach was to create a biological indicator system that you know should fail at 25 kGy and pass at 35 kGy, and challenge it with doses derived from the three methods. These types of studies will also be in progress. I should point out an interesting consequence of looking at deriving maximum verification doses — there is nothing unique about 25 kGy. If you run the same calculations, you can have a  $VD_{max}$  mentality for 30 kGy. What's very interesting is that there is again a bioburden rollover point where you have to change your linear assumption to the  $TD_{10}$  assumption. It's very interesting if you run the Max calculations for a 30 kGy process and you want to uniquely qualify the ability of a product to meet  $10^{-6}$  at 30 kGy, the bioburden rollover point moves up a log to 500. If you do the calculations for a 20 kGy  $10^{-6}$  relationship, the bioburden rollover point goes down to approximately 5. Thus, there are some underlying mathematics of the SDR, the

consequence of which is if you move the sterilizing dose 5 kGy either up or down, the transition from linear to TD<sub>10</sub> occurs approximately in a 10-fold change in bioburden.

**Question for Dr. Halls, Glaxo Holdings PLC, U.K.:** Given the variability in biological indicators, why shouldn't we validate the process, monitor parameters, and then release parametrically? Should regulators accept parametric release more readily?

**Answer by Dr. Halls:** I would never use a biological system if I could find a physical or chemical alternative. At no point in my presentation did I consider or mention the routine use of biological indicators for controlling sterilizers but only as a validation or revalidation exercise. I'm strongly in support of parametric release for products and, indeed, for internal processes such as the sterilization of materials for aseptic manufacture which happens in the pharmaceutical industry all the time. We would never do a sterility test on filters, plugs, and other items that we sterilize for aseptic manufacture.

**Question for Dr. Halls:** If bio-revalidation is viewed as a confirmatory exercise and you adjust your process parameters to 'pass' the test, what exactly are you confirming?

**Answer by Dr. Halls:** I'm not suggesting that the process parameters are adjusted to allow you to pass the test but that the test system is standardized such that it measures at the same level of sensitivity each time.

**Question for Dr. Halls:** I understand the role of biological indicators for revalidation only. Nevertheless, if your test organism is drifting by a factor of 3, are you not led to reassess what you think is happening to the thermal resistance of the rest of the microbial world?

**Answer by Dr. Halls:** Yes, I think you're right. As a peripheral indicator of this, we run an ongoing low-key program to determine the thermal resistance of environmental and product isolates in the factory. We've been running this program for two decades. We've never found any spore former which has a D-value higher than the range of 0.8 to 1.2 minutes. This has been clearly constant for over two decades. The fundamental investigation of the system I think perhaps needs to be done and perhaps needs to be done by the people who are specialists in this arena. I'm a customer rather than an investigator of this area and I'm trying to propose something which will get us through the problem.

**Question for Dr. May, Abbott Laboratories, U.S.A.:** *Bacillus stearothermophilus* has previously been shown to be the most appropriate, i.e., the most resistant, challenge to the vapor phase hydrogen peroxide process. Why did you choose *Bacillus subtilis* as your primary challenge organism?

**Answer by Dr. May:** I primarily used *B. subtilis* because it's a spore former that we use. I am not suggesting that either *B. subtilis* or *B. stearothermophilus* should have priority over the other. I think the important thing is that you understand the resistance of your bioburden to the process and I am currently in the process of trying to figure that out. It so happens that the published reports on stainless steel coupons without any polyethylene

overwrap have about the same D-value and approximately the same concentration as what I found for the *B. subtilis* system. Thus, I really think it's understanding the relative resistance to your bioburden.

**Question for Dr. Kowalski:** Is there a role for chlorine dioxide technology for decontaminating biological safety cabinets in laboratory spaces and isolators?

**Answer by Dr. Kowalski:** Chlorine dioxide is applicable in situations that can be adequately sealed so there is no egress of the agent into the surrounding environment. The other driving force is fundamental materials compatibility. It would seem that biological safety cabinets which are generally stainless steel and glass should be compatible. You would have to look at the details of seals and other smaller details inside those cabinets. With respect to other spaces and isolators, I think the same comment holds. We have demonstration projects which are actually traversing the range of 25 cubic feet in a sterility testing isolator and some rooms that are approaching 5,000 cubic feet; again, the criteria are adequate integrity so the chlorine dioxide can be contained. Of course, as the volume grows, proper circulation and distribution must also be addressed in detail.

**Question for Dr. Kowalski:** What is 1 mg/L in parts per million (PPM) and when will the isolator generator be commercialized?

**Answer by Dr. Kowalski:** One mg/L equals 357 PPM. I think I can fairly say that the isolator generator will be commercialized during the next year.

**Question for Dr. Kowalski:** Do you have any data on fungal spore inactivation?

**Answer by Dr. Kowalski:** *Aspergillus niger* has been tested and it is not unusually resistant to chlorine dioxide sterilization. It's in the range, I believe, of *B. subtilis*.

**Question for Dr. Kowalski:** Do you have any inactivation data, (i.e., compatibility data), on PVC, stainless steel, elastomers, or glass or inactivation data of organisms on those materials?

**Answer by Dr. Kowalski:** Stainless steel has been tested and it runs parallel with other substrates. We have also deposited spores on flexible PVC and glass and they behave almost exactly the same. The bottom line is that we have not found a substrate that differs with any significance at all in the microbiological testing although, as I said, if you put a glassine wrapper around the substrate and imbed it in an intraocular lens case, you can affect the overall inactivation kinetics.

**Question for Mr. Ulatowski, Food and Drug Administration, U.S.A.:** Aren't the rigid imposition of standards sometimes contrary to the advancement of science and public health and how flexible will FDA be?

**Answer by Mr. Ulatowski:** Well, that's an interesting question. There is flexibility in the way that FDA intends to use standards as one option for marketing products. One means



to reduce the regulatory time is to file data submissions for those products where recognized standards apply. But if one moves down the path of a new technology, there remains the opportunity to submit premarket applications as in the past. There is one point that needs to be made. As FDA reviews new technologies and reviews traditional technologies, if I can use that term, we have to be very sensitive to the potential that in our decision-making we're not altering the fundamental science and engineering with regard to sterilization technology, and that we are not creating inappropriate paths for technology that are not well grounded in science. We are going to entertain new technology and we will move them forward, but we have to keep an eye on what we're doing in the agency to make sure we are well grounded as we move forward.

**Comment by Dr. Hoxey, Medical Devices Agency, U.K.:** If I could add the European perspective that the role of standards in the European regulatory system is pretty well established. Where standards are harmonized and recognized as such they give a presumption of conformance with the legal requirements but they are not mandatory. Thus the manufacturer has the option of using something other than the standards, but if they follow the standards, they are presumed to meet the regulatory requirements. This allows some flexibility but does give a strong incentive to use the Consensus standards which have been developed.

**Question for Prof. Tallentire:** How does fluctuation in bioburden affect the outcome of the dose determination with the revised method?

**Answer by Prof. Tallentire:** I think that the question is referring to the fact that when Method 2 was computer evaluated, built into that evaluation were variations in bioburden on different product items around an average value for the bioburden. In the computer evaluations that we've done, we have in fact assumed that the value of bioburden is exact. Obviously in time we will be looking to see what the effect of fluctuations of variations of bioburden will have. That really is a computer simulation rather than a computer evaluation.

**Question for Prof. Tallentire:** Could you comment on sample size for your new method and confidence limits with lower sample sizes? What is the impact to the revised method where the sample size of the verification dose experiments is reduced?

**Answer by Prof. Tallentire:** With respect to the sample size and what the confidence limits are, the answer is that again we have not yet done that. We will have to do that to find out the degree of risk associated with variations in sample size. Obviously, the smaller the sample size, the greater the risk that you will have to accept.

**Question for Dr. Halls:** Do you have any experience of how  $D_{121}$  values are affected by the material that the spores are absorbed onto, the substrate effect?

**Answer by Dr. Halls:** We've done some recent work with rubber plugs, glass, and stainless steel and we've found that the D-values tend to be increased, but rarely by more than 50% above the D-values obtained in water as a reference point. We also did a fair

amount of work recently with *B. stearothermophilus* spores in aqueous pharmaceutical products and in all cases, except one, we found that the sensitivity of the spore to heat was increased. In other words, the D-value was diminished considerably.

**Question for Dr. Halls:** I don't understand the species fixation industry has developed in moist heat validation. Why should we consider *B. stearothermophilus* sacrosanct? The principal criteria it would seem should be resistance to D-value, not species.

**Answer by Dr. Halls:** Well, the whole of industry is not fixated on *B. stearothermophilus*. Two leading large-volume parenteral manufacturers certainly do not use *B. stearothermophilus* in their biovalidations and revalidations. They use other microorganisms. *B. stearothermophilus* is recommended in the USP in a general information chapter. It has become to be very widely used in the small-volume parenteral industry. Thus, it's not a total fixation, but probably comes out of USP which is generally a pretty good way of achieving compliance if you have to comply with CDER inspections.

I agree with the questioner completely that the principal criteria should be resistance, not species. I do have a vague recollection, however, of seeing a listing about what a biological indicator should be. There are various criteria. For example, a biological indicator should be nonpathogenic. It should be distinctive in culture. It should be resistant to the treatment you are applying it to, not necessarily the most resistant type you can find available but resistant and should have a known consistent resistance. *B. stearothermophilus* does have another added advantage of growth at 55° to 60°C which virtually prevents confusion with other microorganisms and makes it a pretty clean test.

**Question for Dr. Halls:** What does the ability to kill a  $10^6$  population have to do with the sterility assurance level at  $10^{-6}$ ?

**Answer by Dr. Halls:** Absolutely nothing at all except if you can calibrate that to the bioburden and resistance that you are likely to find on your product when subject to natural environmental contamination. But this confusion, I think, does still exist, certainly in the small-volume parenteral pharmaceutical industry. And certainly in the evidence I see of massive systems, such as sterilized in-place systems, having biovalidation criteria set for them which merely says that you should kill  $10^6$  spores of *B. stearothermophilus*.

**Question for Dr. May:** Do you have any D-value data comparing *B. subtilis* to *B. stearothermophilus* on a standard scale?

**Answer by Dr. May:** I've not directly compared D-values of *B. subtilis* and *B. stearothermophilus* in the BIER vessels. I showed some data which suggest that the resistance of *B. stearothermophilus* is slightly less than *B. subtilis*, at least when it's wrapped in the polyethylene envelope.

**Question for Dr. May:** What temperature was used for the D-value studies?

**Answer by Dr. May:** Those D-values were performed at 30°C. As many of you who

may use VHP™ know, the process tends to heat the system up, so I also have a way of controlling that temperature and I've been using 30°C.

**Question for Dr. May:** If VHP has poor penetration ability, what sterilization application do you see it being used for?

**Answer by Dr. May:** In terms of its sterilization application, VHP is really a surface sterilant — a surface sanitizer — so I think it shares many of the same applications that Dr. Kowalski spoke of. There is certainly an application for isolators in terms of sanitizing walls and exposed surfaces. It's been used to decontaminate things such as centrifuges when they contain biohazardous waste, as well as laminar flow hoods when you have infectious agents. The main thing again with VHP is you just have to recognize its poor penetrating power and take that into account and decide if that application is appropriate for what you're trying to achieve.

**Question for Dr. Kowalski:** With regards to parametric release of chlorine dioxide sterilized products, what other critical sterilization parameters are in process and how have they been shown to be the critical parameters?

**Answer by Dr. Kowalski:** With respect to parametric release, knowledge and maintenance of gas concentration has the biggest effect upon the efficacy of the process. One of the characteristics of chlorine dioxide is the very easy measurement of the gas concentration all the way through charge, exposure, and exhaust. Chlorine dioxide does not seem to be very sensitive to temperature. We do control the sterilizer, however, between 30 and 32°C to be just enough above room temperature to exercise control so that sterilizer temperature is under control. The other parameter is relative humidity. The lower limit of relative humidity for chlorine dioxide efficacy is 55%. However, we generally control the process at between 70 and 80% relative humidity. If you use a dynamic environmental conditioning system inside the sterilizer and have well-calibrated pressure sensors, achievement of this relative humidity is very easy. Thus, I think the three things you want to look at are concentration, temperature, and relative humidity — all of which are easily measured — and I think you have the appropriate monitoring and control to have parametric release with chlorine dioxide.

**Question for Dr. Kowalski:** You reported testing more than fifty plastics for changes in materials properties. Did you consider a possible change in biocompatibility of these plastics?

**Answer by Dr. Kowalski:** Yes, possible changes in biocompatibility are clearly an issue. When we are in the isolation technology domain, biocompatibility is much less of an issue but, obviously, in the intraocular lens project that was a very key issue. Because this involved an implant in the eye, a complete appropriate battery of biocompatibility tests were done and they were acceptable. Of course, you would have to do this on a material-by-material and site-by-site basis and we'll perform these tests as we encounter them.

**Question for Dr. Kowalski:** Does chlorine dioxide inactivate hepatitis B and C and HIV as rapidly as other infectious agents?

**Answer by Dr. Kowalski:** I don't know. I have no knowledge that hepatitis B and C and HIV are any more resistant than polio virus and herpes virus and, under that broad assumption, I would assume that they would be readily inactivated by chlorine dioxide.

**Comment by Dr. Michael Scholla, DuPont Company, U.S.A.:** I would like to comment on Mr. Ulatowski's presentation in the area of standards based upon the FDA reform legislation. My comment is based on my role as chairman of the HIMA Standards Task Group which has been charged with developing HIMA strategy for dealing with the consensus standards process and will be presented to HIMA at its annual meeting. The HIMA Standards Task Group has met with the agency on several occasions and assisted in the development of a list of frequently asked questions which appear on the FDA Web Site to help explain this component of the new legislation. I have to personally say that I don't think most of the device manufacturers in the room truly recognize the impact of this part of the legislation on how we go about doing our business.

Let me ask a rhetorical question. How many of you have ever considered actually submitting a single page 510(k) to the FDA? Because, that's what this in fact will enable us to do. Let me explain this briefly. When a standard is published by the agency on the recognized list, this standard becomes the official FDA guidance that product reviewers must use in evaluating applications unless the applicant specifically asks that it not be considered against the standard. If the reviewer chooses to ignore the standard which has been published, they need director-level approval to ignore it. So, there is 'true teeth' in this policy. It's entirely possible that in the future, a 510(k) submission will simply state that, "The device complies with..." and lists the series of applicable standards and that the product labeling is attached. I have read a lot of 510(k) applications from the public domain and have never seen one that was one-page long and was subsequently approved. This really is a true paradigm shift, both for the agency and the industry, and we have to understand that such a great paradigm shift within the agency creates uneasiness as many of us have experienced in our companies as we've re-engineered ourselves over the last few years. We also need to take a role in helping this shift occur and be patient as this shift does occur.

**Comment by Mr. Ulatowski:** I would like to make a comment with regards to conformity to standards. One concern that we've already seen, and people will need to pay attention to, is that there are 'teeth' in this conformity business. There are penalties, fines, and such which will be imposed if a company makes a false declaration. In several submissions, I think people have made light of attentiveness to the standards. If you are declaring to the standard without deviation, you meet that standard without deviation. And, what we've seen before the conformities came into effect were such declarations or certifications. Once we investigated the data, however, there were deviations and novel ideas interspersed within the execution of the standard in the data. Thus, people really have to pay attention to the nature of the word and letter of the standard and to using the

standard as stated. If you do make a deviation or have a deviation, state it up front and justify your deviation.



# General Discussion

**Moderator:** **Joshua Lederberg, Ph.D.**  
*The Rockefeller University, U.S.A.*





# General Discussion

**Comment by Dr. Martin Favero, Advanced Sterilization Products, U.S.A.:** I would like to very briefly revisit the discussion on prions. There were some questions regarding the application of some of the inactivation data to the procedures that are used in hospitals. First, I would like to make a comment; second, give a very brief synopsis of the CDC guidelines which are in draft form; and third, make a suggestion to the prion and sterilization communities. In drafting guidelines on what to do with an instrument that had been exposed to a person with prion disease, it became clear that the recommendations that had been made historically have the same type of creep that we've seen with biological indicators. Further, the studies that involve this science are primarily based on those targeted to blood products and rendering systems, and the extrapolation of those data to the hospital environment, in the minds of many, is not justified.

Let me refer to some data that were shown. If all of the cases involving growth hormone, dura mater, and corneal transplants are eliminated, what is left consists of cases in which instruments that had been placed into the brain of an infected patient transmitted the infection to other patients. One such instrument is depth electrodes. If one considers the tangled wires going into the brain of an individual taken out, sterilized, and put into the brain of additional patients, there is a clear opportunity to transmit infection. In this procedure, the wires were soaked in quaternary ammonium solution and wiped off with cotton soaked in alcohol; this is malpractice in this country. In your mind's eye, you can actually see bits of tissue being transmitted from one patient to another.

The other example concerned a needle that went into the brain of a patient, was sterilized, and then caused infection in another patient. When it was sent to the NIH, prions were detected. This is an instrument that notoriously, because it has a very narrow lumen, cannot be cleaned or sterilized, and would qualify as an instrument that should be discarded. The other observation we made is that there are clearly tissues having high prion burdens and other tissues that have very little to no burden. I would submit that there is a difference between that needle and a flexible fiber endoscope. In one case, the instrument picks up a high prion burden which is then transferred into a very sensitive tissue region. In the other case, the instrument is probably exposed to very low prion burden and is placed in an area that does not have sensitive material.

The CDC guidelines are going to be based on this risk assessment. As they currently read, the requirement for any device that goes into high-risk tissue is — if it cannot be cleaned, an extended sterilization cycle should be used. It's the cleaning aspect that drives the strategy.

The suggestion I have is that the prion community partner with the sterilization science and infection control communities to develop meaningful protocols and studies so that we can get away from an approach that would necessitate one to literally discard instruments or treat them in a manner that they cannot withstand.

Single user license provided by AAMI. Further copying, networking, and distribution prohibited.

**Comment by Dr. Brown, National Institutes of Health, U.S.A.:** That was a very

common sense exposition of the problems in our field. I attempted to point out yesterday in the discussion of the endoscope that it's absolutely necessary to get away from an all-or-nothing mentality. For example, a developing country that may have two gastroscopes in its entire country can't afford to throw one of them away because it might have been used previously on a patient with CJD. I think there is probably enough science to achieve a consensus with a number of fallback positions where mandated by practical considerations. I am also glad that there is this concern because I would like the WHO to function as a forum to gather available material in one advisory written by the most knowledgeable individuals in the field. These should include people who are users as well as those who are responsible for sterility.

**Comment by Dr. Lederberg, The Rockefeller University, U.S.A.:** I would like to repeat a remark I made earlier. Steam sterilization applied to prions seems to me a certain loser. If it can work at all, it requires doses far beyond those that we are customarily familiar with, and it operates by mechanisms of action that are almost guaranteed to not work well on what we understand today of prion chemistry. What we do understand of that chemistry, however, opens the door to other very simple procedures. I don't know everything that is in a gastroscope but plastic, metal, and glass can certainly withstand conditions that will result in the hydrolysis of peptide linkages to a very, very high order of assurance, assuming these materials can be reasonably well cleaned. Thus, you're not talking about limitations to the penetration of hydroxide ions or hydrogen ions to conduct that hydrolysis. I don't think it should be very difficult to adopt putative standards that would be extremely rigorous in terms of expectant survival; of course, these would have to be corroborated by specific tests. What bedevils everybody is that we don't have easy, convenient, inexpensive, and reliable assays for prion activity. Current assays are laborious and time-consuming but can certainly be done.

**Comment by Dr. Brown:** There was a question yesterday regarding the dose of radioactivity that had been used in earlier experiments. Brain suspensions from animals infected with scrapie, kuru, and with Creutzfeldt-Jakob disease were subjected to cobalt 60 irradiation at a level of 20 megarads. I don't know what that is in terms of kGy, but someone might be able to do a quick conversion. This experiment was performed around 1970.

Someone mentioned to me yesterday that they were surprised that inactivation from incineration was not mentioned. That was a very shrewd observation. The reason it wasn't mentioned is because nobody knows. No experiment, to my knowledge, has been done to determine the amount of inactivation that follows incineration. As most of you probably know, incineration is usually done with a short, several second blast at about 1800°F at which point everything is ashed. I think this is a very timely experiment. At the NIH, for example, we have a smokestack that for 20 years has been, from time to time, releasing material from our own laboratory. Presumably it is sterilized, but nobody knows. The same can be said for all of the carcasses of mad cows that have been incinerated in Great Britain. I am having some difficulty devising an apparatus in my mind that could function as a collector apparatus and I would invite anyone who has any specific detailed ideas on how

such an experiment might be conducted to give us a secure answer.

**Question and Comment from the Floor:** A physicist's answer to Dr. Brown's technical question is that a 20 megarad dose would be equal to a 200 kGy dose. This is quite high, about ten times the typical dose for medical device sterilization. What was the result of that treatment? Did it inactivate the prion?

**Answer by Dr. Brown:** There was no inactivation.

**Final Observations by Dr. Lederberg:** I hope many of you profited as much from this symposium as I did. I'd like to share with you some of my observations.

The first day was devoted to emerging infections and the main burden of my own remarks in this area has been the absolute necessity that we adopt and eternalize a global perspective. Infectious disease knows no national boundaries and we will not be able to protect ourselves at home if we don't pay very careful attention to disease problems around the world. If they don't have a prompt and immediate impact on us in the infectious realm, which many of them will, they certainly do in the globalized economy that we operate in today.

I can also comment that it's a little early to be sounding all the trumpets, but there was a certain triumph of global perspective in the way that Hong Kong dealt with its recent episode of Influenza A (H5N1) and the cooperative efforts, notably involving the CDC, in the monitoring, diagnosis, and strategic planning for dealing with that outbreak. I think Hong Kong has to be congratulated for having looked to the interests of the entire world as well as its own parochial interests in the way that it so aggressively went after that particular outbreak. We've not yet achieved that outlook for some of the great killers in the world, including tuberculosis and malaria.

We touched on antibiotic resistance and the increasing role of nosocomial infection. There was a good deal of emphasis on policies for prudent use of antibiotics as part of our effort to contain what might well be called an epidemic of drug-resistant organisms. We've only begun to think through the system ramifications of: 1) trying to engender a balanced view whereby one offers the utmost in medical technology to any given patient, and 2) the prudence that says 'if you use it, you will more rapidly lose it' with respect to the needs and requirements of future patients.

Personal hygiene practice, especially in hospitals, certainly plays a very important role in this and goes hand-in-hand with meticulous attention to the provision of sterilized surgical supplies. If the hands of the provider are contaminated, there's really no point in having sterile medical devices. Sterilization technology also has a key role. As we have heard, cleaning instruments is probably just as important as the post-cleaning sterilization. It ought to be done in tandem and done every time.

There are other technologies that may come into play during periods of epidemic. For example, face masks may play some role in the droplet transmission on the part of the surgeon. They probably have almost zero benefit in terms of inhalation, certainly the leakage around the mask is 20-30% of total air traffic to begin with, and that's the maximum that can be expected of them. It is conceivable that if there is another great airborne

epidemic, we will again see people wearing face masks for their own self-protection. It would be good to know if there is any scientific foundation for that practice or if the technology underlying it might be improved as well.

Gloves are another example. They are very traditional, yet they are associated with problems such as latex allergy and do not do very well with needle sticks. Gloves sometimes even give a false sense of complacency. If the hand that is in the glove hasn't been washed, there again is a moral hazard with regard to their use. We see individuals in food establishments walking around with gloves on their hands. I'd rather they didn't, because their gloves guarantee that any contamination picked up from one place will go no other place but in my sandwich. Again, there is a certain moral hazard in thinking that the use of gloves has solved a problem when their application has no common sense behind it.

Our session on prions was probably the most startling. We had very elegant presentations by Dr. Prusiner, Dr. Brown, and others which plainly indicated that we are at the advent of a new paradigm and only beginning to understand its implications. Far from the prion being an exogenous biological agent with its own DNA or RNA coding and a life of its own, we start out with the given that these are of endogenous origin and come from within ourselves. Some event has triggered the confirmation of the normal prion protein into the one that gets the label scrapie, CJD, or whatever. The more I thought about that the more I worried that this might have implications for a genesis of communicable disease for which there is nothing in our present paradigm. If the seeds for the development of this agent lies within us we have to ask ourselves what else might trigger it. One presently knows that what triggers it is some of the same that is already present. If, however, it is merely interference with the normal folding pattern of the PrP protein, it really does open the door for any of a wide variety of other agents to interact with a similar process of folding and generate these anew. We do have an incidence of about one in one million sporadic cases of CJD, whether we did have specific extrinsic risk factors or those risk factors were existing cases of CJD or BSE. When we say they were spontaneous, we simply mean we don't know what the incident was. I hope a part of the continuing investigation, particularly in parallel with efforts to interfere with the prion process, is developing a therapeutic interference which will keep open the door to the analogous possibility of even small molecules or infective agents that might trigger the *de novo* formation of prions from existing precursors.

I was also led to contemplate the implications of what was said concerning possible analogies to other neurodegenerative diseases. How far should we carry the analogy? Is it possible, for example, that Alzheimer's disease might have some element of catalysis? Now I'm the first to recognize that there's not a shred of epidemiological or experimental evidence to indicate that this is a communicable disease and I think the odds of that are essentially zero. But, as part of the indigenous pathogenic process, it is not impossible that an existing fibrillary tangle might be autocatalytic and further the precipitation of amyloid. This is something that would, by analogy to the prion story, be subject to experimental investigation. I'm not aware that this experiment has ever been attempted. Now that we have humanized mice that have embodied the genetic risk factors for the human disease, an experiment that could be done to see if the progress of the aging-related tangles might be

accelerated by inoculation of some of the same. I do not foresee that this will enter the realm of communicable disease but once the remark has been made, obviously one would have to keep one's eyes open for some ultimate emergent possibility.

As we entered our discussions on sterilization, I found myself in a little bit of a dilemma. I saw the enormous success of sterilization technology from the days of Lister and Pasteur on. I've used the steam autoclave as much as anybody in my own experimental work. I depend on its successful application for the preparation of my own culture media and I rarely stop to think about the mechanistic basis of its operation. I didn't have to ask myself what were the molecular targets on a variety of viral and/or bacterial organisms. It's really only when we face new paradigms, either new kinds of materials that need to be protected or new contagious agents as in the prion story, that I think it behooves us to ask, "Should we not be giving some thought about returning to the fundamentals?" If we really want to have very high predictive value about the utility of either existing or novel sterilization technologies, we should pay some attention to the question of how they work.

With the nearly adequate exception of radiation sterilization, I think we have a pretty good idea what the targets are. Exactly what is the vulnerable target when you're using chlorine dioxide or hydrogen peroxide or steam sterilization? I predict that this will only become important when we face new challenges similar to those that we are in the middle of at the present time. I've done a little work myself on trying to figure out how chlorine works as a disinfectant and it becomes conceptually, as well as operationally, a rather difficult question to answer because there are so many targets. There are so many substances within the cell that chlorine can react with. We did find that the pyrimidine bases of DNA of *B. subtilis* are chlorinated; these can be mutagenic at a very low level. That might be one but it's by no means clear that this is the primary disinfection mechanism in that particular instance. I just want to stress that I couldn't find very much else so others will have to contribute to give us clear answers to that kind of question. It doesn't matter as long as it works but there are so many difficulties in trying to both foresee and validate what is going to work with respect to prions that we do have to go back to these basic issues. Sterilization is, like antibiotics and other chemotherapeutic agents, a differential biocide. But, in the case of antibiotics, we want to preserve the human host as we destroy the bacterium. In the case of a biocide or sterilization procedure, generally speaking, it is materials we're trying to preserve and protect as we destroy the target bacterium. The procedures we are talking about here must be cheap and simple. I don't see anyone investing two to three hundred million dollars for the development of a new sterilizing procedure, which is the general cost for developing a new antibiotic.

Can we sterilize surgical instruments? I've already made a remark on that but I realized I'd already published a very extensive paper on a related topic and I'd like to present it to you. It's from a collection published by the Royal Society and my remark is about cooking eggs. The chemistry of boiling an egg is reasonably well understood. The fried egg is beyond us. The pyrolytic products of eggs are probably innumerable. This led to further substantial investigation on the part of other contributors to the volume which actually went into the engineering technology of cooking eggs. The second edition will have another chapter specifically directed at how to achieve appropriate sterilization in light of the

prospect of *Salmonella enteritidis* infection which is quite a problem in the United Kingdom and so you will get very elaborate procedural protocols for how to accomplish that result. It reminded me a little bit of the autoclave technology that was mentioned earlier. But, I have a little footnote. I've little doubt of the chemistry of an acid or alkaline hydrolysis of egg protein and that's what I come back to again of what I'm sure is an easy refuge for dealing with matters like the disinfection of surgical instruments.

I had a note of nostalgia when Dr. Brown remarked that, in the face of the discovery of the catastrophe of the numerous dozens of cases of CJD from the use of human growth hormone derived from human pituitaries, what had come to the rescue was the available alternative of recombinant DNA. I recalled the hysteria in 1975 surrounding recombinant DNA. There was an enormous outcry about how dangerous this was and how it would do us all in. I think we came to realize we can end up with a much greater hazard than that which arises from the Frankenstein-like machinations of the laboratory, and in this particular case, the laboratory machinations were the source of our rescue.



# Comments from Prof. Alan Tallentire

## *Recipient of the 1998 Kilmer Memorial Award*

Thank you Dr. Gussin for the very generous and complimentary remarks that you have made about me — thank you too for presenting me with the Kilmer Award. The last occasion I found myself in this position, I was 11 years old and was awarded my Boy Scout's Semaphore Signalling Proficiency Badge. So naturally, its a role to which I am not accustomed.

It gives me enormous pleasure and pride to have my name connected with that of Fred Kilmer, to whom we properly pay tribute when we meet on these occasions. As we learned on the first day of the Conference and throughout its progress, Kilmer was a remarkable man; his output, contribution, and vision were staggering and I am delighted to note that he started his professional life as a pharmacist. It is in this one regard only that I can claim to be his equal. I started my working life as an apprentice pharmacist in a chemist shop (drugstore) but I soon learned the hard facts of life associated with the commercial world. So, on qualifying as a pharmacist, I chose to take the 'soft option' of academia. No 'publish or perish' in those days.

Having chosen this option, I have always regarded myself in my working life as being one of society's favored few. 'Favored', because as an academic researcher I have had to answer to no one, other than journal reviewers. The whole of my professional life I was reasonably well-paid to allow me to pursue my hobby. Following that hobby, of course, was challenging, exciting, but most of all, enjoyable. Work for me, like many others in this room, has been 'fun'.

'Favored' also because I had the good fortune to be drawn into the research field of radiation science at just the right time. A good number of you may not realize that in the immediate post-war years, nuclear and radiation science were essentially the province of government laboratories. High wire fences, security guards and passes, nuclear secrets and spies were *modus operandi*; nuclear science and radiation technology were not in the public domain. In the early 1950s, by a stroke of good fortune, we at Manchester University gained access to the radiation research field.

The good fortune was a chance meeting on the train between my research supervisor and the technical director at Metropolitan Vickers (MV). The firm of MV was Britain's largest electrical engineering company and was located in Manchester. MV had developed a new type of commercial electron beam radiotherapy machine and the prototype was made available to 'outside bodies' to allow the study of radiation effects on materials. The technical director reckoned that if his machine could kill cancer cells in humans, it might equally 'zap' microorganisms and so be of value to the pharmaceutical industry as a new way of manufacturing sterile products.

Were we interested? We certainly were. We had an appropriate microbiological test



system and were ready to experiment. I well remember our first visit to the electron beam machine. My research supervisor and I traveled from the University to MV in his car — this in itself was an experience to savor. At this time, virtually no new cars were being manufactured and car ownership in the United Kingdom was limited to the rich by inheritance, of whom my research supervisor was one. His car was a pre-war Standard 8. It was a left-hand drive destined for the continental market just as the war broke out, but never exported; he was terrified of driving it and for good reason. He was not a practical man — he specialized in metaphysics. Sadly, he also suffered from poor sight. The 5-mile journey was undertaken at Grand Prix speed, theoretically within inches of the left-hand pavement of the road, but, in practice, regularly hitting the curb and on two occasions, actually mounting it.

On arrival at the Research and Development Laboratories of MV with me clutching the test samples, we were directed to a large experimental hall. There, in the center, stood a gleaming assembly of electrical and high vacuum equipment (wave guide, drift tube, radio frequency generator, focusing magnets, throbbing vacuum pumps, wires, dials, valves, etc.) — an electron linear accelerator. For an impressionable embryonic researcher like myself who had been brought up on pharmaceutical ‘pink string and sealing wax’, it was heaven. This was where I wished to be, or so I thought.

We put the test samples in place at the end of the drift tube ready for ‘zapping’ with the shower of electrons. We then stood around in the control room for about 3 to 4 hours while the engineer operators tuned the machine and searched for the beam. Unfortunately, there wasn’t to be a beam that day. My supervisor, not being a practical man, dismissed the technology as being too unreliable for the pharmaceutical industry — radiation sterilization using electrons from a linear accelerator was written off by him as a commercially feasible process. For some considerable time after our unfortunate experience, he was right.

Despite this early operational setback, radiation research and technology at Metropolitan Vickers had completely captivated me. I returned with my samples weekly for several years in the ‘50s, but always alone via a number 49 bus. These visits to MV gathered me into the fields of radiation biology and sterilization science — a fate from which I have never recovered in the 45 or so subsequent years.

In my professional life, I have been favored too in the people with whom I have had the good fortune to work and collaborate. Foremost amongst these are the students who studied with me for Ph.D. degrees. Many were from overseas and almost all have returned to their native lands to enter academia or commerce. As students, they were a tremendous group of individuals, wholly committed, wonderful people who taught me a great deal. My debt to them is enormous. There was no greater reward and stimulation for me than to work with these young people — I just hope that they had fun too.

In addition to the graduate students, I have had much pleasure and benefit from working with postdoctoral colleagues and collaborators from industry, many of whom are amongst us here. Work with them also was invariably fun because it was applied and involved putting into practice many of the notions that had been developed with my students. These activities provided a balance between academic research and commercial development. I owe a great deal to these colleagues too.

Radiation biology and sterilization science are international subjects requiring debate and discussion at international venues. We have all benefited from this need but none more so than those of us who were in at the beginning. Long before intercontinental travel became popular, we, the scientists, traveled the globe to debate our common love. We referred to it as 'better living by science' or 'around the world on a survival curve'.

Dr. Gussin, it was very good of you to speak so well of me. I thank you all for the compliment you have paid me, and through me, to all the people who have joined me in having fun over the past 45 years or so. My thanks to you all.