

# STERILIZATION OF MEDICAL PRODUCTS

# STERILIZATION OF MEDICAL PRODUCTS

## Volume VI

**Editor:**

Robert F. Morrissey, Ph.D.

Johnson & Johnson  
Sterilization Sciences Group  
U.S.A.

Johnson & Johnson

**Proceedings of the International Kilmer Memorial Conference on the Sterilization of Medical  
Products**

Brussels, Belgium  
June 13-15, 1993

® Johnson & Johnson 1993

ISBN 0-9221317-46-8

**Polyscience Publications Inc.  
Morin Heights, Canada**

Printed in Canada



# GENERAL CHAIRMAN

P.W. Thompson  
University Hospital of Wales

## ORGANIZING COMMITTEE

J. Brugmans	Belgium
M. Favero	U.S.A.
C. Grenshaw	U.K.
M. Korczynski	U.S.A.
P. Lavrysen	Belgium
P. Leglise	France
J. Masefield	U.S.A.
R. Morrissey	U.S.A.
A. Parisi	U.S.A.
A. Tallentire	U.K.

*Held under the patronage of Antonio Ruberti European Commissioner for Science and Research*

## Copyright

## Preface

## Opening Ceremony

### Opening Remarks

Dr. Peter W. Thompson

Mrs. Wivina Demeester

Philip E. Carne

### Keynote Address

Mr. Bruno Hansen

## Session I – Infection Control

### Public Health Implications of Medical Waste

William A. Rutala and David J. Weber

### Fungal Infections in Immunocompromised Hosts, Particularly Among Cancer Patients

Françoise Meunier

### Nosocomial Infection Trends in Europe

Donato Greco and M.L. Moro

### Nosocomial Outbreaks of International Significance

William R. Jarvis

### Risk Factors for Surgical Wound Infections

Hervé Richet

### Hospital-Acquired Infections in Japan

Hiroyoshi Kobayashi

### Discussion – Infection Control

## Session II – Pharmaceutical Emerging Issues

### Opening Remarks

Bryan H. Hartley

### Aseptic Processing and Terminal Sterilization: European Pharmacopoeia View

Henning G. Kristensen

Single user license provided by AAMI. Further copying, networking, and distribution prohibited.

### An Overview of Aseptic Processing Versus Terminal Sterilization

R. Michael Enzinger and William R. Frieben

Predictive Sterility Assurance For Aseptic Processing

Colin S. Sinclair and Alan Tallentire

Rigid Isolation Barriers: Decontamination with Steam and Steam Hydrogen Peroxide

Irving J. Pflug, Hans L. Melgaard, Craig A. Meadows, Jack P. Lysfjord, and Paul Haas

Discussion – Pharmaceutical Emerging Issues

### **Session III – Risks, Standards, and Methods**

Opening Remarks

Marilyn N. Duncan

Risk Assessment: The Inexact Art of Hazard Evaluation

Daniel Wartenberg

Patient Infections: The Relevance of Sterility Assurance Levels

Martin S. Favero

ISO Standards Activities – The Challenges Ahead

William E. Young and Virginia C. Chamberlain

Validation of Methods for Bioburden Estimation

Eamonn V. Hoxey

Establishing EO-Sterilization Residue Limits Using Health-Based Risk Assessment

Barry F.J. Page

Discussion – Risks, Standards, and Methods

### **Session IV – Radiation Sterilization**

Opening Remarks

Kenneth H. Chadwick

Design and Development of a Unique Electron Accelerator Facility

Thierry Descamps

ESR-Based Analysis in Radiation Processing

William L. McLaughlin, Marc F. Desrosiers, and Michael C. Saylor

Radiation Process Data Collection, Analysis, and Interpretation

Michael C. Saylor, Steven W. Baryschpolec, Lisa M. Hurwitz, and William L. McLaughlin

Diversity of Accelerator Technologies for Medical Product Processing

Theo Sadat and Allison Ross

AAMI Dose Setting: Ten Years Experience

Joyce M. Hansen

Discussion – Radiation Sterilization

### **General Discussion**

Single user license provided by AAMI. Further copying, networking, and distribution prohibited.

Robert F. Morrissey





The 1993 International Kilmer Memorial Conference was held in Brussels, Belgium, from 13 June to 15 June 1993 and was attended by delegates from 23 countries. This publication of *Sterilization of Medical Products, Vol. VI* comprises the proceedings of the 1993 Conference which was dedicated to the memory of Dr. Fred B. Kilmer, the first Director of Research at Johnson & Johnson and a pioneer in medical product sterilization and infection control.

The Conference was made up of four sessions devoted to Infection Control; Pharmaceutical Emerging Issues; Risks, Standards and Methods; and Radiation Sterilization. We were very fortunate in having Dr. Peter W. Thompson as Conference General Chairman. He expertly guided the program from session to session and provided a link between the infection control practitioners and the sterilization scientists.

At the Conference Banquet, the Kilmer Award was presented to Dr. Carl W. Bruch of the U.S. for “leadership in advancing sterilization science and promoting process validation standards”. Dr. Bruch has had a distinguished career in the field and has influenced the development of all aspects of sterilization validation methodology as well as the development of national standards associated with the technology.

New Brunswick, NJ

R.F. Morrissey

**Opening Ceremony**

**General Chairman: Dr. Peter W. Thompson**

*U.K.*

**Keynote Address**

**Mr. Bruno Hansen**

*European Commission, Belgium*



# Opening Remarks

Dr. Peter W. Thompson

*University Hospital of Wales, U.K.*

Welcome to the Sixth International Kilmer Memorial Conference so named after Dr. Fred B. Kilmer, a pioneer in infection control and sterilization. The fact that this is the Sixth Kilmer Conference, and like the previous ones, is attended by so many prominent delegates testifies not only to the importance of controlling infection but the value of conferences such as this which provide a forum for the exchange of information in a particularly friendly atmosphere.

The headline in Friday's edition of *Le Soir* in Brussels read "AIDS — No Remedy But Some Encouraging Progress." We are making progress but we cannot slack off. Even now new infections keep popping up and I have recently heard about a peculiar viral outbreak in the United States. You may be surprised that an anaesthetist finds himself here. Like others, anaesthetists depend on sterilization. We depend on single use equipment and I would remind you that Joseph Lister was personally present on December 21, 1846 at the first public demonstration of general anaesthesia in Britain. He went on, as everyone knows, along with the German Pettenkofer to be the co-father of antiseptic surgery.

In this conference, there are four main sessions covering Infection Control, Pharmaceutical Emerging Issues, Radiation Sterilization, and Risks, Standards and Methods. Standards are of fundamental importance. Standards of practice and standards for equipment are assuming a new prominence in Europe because they will be used to a large extent for supporting the medical device directives. We hope today (June 14th) will be notable in the history of medical devices in Europe because it is expected that the Council of Ministers will actually sign the Medical Device Directive, thus making it European law. Among the many areas of discussion is the one surrounding the definition of a medical device. This is of particular interest for many of the delegates because there is still considerable debate as to whether a sterilizer is a medical device. What I wish to draw your attention to is the fact that, among other things, modification of the anatomy or of a physiological process is part of the current definition. According to this definition, the guillotine would be a medical device!

This conference is essentially an educational forum. I only hope that the deliberations and information provided here will enable our patients to view the devices applied to them with a little less doubt and anxiety.



# Opening Remarks

Mrs. Wivina Demeester

*Government of Flanders, Belgium*

It is my pleasure to address such an eminent international meeting of scientists. I am very pleased that this conference is held in our country this year and more precisely in our three-times capital, Brussels. You are all familiar with the fact that Brussels is the capital of both Europe and Belgium, but I also take pride in stressing that Brussels is the capital of Flanders. I would like to thank the General Chairman, Dr. Thompson, and the Organizing Committee for choosing this location, thereby allowing me, as the Flemish Minister of Health Institutions and Social Welfare, to speak. One merit of the Kilmer Conference is that it offers a wonderful opportunity for scientists from around the world to reflect on a varied range of medical and public health issues. I also value the efforts of Johnson & Johnson. This Conference is a rare example of a large multinational company engaging in an entirely non-commercial mission by spreading scientific information and helping to improve medical care all over the world.

Health care is a question of combining technology and science with human resources and human efforts, the latter of which are important for quality. This also defines my approach to the policy for the Flemish Health Institutions and Social Welfare. To better understand this approach, let me first describe the Flemish policy within the context of the Belgian political structures. Belgium has no less than three language communities and three regions, each with their own political powers. The powers of these communities include cultural and personal matters, such as social welfare with programs for the general public, families, youth, disabled people, and the elderly. The health institutions' policy — both financing and recognizing our health institutions' prevention policy — is a community matter, whereas public health and the financing of medical care belong to the authority of the federal government.

I am proud to say that Flanders, although a small region, is big in care. Our social system is well-developed and universal, allowing access to all people equally, not only the socially deprived. We have very little in the way of class medicine or class care and I believe this to be one of the greatest achievements of our social democracy. The welfare provisions organized by the Flemish Community offer a wide range of help or assistance facilities which are open and accessible to anyone. In 1993 alone, a budget of approximately 56 billion Belgian francs — or roughly 1.8 billion US dollars — is available for a population of some 5.5 million people.

We organize a wide range of counselling and care facilities for the general public ranging from family and youth counselling, judicial welfare including counselling of convicts and victims, psycho-medical and social assistance, and help lines. There are various assistance programs aimed at better emancipation and integration of the socially least privileged groups, including specific aid to foreign workers. In addition, living facilities for the homeless, battered women, and young mothers are offered.

The Flanders policy aims at co-responsibility of the care receiver, and of society in general.

Care encompasses prevention, by structural measures, in all fields such as education, housing, employment, etc. as well as by educating and informing people about the social abilities. Prevention is also enhanced by a better cooperation between the various institutions in our wide range of assistance facilities. We wish to develop and enhance multiple-assistance centers that can cope with a wide range of demands and can offer integrated help to all aspects of complex problems. In all cases, care should eventually make itself unnecessary — it should remediate or teach the care-seeker to cope by himself.

The Flemish community organizes and subsidizes day care for children — either in special centers or by daytime mothers — enabling both parents to have both a full-time job without spending a lot of money on nannies and babysitters. Child care organized by the Flemish community also includes preventive medical and hygienic care. For the specific target groups there is also a wide variety of custom-made help. There is an ever increasing number of senior citizens, now constituting about one-fifth of the Flemish population and likely to rise to one-third of that population within the next 30 years. Our policy for the elderly does not include care facilities only for those who need assistance. It also appeals to the many healthy senior citizens who wish to participate fully in all social fields. Care is organized in an elaborate network of diversified facilities. Our aim is to offer custom-made help. It is the wish of most elderly and disabled persons to live as long as possible in their own environment among their families. Flanders has an elaborate network of home nursing and family care, assisting seniors, disabled, and sick people in their daily chores of cooking, laundry, cleaning, and shopping. Approximately 28,000 people are helped by these services. There are service centers where senior citizens can enjoy social and cultural events and at the same time are offered services with all required health and social information. There are also day care centers for older people who live at home or with their families but who require additional care. The care approximates that of a live-in nursing home, and the people are trained to improve or maintain their independence.

The next step on the scale are service flats. These consist of small, well-accommodated apartments or houses where the dweller can enjoy services such as meals, laundry, cleaning, and maintenance. This type of housing is in high demand and therefore we have financed an incentive program allowing for 5,000 new flats.

Nursing homes are specifically meant for those who need the most care. They offer professional nursing around the clock to the most dependent people. Since there are many alternatives, admission is often delayed to an older age. Even if nursing homes should be reserved to the most dependent people, everything is done to make these individuals help themselves whenever they can. Apart from these more traditional care provisions, we also provide residential care for shorter periods, for holidays, or just overnight. We are also experimenting with foster parenting for the elderly for shorter or longer periods of time.

There are approximately 60,000 disabled persons in Flanders. They are encouraged to participate in all aspects of social life and to live as independently as their mental or physical disability or social handicap allows them. There are several types of residential and semi-residential facilities, as well as various home services which enable disabled people to live among their families, lightening the burden of their caregivers. Day or night care institutions are available, as are facilities for short periods of time. Some people may live quite

independently in assisted living facilities where they can enjoy a great deal of privacy. The Flemish Community also encourages employment of disabled people in sheltered workshops and in the corporate world by giving special incentives to employers willing to engage a disabled person.

Within the medical care administered in hospitals and medical centers the communities, among others, are responsible for the planning and acknowledgement of institutions, for quality control for regulations and subsidies, for investments, and for prevention. Basic regulation and financing of the medical care administered to patients, however, remains a federal responsibility, although they have a great impact on the possibilities of the community's policy.

Within my competence, I wish to extend the basic principles of my policy for welfare institutions to the health institutions. I wish to develop home care and therefore I will give incentives to enable families to care for their siblings or relatives without suffering negative consequences in their careers. In addition, I shall examine the possibility of giving non-professional home care givers proper statute.

Another point I want to stress is quality care. The quality of the cure as well as that of the care matters to patients. In terms of hospital care I do not only mean a nice environment, good food, and friendly staff — though these certainly should not be forgotten. Quality care also implies information to patients; they should be involved in all aspects of management that concerns them and it means that their families and relatives should also be welcome. It also means, of course, that all care administered should be in the best interests of the patient and should be administered in a humanitarian manner.

In that respect, I wish to encourage palliative care for terminally ill people. The aim is to provide quality time rather than quantity — the latter being achieved by overzealous therapy and allowing the most comfortable circumstances to live the last phase of one's life. Palliative care can be administered at home or in hospital units. There are currently 66 initiatives involved with home care which have been acknowledged by the Flemish Community. I am willing to give them an additional project subsidy if they can extend their work to palliative care and inform the public about this type of care. Palliative care should also be encouraged in health institutions and in my opinion belongs to overall quality care. The current experiments should teach us whether palliative care is best organized in special units or on the different wards. I believe it is our humanitarian and moral duty to make this care available to all patients who are in need of it and it should become a basic right for anyone who is entitled to it.

As I am not only the Minister of Welfare but also of Finance and Budget, allow me to conclude with a few words on financial implication. It is clear that such a universal health and care system is very expensive and demands high budgetary sacrifices. It is only the solidarity of the entire society — the imposed solidarity of the tax payer as well as the free solidarity of volunteers — that enables us to maintain it. However, one of the weak points of this system is that it might encourage social shopping as well as other abuses. If we wish to maintain our system in the future I believe we all must do what we can to make it more efficient — perhaps even building in a certain degree of sensitivity. We shall therefore have to make political choices on financing and budgeting so as to develop our care system in the future.





# Opening Remarks

Philip E. Carne

*European Chairman, Professional Sector, Johnson & Johnson*

It is a privilege for me to welcome such a distinguished group of speakers, delegates, special guests, and former Kilmer Award recipients to the Sixth International Kilmer Memorial Conference on the Sterilization of Medical Products. In the audience are many of the world's leading scientific investigators in infection control and sterilization process technology, as well as experts in medicine, pharmaceutical sciences, regulatory affairs, and international standards. In all, you are about 225 strong, representing 23 different nations.

Speaking on behalf of Johnson & Johnson, we are deeply honored to be able to sponsor this conference along with the European Commissioner for Science and Research, Antonio Ruberti. We thank Dr. Peter Thompson for agreeing to serve as Conference General Chairman and for the participation and support of the Flemish Government, represented by Minister Wivina Demeester.

The objective during our 2 days of deliberations here in Brussels is consistent with the five prior Kilmer Conferences, namely, to provide a forum for the sharing of technical information related to the health and well-being of people around the world with special emphasis on the prevention of infection through microbial control practices.

This is a non-commercial conference and many of you may be wondering why Johnson & Johnson would sponsor such an event. Since its founding more than 100 years ago, Johnson & Johnson has pioneered advances in infection control and sterilization. The development of the first ready-made, ready-to-use surgical dressings by our company in the mid-1880s marked the first practical application of the theory of antiseptic wound treatment. The new concept was based on the discoveries of Sir Joseph Lister, the noted English surgeon.

One of the most significant accomplishments of this century took place in the mid-1950s when our Ethicon Division pioneered the application of electron accelerators for medical product sterilization using surgical sutures.

Today, ours is the world's leading health care corporation, with 166 operating companies and over 82,000 employees in 52 countries. We produce and market a broad range of consumer health care products, prescription pharmaceuticals, and products used by medical professionals in more than 150 countries.

At Johnson & Johnson we have a long-term outlook in managing the business and are guided in our everyday conduct and social responsibility decisions by a Corporate Credo. The Credo, originally written by General Robert Wood Johnson in the 1940s, is a reminder of our responsibilities to four constituencies: our customers, our employees, the communities in which we live and work, and our stockholders.

Against that backdrop you can better understand why we are pleased to be able to help provide this forum for the transfer of knowledge about improved health care through infection

control technologies.

In addition, this conference and its stated objective are part of the legacy left to us by Fred B. Kilmer, Johnson & Johnson's First Scientific Director, a man who served the company for 45 years. Dr. Kilmer's early goal was to awaken medical interest in Lister's findings, and he accomplished this by disseminating a compilation of reports by eminent surgeons of the time. The monograph, "Modern Methods of Antiseptic Wound Treatment", went through five editions by 1893.

Part of Kilmer's other work in the 19th century included the classic article, "Modern Surgical Dressings", published in the *American Journal of Pharmacy* in 1897. Much of that article, dealing with microbiological control of the environment, validation of the effectiveness of sterilization processes using resistant bacterial spores, and the concept of bioburden is incredibly similar to today's GMP requirements.

In foreseeing the trend to asepsis, later called sterility, Kilmer wrote: "All antiseptic agents do not possess the power to destroy or kill organisms. The aim sought is a condition of freedom of septic material or microorganisms. In this transition, antiseptics has not been abandoned, but has developed into its higher form — **asepsis**. The antiseptic dressing has not been discarded, but has become aseptic".

This was written at a time when many surgeons were still operating ungloved and in street clothes, in blood-spattered frock coats, and with non-sterile instruments. The postoperative mortality rate was as high as 90% in some hospitals.

As a prolific and highly respected writer on scientific and medical subjects, Kilmer influenced the profession's attitude over the years through educational publications such as "Red Cross Notes", begun in 1897; "Red Cross Messenger", launched in 1908; and through "Notes and Abstracts", which he started in 1921. He was a talented writer as well as a distinguished scientist, and produced numerous papers for professional publications and trade journals throughout his long career.

In memory of Fred Kilmer, this conference series was initiated in 1976 in the United States. Subsequent Kilmer Conferences were held in 1980 in Washington; in 1982 in Sydney; in 1985 in Beijing; and in Moscow in 1989.

One of Dr. Kilmer's characteristics was his tireless search for new and improved asepsis products and procedures to provide the best possible medical care for all people. Contemporary challenges include the sterilization of increasingly complex surgical devices, nosocomial infection control, the management of AIDS and tuberculosis, and the harmonization of international standards and practices concerned with sterility. We continue to see exciting advances with new sterilization technologies, developments in machine-generated radiation sources, and ways to measure sterility assurance. All of these, and a host of other related topics such as risk assessment and aseptic processing, will be discussed during what promises to be an outstanding conference.

Around the world, people have come to expect to live longer and healthier lives. Few scientific meetings are capable of having a direct effect on these expectations. This conference, however, is an exception. You have great potential to positively impact human health and well-being.



# KEYNOTE ADDRESS

## Biomedical and Health Research in Europe: 1993 and Beyond

### Bruno Hansen

*Life Sciences and Technology Directorate,  
European Commission, Belgium*

Minister, Mr. Chairman, Ladies and Gentlemen, I would like to thank the organizers for inviting me to give the Keynote Address at this important and prestigious conference. From someone who has spent more than 28 years in research in the private sector, I am very pleased to have the opportunity to express my views on the future of biomedical and health research in Europe and at the same time convey to you how the European Commission operates in this very important field.

Let me start by saying that the need for further biomedical research remains enormous. Major challenges still facing us today concern the courses and treatment of life-threatening diseases and the many diseases which result in disability and suffering. Cardiovascular diseases and cancer are the major causes of death in industrial countries, psychiatric diseases show an increasing prevalence. There is a high interest in AIDS because of its devastating effects on young people and the lack of any known cure. Attention must also be given, however, to other diseases such as allergies and musculoskeletal disorders which result in significant disability and suffering.

Why is it important to have a strong focus on biomedical and health research in the future? I dare say that health has a very high value for every European citizen. Health costs absorb 6-8% of the GNP, and rising health care costs have become a concern for the EC countries. At the same time European citizens are demanding more high quality care. New health-related technologies and health care systems are expected to face these problems. The escalating public health expenditures require innovative research and development into the treatment of very costly chronic diseases, yet the development of new products has become progressively more expensive, both in terms of time and money. According to recent studies in the U.S., the current cost of developing a new therapeutic drug is around \$250 million. The same cost was close to \$50 million in the 1970s. Further, development time has been prolonged from close to 4 years in the 1960s to up to 12-14 years in recent years due to the every increasing requirements for establishing efficacy and safety and the lengthy approval procedures.

What are the objectives of the European community? I would like to state some of the issues that I feel are very important. One is to increase the scientific efficiency of relevant R&D efforts in the Member States through their gradual coordination at the Community level. A related goal is to increase the economic efficiency through sharing of tasks and strengthening joint use of available health research resources.

A second important objective is to improve scientific and technical knowledge in the R&D areas selected for the importance of the Member States and to promote its efficient transfer

into practical applications, taking particular account of potential industrial and economic developments in the selected areas. I also believe that we should optimize the capacity and economic efficiency of health care efforts throughout the countries and regions of the Community.

Another objective is to obtain, through coordination of similar projects in Member States, results from a larger sample size more quickly and with a higher degree of confidence. Last but not least, I think we should harmonize the methodologies of different national projects through coordination so that results from different countries may be compared directly. How do we deal with these objectives and how do we communicate and put forward our proposals?

In formulating future programs in biomedical research, the Commission will have to take note not only of the views and opinions of national experts who are represented in the program committee for Biomedical and Health Research, but also those from other advisory committees, such as the Industrial Research and Development Advisory Committee (IRDAC). This committee is very important because the views of industry are represented. These advisors and many others are emphasizing the need for stronger focus on future research. For instance, national experts have recommended that the overall objective of the program be the improvement of human health through advances in prevention, diagnosis, and treatment of diseases through health care delivery systems and public health policy. This group also emphasizes that the program should contribute to strengthening the scientific and technological basis of industry in the Community. They further stress that the program should be developed in accordance with the principles of subsidiarity which means that the Commission should not do anything which can be done better at a national level and that primary attention should be paid to the ethical, social, and legal aspects of the program. This is the advice the Commission has received from national experts.

I would like to concentrate today on the recommendations we have received from industry. I have been a member of IRDAC for 3 years and I happen to chair a working party on biomedical research that has representation of the top research level from 28 companies from Europe. It was an interesting experience to listen to these individuals discuss what we at the Community level could do for the future. You have to remember, Commission funding is minute compared to industry expenditures in this area, less than 3 percent. So we have to be very careful to be functional and focused in what we are spending our money for. IRDAC stated that the challenge for biomedical research is not only adding years to life, but also life to years. Their recommendation stated that, in spite of dramatic progress during the latter half of the 20th century, numerous medical needs remain to be satisfied. Recent impressive discoveries in the life sciences should provide tremendous opportunities for significant advances against life-threatening diseases as well as diseases associated with aging and those that result in significant disability and suffering.

The IRDAC recommendation also indicated that the steady growth in the elderly population in Europe will result in increasing therapeutic and economic demands and that active promotion of biomedical research is needed to help keep the social burden tolerable. IRDAC advises a longer term approach to EC biomedical research and the creation of a more positive overall environment for this research in Europe. This, I believe, is a very important issue. We need, in the future, to be much better at informing the general population and give them

proper perspective regarding advances in science and technology so that they can take part in the dialogue. I would like to highlight a few other recommendations from IRDAC to the EC Commission. The advice from IRDAC also emphasized that any effort should ultimately be directed toward making valuable drugs and devices available to the patient as soon as possible. They also stated that the EC should provide more active support to clinical research and clinical trials in high risk research areas. Centers of excellence should be established. Furthermore, it is recommended that the EC should contribute to setting up the appropriate framework for clinical trials in Europe. This would mean aiming at the harmonization of clinical protocols on the basis of the European code of Good Clinical Practice and establishing standard ethical requirements for patient participation throughout Europe. Such harmonization of medical practice throughout Europe should be encouraged. It would contribute, in particular, to the collection of more reliable information concerning health status of the European population and to a more unified market. Harmonization of the legislation at European level should be actively pursued. The main concern should be clarity, as well as compatibility, with legislation in all parts of the world. Particularly, the efforts that have been launched within the international Conference on Harmonization should continue and the scientific basis for toxicity and carcinogenicity tests and standards should be reviewed. The development of *in vitro* alternative testing methods should be more actively encouraged recognizing that animal experimentation will remain necessary at certain stages of drug development.

I would like to now focus on what the European Commission has done to date. With the launching of the first biomedical and health program, the so-called Biomed I, a European research community has been born. More than 3,500 teams are collaborating within 117 concertation networks. Two hundred additional networks are to be created to encourage cooperation between teams of all EC and EEA countries and between complimentary disciplines, with a view to tackling health-related problems not readily resolved. Funds allocated so far are not for research itself (except for the human genome analysis) but for building and coordinating networks. The next extension of this program is intended to go beyond networking and to engage in cost sharing research.

In conclusion, I strongly believe that the global, long-term perspective on basic biomedical research in Europe will need to be strengthened, with an emphasis on the importance of multidisciplinary and interdisciplinary research. As an example, basic research in the diseases involving the central nervous system necessitates the cooperation of pharmacologists, cell biologists, molecular biologists, and medicinal chemists. With regard to the latter statement, 20% of health care costs today are related to brain-based problems. I strongly believe that there is a need to develop the scientific and technical basis necessary for the evaluation of new drugs and devices not only in this area but in others as well. This includes development of *in vitro* tests and animal models as well as reliable, valid therapeutic end points for clinical testing. I also feel that it is important that the research is carried out with a collaboration between industry, research centers, universities, and the authorities responsible for the verification of the quality of drugs. Lastly, performing epidemiological studies on a common European basis is essential for identification and characterization of causes of the major basic diseases and for better planning of the resources in the health care sector and as a basis for increased harmonization of regulations and standards. I would like to wish you the best for this

conference.



**Session I**

**Infection Control**

**Chairman: Giuseppe Ippolito, M.D.**

*Italy*



# Public Health Implications of Medical Waste<sup>1</sup>

William A. Rutala, Ph.D., M.P.H. and David J. Weber, M.D., M.P.H.

*University of North Carolina School of Medicine, U.S.A.*

Disposal of medical waste has emerged as a major problem. This problem has developed as a result of isolated instances of public exposure (e.g., medical wastes washing ashore in some coastal areas) and the perceived threat of acquiring AIDS via this waste. This has led to restrictive rules governing the disposal of medical waste in many countries and an increase in the volume of waste defined as infectious. Coincident with an increase in volume of infectious waste, the options for medical waste treatment and disposal are diminishing because of space and environmental concerns. The purpose of this article is to critically review the medical waste problem by: defining and characterizing medical waste, evaluating current medical waste management practices, assessing the public health implications of medical waste management through an analysis of the scientific data, and examining the impact of stringent medical waste regulations.

# Characterization of Medical Waste

Despite the attention given to medical waste by the public, the media, and all levels of government, the terms “hospital waste”, “medical waste”, “regulated medical waste”, and “infectious waste” are often misused as synonymous. Hospital waste refers to all waste, biological or nonbiological, which is discarded and not intended for further use. Medical waste refers to materials generated as a result of patient diagnosis or treatment such as soiled dressings or intravenous tubing. Infectious waste refers to that portion of medical waste which could potentially transmit an infectious disease (39,54). The Congress and the U.S. Environmental Protection Agency (EPA) used the term “regulated medical waste” rather than “infectious waste” in the Medical Waste Tracking Act (Mwta) of 1988 in deference to the remote possibility of disease transmission associated with this waste (54). Thus, “medical waste” is a subset of “hospital waste” and “infectious waste”, which is synonymous with “regulated medical waste” from a regulatory perspective, is a subset of “medical waste”.

Guidelines produced by the Centers for Disease Control (CDC) have designated five types of hospital waste as infectious (12,22). The EPA guidelines consider the same five types of waste as infectious but also designate communicable disease isolation waste (Table I) (53). In a systematic random survey of all U.S. hospitals conducted in July 1987 and January 1988, the overall compliance rates with the CDC and EPA recommendations were 82% and 75%, respectively. Not only were the majority of hospitals in compliance, but the hospitals frequently designated other hospital waste as infectious, including contaminated laboratory waste (89%), surgery waste (83%), dialysis waste (83%), items contacting secretions (63%), waste from intensive care units (37%), and emergency room waste (41%)(39).

A key component in evaluating the impact of a medical waste management program is the quantity of waste produced per patient. Hospitalized patients in the U.S. generate about 15 pounds of hospital waste per day. The amount of hospital waste generated by U.S. hospitals is approximately 6,700 tons per day; this is equivalent to about 1% of the 158 million tons of municipal solid waste produced annually. U.S. hospitals designate at least 1,000 tons of waste per day as infectious (approximately 15% of total hospital waste by weight) (39). Not surprisingly, the percent of medical waste treated as infectious increases with the number and types of medical waste classified as infectious (37,39). For example, about 6% of hospital waste will be treated as infectious if the CDC Guidelines are followed (39) but 45% of hospital waste could be considered infectious under the Medical Waste Tracking Act (30).

While hospitals are considered to be the primary generator of medical waste by volume and the focus of most regulations (27,49,54), these figures capture only a fraction of the health care facilities that generate medical waste such as 180,000 physicians’ offices, 98,400 dentists’ offices, 38,000 veterinarians’ offices, 15,500 medical clinics, 12,700 long-term health care facilities, 4,300 laboratories, and 900 free-standing blood banks (57). No reliable data are available on the quantity of medical waste produced from these non-hospital health care sites. Additionally, there are 2 million diabetics and 1.2 million intravenous drug abusers nationwide who generate over 1 billion insulin-type syringes which are not regulated (57).

# Public Health Implications of Waste

## *Real Versus Perceived Health Risks*

Most proponents of medical waste legislation have claimed that medical waste poses a threat to human health and must be strictly regulated. However, the alleged “health hazards” of our current medical waste disposal practices have not been scientifically demonstrated.

Washups of floatable medical and other waste on the beaches of New Jersey and the New York area during the summers of 1987 and 1988 brought with them intensified public concern for public health and safety. While washups of floatable waste are not new, the public’s attention was caught by the seeming novelty of finding medical waste on the beaches. Because of the public’s concern with AIDS, medical waste on beaches brought a perceived threat to health and safety (2,10).

Although the issue of medical waste on beaches is a serious aesthetic and economic problem requiring immediate attention, the public health risks are virtually nonexistent. For example, the theoretical estimate that the events necessary for infection will occur in sequence and a person will develop HIV infection from a needle on the beach is 1 in 15 billion to 1 in 390 trillion (Figure 1) (1,23,40,50). Equally important, there is far less medical waste on beaches than the media led the public to believe (13,14,33,54,55). The amount of medical waste, in the form of plastic syringes, collected on the beaches of our 23 coastal states constituted less than 0.1% of the total debris found (13,14). In another study, New York and New Jersey were found to have more medical waste reported on their beaches (1% to 10% of the total debris) than the national average (33). Even though there is agreement among public health experts that the actual risks or “hazards” posed by medical waste at the beaches or in landfills are exceedingly low, the present climate in our society is that complete safety (i.e., zero risk) is a feasible goal regardless of cost. In such a climate, legislators or public health officials may respond with extreme measures. Because increased costs for the affected services are not obviously linked to the actions or laws, the system becomes tilted to overreaction (28).

**Table I. Types of Medical Waste Designated as Infectious and Recommended Disposal/Treatment Methods — CDC and EPA<sup>1,2</sup>**

Source/Type of Medical Waste	CDC		EPA		MWTA
	Infectious Waste	Disposal/Treatment Methods	Infectious Waste	Disposal/Treatment Methods	Infectious Waste <sup>5</sup>
Microbiological (e.g., stocks and cultures of infectious agents)	Yes <sup>3</sup>	S,I	Yes	S,I,TI,C	Yes
Blood and blood products	Yes	S,I,Sew	Yes	S,I,Sew,C	Yes
Pathological (e.g., tissue, organs)	Yes	I	Yes	I,SW,CB	Yes
Sharps (e.g., needles)	Yes	S,I	Yes	S,I	Yes <sup>6</sup>
Communicable disease isolation	No	–	Yes	S,I	Yes <sup>6</sup>
Contaminated animal carcasses, body parts and bedding	Yes	S,I(carcasses)	Yes	I,SW (not bedding)	Yes
Contaminated laboratory wastes	No	–	Optional <sup>4</sup>	If considered IW, use S or I	No
Surgery and autopsy wastes	No	–	Optional	If considered IW, use S or I	No
Dialysis Unit	No	–	Optional	If considered IW, use S or I	No
Contaminated equipment	No	–	Optional	If considered IW, use S or I	No

<sup>1</sup> The Joint Commission for the Accreditation of Healthcare Organizations (25) requires that there be a hazardous waste system designed and operated in accordance with applicable law and regulations.

<sup>2</sup> Abbreviations: CDC – Centers for Disease Control (11,12,22); EPA – Environmental Protection Agency (53); MWTA – Medical Waste Tracking Act (54); I – incineration; S – steam sterilization; TI – thermal inactivation; C – chemical disinfection for liquids only; Sew – sanitary sewer (EPA requires secondary treatment); SW – steam sterilization with incineration or grinding; CB – cremation or burial by mortician; IW – infectious waste.

<sup>3</sup> The CDC guidelines specify “microbiology laboratory waste” as an infectious waste. This term includes stocks and cultures of etiological agents and microbiology laboratory waste contaminated with etiologic agents (e.g., centrifuge tubes, pipettes, tissue culture bottles).

<sup>4</sup> Optional infectious waste: EPA states that the decision to handle these waste as infectious should be made by a responsible, authorized person or committee at the individual facility.

<sup>5</sup> The Act went into effect on June 22, 1989 and expired June 22, 1991. It affected only four states (New Jersey, New York, Connecticut and Rhode Island). The Act required both treatment (any method, technique or process designed to change the biological character or composition of medical waste so as to eliminate or reduce its potential for causing disease) and destruction (waste is ruined, torn apart, or mutilated so that it is no longer generally recognizable as medical waste).

<sup>6</sup> MWTA specified used and unused sharps. The Act regulated wastes from persons with highly communicable diseases such as Class 4 etiologic agents (e.g. Marburg, Ebola, Lassa).

Reprinted with permission from reference 41.

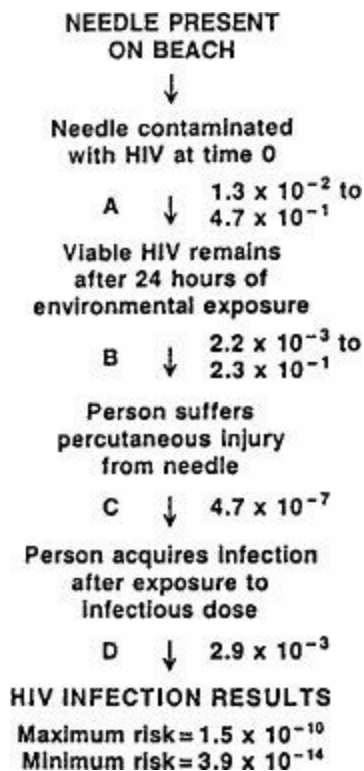

Figure 1. Theoretical Estimate of HIV Being Transmitted Via a Needle on a New York Beach

- A: Based on prevalence of HIV in sentinel hospital patients, 1.3% (50), or in New York drug abusers, 47% (29).
- B: Based on HIV degradation rates following seawater exposure (HIV viability after 24 hours, 23%) (45), or ambient air exposure (HIV viability after 24 hours, 0.22%) (36).
- C: Based on number of visits to New York beaches and reported rates of needlestick injuries, 5/10,597,000, (1).
- D: Based on risk of HIV infection following HIV contaminated percutaneous needlestick injury in health care workers, 0.29%, (23).

Reprinted with permission from reference 41.

Renn and Covello hypothesize that the public perceives the risk of medical waste as a serious threat because the potential outcome is death (e.g., from AIDS), and the pathway to infection is intuitively plausible. They also point out that several factors amplify the public's risk perception or "outrage" to include: dreaded consequence (e.g., people downplay the risk of commonplace hazards such as peanut butter or motor vehicles while exaggerating the risks of unfamiliar ones); the perception of equitable sharing of the benefits and risks (i.e., people living near a waste-disposal site rarely appreciate the benefit because they assume a larger burden of the costs); and the potential for blame (i.e., the possibility of assigning blame to a person, institution, or industry for creating a risky situation) (35). Efforts to explain a "hazard" are unlikely to succeed so long as the "outrage" is high. Risk perception researchers believe that to lessen public concern about exceedingly low "hazards," experts and public health officials must diminish the "outrage" (42,46).

Ironically, the combined forces of public opinion and federal legislation of medical waste will do little to correct the problem of beach washups or the broader issue of environmental

degradation. The real source of the problem is not correctable by tracking medical waste, by broadening the definition of medical waste, nor by regulating medical waste from hospitals and clinics. The source of the washups is much more difficult to regulate: weather patterns (i.e., prevailing winds) and currents, mechanical failures in sewage systems of coastal cities, and a failure to deal adequately with garbage disposal in general and medical waste from non-hospital health care sites and the general public in particular (10).

### *Microbiologic Quality of Hospital Waste Versus Household Waste*

On average, household waste contains more microorganisms with pathogenic potential for humans than medical waste. Several studies have quantitatively and qualitatively evaluated the microbiological content of hospital waste and household waste (Table II). In fact, several investigators have demonstrated that household waste contains, on average, 100 times more microorganisms with pathogenic potential for humans than hospital waste (4,24,26). Each of the eight studies conducted worldwide has found that household waste was, on average, more microbially contaminated than hospital waste (4,19,24,26,32,51). Household waste that may contribute to large numbers of microorganisms include facial tissues, dog and cat feces, soiled disposable diapers, and putrescible foods (34).

Kalnowski et al examined the microbial contamination and species pattern of hospital waste from a surgical department (operating unit, intensive care unit, nursing station) and household waste. Using a gentle homogenization technique, these investigators found household waste to be 10 to 100,000 times more microbially contaminated than hospital waste. In addition, common nosocomial pathogens (i.e., *Pseudomonas aeruginosa*, *Klebsiella* spp, *Enterobacter* spp, *Proteus* spp, Group D streptococci) were detected more frequently from household waste than from hospital waste (26). Kalnowski et al also summarized the results of a study by Schrammeck and Sauerwald and a U.S. Environmental Protection Agency study by Burchinal who also found the bacterial concentration of hospital waste (nursing unit, intensive care unit, operating room) similar to that reported by Kalnowski (Table II) (26).

**Table II. Bacterial Concentrations (arithmetic mean/gram) in Hospital Wastes and Household Refuse**



Authors	Group of Bacteria	Private Household	Operating Unit	Outpatient Surgery	Intensive Care Unit	Surgical Ward	Internal Medicine	OB/GYN	Laboratory
Althaus et al, 1983	Aerobic bacteria	7.2×10 <sup>6</sup>	I 1.1×10 <sup>6</sup> II 8.8×10 <sup>3</sup>	I 3.1×10 <sup>4</sup> II 2.2×10 <sup>4</sup>	I 5.7×10 <sup>5</sup>	I 3.3×10 <sup>7</sup> II 2.8×10 <sup>5</sup>	II 2.6×10 <sup>6</sup> III 2.0×10 <sup>6</sup>	I 4.3×10 <sup>4</sup> II 1.0×10 <sup>6</sup>	I 1.7×10 <sup>6</sup> II 5.3×10 <sup>6</sup>
	Coliform bacteria	8.4×10 <sup>5</sup>	I 5.3×10 <sup>5</sup> II 1.1×10 <sup>2</sup>	I 5.7×10 <sup>2</sup> II 3.1×10 <sup>4</sup>	I 3.7×10 <sup>5</sup>	I 4.2×10 <sup>5</sup> II 1.9×10 <sup>4</sup>	II 9.4×10 <sup>4</sup> III 1.2×10 <sup>5</sup>	I 6.6×10 <sup>3</sup> II 1.8×10 <sup>6</sup>	I 8.2×10 <sup>6</sup> II 1.2×10 <sup>6</sup>
	<i>E. coli</i>	1.3×10 <sup>5</sup>	I 3.3×10 <sup>5</sup> II 1.2×10 <sup>1</sup>	I 1.6×10 <sup>0</sup> II 1.8×10 <sup>5</sup>	I 3.5×10 <sup>4</sup>	I 8.0×10 <sup>4</sup> II 2.4×10 <sup>4</sup>	II 5.6×10 <sup>4</sup> III 6.9×10 <sup>4</sup>	I 3.7×10 <sup>3</sup> II 3.1×10 <sup>5</sup>	I 5.6×10 <sup>5</sup> II 1.5×10 <sup>6</sup>
Kalnowski et al, 1983	Aerobic bacteria	6.1×10 <sup>8</sup>	2.3×10 <sup>4</sup>	ND	2.2×10 <sup>6</sup>	3.4×10 <sup>8</sup>	ND	ND	ND
	Gram negative bacteria	6.0×10 <sup>7</sup>	5.8×10 <sup>3</sup>	ND	7.2×10 <sup>4</sup>	2.8×10 <sup>7</sup>	ND	ND	ND
	Streptococci Group D	1.0×10 <sup>7</sup>	0	ND	2.9×10 <sup>5</sup>	1.2×10 <sup>5</sup>	ND	ND	ND
	Facult. anaerobes	9.6×10 <sup>8</sup>	1.7×10 <sup>3</sup>	ND	2.1×10 <sup>6</sup>	2.6×10 <sup>7</sup>	ND	ND	ND
Jager et al, 1989	Total bacteria	2.5×10 <sup>8</sup>	IV 2.0×10 <sup>8</sup> V 5.0×10 <sup>5</sup>	ND	IV 3.5×10 <sup>5</sup> (S) IV 7.1×10 <sup>5</sup> (M) V 1.4×10 <sup>9</sup> (S)	IV 1.1×10 <sup>7</sup> V 1.1×10 <sup>7</sup>	IV 2.8×10 <sup>6</sup> V 7.9×10 <sup>6</sup>	ND	ND
	Streptococci Group D	1.0×10 <sup>7</sup>	IV 4.0×10 <sup>3</sup> V 4.0×10 <sup>1</sup>	ND	IV 2.0×10 <sup>3</sup> (S) IV 4.0×10 <sup>4</sup> (M) V 1.6×10 <sup>4</sup> (S)	IV 6.3×10 <sup>5</sup> V 1.0×10 <sup>6</sup>	IV 2.0×10 <sup>5</sup> V 7.9×10 <sup>4</sup>	ND	ND
	Gram negative rods	7.9×10 <sup>7</sup>	IV 6.3×10 <sup>3</sup> V 2.5×10 <sup>3</sup>	ND	IV 2.0×10 <sup>5</sup> (S) IV 5.0×10 <sup>4</sup> (M) V 2.5×10 <sup>4</sup> (S)	IV 2.0×10 <sup>6</sup> V 1.3×10 <sup>6</sup>	IV 1.3×10 <sup>6</sup> V 1.3×10 <sup>6</sup>	ND	ND
	Obligate-facult. anaerobes	2.0×10 <sup>3</sup>	IV 4.0×10 <sup>1</sup> V 1.0×10 <sup>1</sup>	ND	IV 6.3×10 <sup>2</sup> (S) IV 5.0×10 <sup>2</sup> (M) V 1.6×10 <sup>3</sup> (S)	IV 1.6×10 <sup>2</sup> V 4.0×10 <sup>2</sup>	IV 2.5×10 <sup>2</sup> V 4.0×10 <sup>2</sup>	ND	ND

Abbreviations: ND – no data; S – surgical; M – medical; facult. – facultative; I, II, III – different hospitals; IV – large hospital (1300 beds); V – small hospital (250 beds). Reprinted with permission from reference 41.1

Althaus et al analyzed 264 hospital waste samples and 21 household samples for microbial contamination. The results again showed that the microbial contamination of hospital waste was less than or similar to household waste (Table II) and, in some cases, that it was even free of microbial contamination, especially single samples of hospital waste (e.g., syringes, dressings, swabs). Qualitative methods allowed 21 pathogenic bacteria and fungi to be identified and 12 of these were found in both household waste and hospital waste (4). Mose and Reinthaler also found that household waste was more commonly contaminated, especially with fecal bacteria, and almost one-third of all hospital waste showed no bacterial contamination. Thirteen percent (19/149) of the eluates from blood-saturated refuse samples were hepatitis B surface antigen (HBsAg) positive as were 15% (155/1041) of the serum samples (32). While HBsAg is a marker for HBV, its presence does not demonstrate infectiousness since HBsAg is present in greater numbers (1000x) and is more environmentally stable than HBV. Jager et al also demonstrated that the bacterial concentration of hospital waste was less than or similar to that of household waste (Table II). The concentration of gram negative rods in household waste was, on average, 10,000 times higher than waste from the operating room (24). Trost and Filip evaluated the concentration of pathogenic microorganisms in refuse from consulting rooms of general practitioners, ear-nose-throat specialists, dermatologists, dentists, and veterinarians compared to municipal waste. They found that waste from medical consulting rooms generally had lower microbial counts as compared to municipal waste (51).

Lastly, another study compared the microbiologic contamination of trash originating from the rooms of patients on isolation precautions versus standard care. The mean log total colony forming units (cfu) per bag was 1.60 + 1.55 cfu for isolation trash and 1.97 + 1.83 cfu (p=.44) for non-isolation trash. Contamination by *Staphylococcus aureus*, *Escherichia coli*, and *P. aeruginosa* was comparable in both groups but contamination with enteroviruses was significantly higher

in non-isolation bags. These results suggest that the types and numbers of organisms in trash generated from isolation and non-isolation are comparable (58).

We can deduce from our daily exposure to household waste and the decades of sanitary landfill burial that the public health risks for the less microbially contaminated hospital waste are nominal.

### *Public Health and Occupational Risks*

There is no evidence that a member of the public or a waste industry worker has ever acquired an infection from medical waste. The only medical waste which has been associated with infectious disease transmission is contaminated sharps (1). All reports of transmission of infectious agents by contaminated sharps describe occurrences in the health care setting during patient care, laboratory procedures, or sharps disposal and not associated with environmental injuries which occurred after extramural disposal (1). There is no epidemiological evidence that hospital waste disposal practices have caused disease in the community (1,38,39). Further, occupational exposure of waste industry workers to medical and municipal waste has not been found to lead to an increased risk of acquiring bloodborne infections (1,15,18). For example, Cimino reported on the disease and injury data over a 2-year period (1968-1969) for the 14,000 persons employed by the New York Department of Sanitation. He found a higher overall injury rate than other industrial occupations but no case of hepatitis developed in the group suffering needle punctures (15).

### *Infection Risks Associated with Treatment Technologies*

There are no infectious risks associated with any type of medical waste treatment method. Treatment of regulated medical waste by U.S. hospitals is most commonly accomplished by incineration (range 64%-93% by type of waste). About one-third of U.S. hospitals steam sterilize their microbiological waste and about one-fourth pour liquid blood down the drain connected to a sanitary sewer (WA Rutala, unpublished results). Non-regulated medical waste is discarded via a sanitary landfill (37).

None of these treatment or disposal procedures represent an infectious health hazard. For example, properly-operated incinerators produce a sterile ash (6,9), there is no difference between bacteria in stack emissions and ambient air (56), and when *Bacillus subtilis* is mixed with waste it is inactivated (3).

While most states have prevented sanitary landfill disposal of regulated medical waste, data suggest that untreated medical waste can safely be disposed of in sanitary landfills provided procedures to prevent worker contact with this waste during disposal are employed (1). Presumably the reason for excluding medical waste from landfills has been concern that pathogenic microorganisms might persist in and move through landfilled solid waste, become part of the leachate produced and enter the surrounding environment (i.e., ground and nearby surface waters), and result in human exposure and disease through ingestion of leachate-contaminated waters. Several laboratory and field studies on the survival and transport of pathogenic microorganisms in solid waste and its leachate found that enteric viruses and bacteria are largely adsorbed and inactivated in landfilled solid waste, are present in leachates

at relatively low concentrations, and are unlikely to migrate through soils into groundwater (MD Sobsey, written communication; 16,17,21,34,47,48). These studies were confirmed by the failure to detect enteric viruses in leachates from 21 landfills in the U.S. and Canada which represented a wide range of conditions with regard to solid waste landfill practice, geography, soil, and climate (48). There is also no evidence that waterborne outbreaks of disease caused by enteric microbes are because of municipal solid waste landfills or their leachates (34).

As previously noted, municipal solid waste contains, on average, more microorganisms with pathogenic potential for humans than medical waste and yet there are no restrictions on placing municipal waste into landfills. However, use of sanitary landfills for medical waste is not a viable long-term alternative since landfills are unavailable or reaching capacity in some areas (7).

There is also some concern about blood being discarded via a drain connected to a sanitary sewer. This concern is unwarranted for several reasons. First, conventional treatment processes of sewage such as primary sedimentation, secondary (biological) treatment, and effluent disinfection are designed to reduce the microbial content of raw sewage by 90% to 99% depending upon the type of microorganisms and specific treatment processes (8). Second, the microbial load added to the sewer via the usually sterile body fluid, blood, is negligible compared to major sources of pathogenic microbes in sewage which include the bacteria and viruses in human feces which exceed  $10^{10}$  gram (34). Third, blood discharge into the sanitary sewer system by hospitals is diluted to a very low concentration by the enormous amounts of effluent from hospitals and residences. Fourth, no bloodborne disease risks from occupational exposure to sewage have been described (34,44).

### *Non-Infectious Risks Associated with Treatment Technologies*

There are no demonstrated non-infectious health risks associated with waste treatment technologies which are currently employed; however, public health concerns regarding treatment technologies require further investigation and subsequent development of scientifically-based standards. The health risks associated with the incineration of medical waste continue to be debated due to the paucity of data. The pollutants of primary concern from both hospital and municipal waste incinerators include dioxins and furans (some of which are suspected carcinogens), acid gases (e.g., hydrogen chloride), metals (e.g., lead, mercury, cadmium), and particulate emissions (which may absorb heavy metals and organics and serve as irritants). Some of these substances (e.g., heavy metals, dioxins, furans) can also be a constituent of incinerator ash (52). Preliminary studies using the Ames *Salmonella typhimurium* assay indicate that stack fly ash and particulate emissions from medical waste incinerators are less mutagenic than emission estimates published for wood stoves, automobile gas engines, and residential furnaces (20). However, the public health concerns of chemicals in the emissions or ash require further investigation which should lead to the development of scientifically-based standards.

Currently, statewide moratoriums or stringent rules (particularly air emission) and permit requirements make it virtually impossible for hospitals to install incinerators and difficult for hospitals to use installed incinerators. Health facilities in New York are adjusting to strict new

incineration standards that took effect January 1, 1992 and may close about 75% (220/300) of the health facility incinerators, while New Jersey's incineration standards have forced most health facilities to close their incinerators or pay fines of \$5,000 per month (5). This results in increased disposal costs for the shipment of regulated medical waste sometimes long distances to regional incinerators.

Documented health risks from steam sterilization do not exist. Potentially, workers could be exposed to aerosolized organic solvents or other hazardous chemicals if these materials were autoclaved and the workers were exposed to the vented steam. This potential emission problem can be prevented by not auto-claving hazardous chemicals (52).

The health risk associated with new alternative technologies (e.g., microwave, gamma radiation, infrared) requires further examination. When an alternative waste treatment technology is considered, any new (e.g. gamma radiation exposure) or additional employee exposures that could result from the new methods should be identified and evaluated (52).

### *Infection Risks Associated with Recycling Hospital Waste*

There are no infectious risks associated with recycling hospital waste. Effective management of hospital waste incorporates a waste reduction and recycling component where appropriate. Presently, recycling efforts by hospitals have generally focused on nonpatient contact sources of waste such as glass, scrap metal, aluminum cans, cardboard, and packaging material (31). Although there are no infection risks posed by recycling these components of the hospital waste stream, reports of hospitals being unable to market certain items for recycling (e.g., glass intravenous bottles) because they are perceived to be "infectious/medical waste" have occurred. This highlights the need for better understanding of the actual public health risks posed by the medical waste stream. From an infectious disease perspective, all materials generated in the health care setting are possible candidates for recycling (52).

### *MWTA Costs and Benefits*

The cost of complying with the Medical Waste Tracking Act is much higher than EPA estimates and there is no demonstrable environmental benefit. A key component in evaluating the impact on cost of a medical waste management program is the quantity of infectious waste produced per patient. As stated, the percent of medical waste treated as infectious increases with the number of types of medical waste classified as infectious. For example, utilizing the CDC guidelines, about 6% of hospital waste will be treated as infectious (39). In contrast, a New York university hospital and university reported that 45% of its waste was designated as regulated medical waste (or infectious waste) to be in compliance with the MWTA (30). This occurs because some of the waste listed in the MWTA are included because they are aesthetically displeasing to the public. Additionally, the terminology associated with some waste categories is nebulous such as "items saturated and/or dripping with human blood." This wording can lead state and federal inspectors to inappropriately consider any items tinged with blood as regulated medical waste. Since it might be difficult to maintain separate waste containers for regulated and non-regulated medical waste in a manner which ensures no confusion in certain patient care areas (e.g., operating room, emergency room), facilities would

be forced to designate all waste generated in these areas as regulated medical waste. Additionally, hospitals overdesignate waste as regulated medical waste because the penalties for violating the MMTA rules are so severe. With the exception of pathological waste, the use of aesthetics as a criterion to regulate medical waste establishes a controversial precedent and reinforces the public's perception that more of this waste has an infectious potential than is true (52). It also increases hospitals' waste disposal costs significantly more than the EPA estimate of \$3757 per hospital per year (54).

To illustrate, a New York university hospital and university reported that, in order to comply with the MMTA, the amount of regulated medical waste generated increased 315% from 1984 (443,000 pounds) to 1989 (1,837,000 pounds), their total cost increased from \$106,000 to \$835,000 per year or nearly 700%, and the cost per patient per day for regulated medical waste went from \$1.04 to \$5.19 (30). This is largely due to considering a greater portion of medical waste as regulated medical waste and to the cost differential between disposing of non-regulated medical waste (i.e., \$0.02-0.05 per pound) compared to regulated medical waste (i.e., \$0.20-0.60 per pound). Other hospitals such as Yale-New Haven Hospital in Connecticut have also documented soaring costs under the MMTA (43). Based on the New York hospital data and patient census data from the American Hospital Association, it would cost U.S. hospitals about \$1.3 billion a year to comply with the MMTA. This is approximately seven times the amount allotted (\$182 million) by the federal government in 1991 for all childhood immunizations. Ultimately, this additional cost will likely be passed on to the public in the form of higher medical fees, insurance rates, and/or taxes.

It should be noted that while the principal purpose of the MMTA was to reduce medical waste on beaches, it has not demonstrated its intended benefit. The number of syringes on the beaches in the MMTA states was significantly greater during implementation of the act (644/3738 – 17.23%) than before the act went into effect (55/1718 – 3.2%) (Table III). There was no relative increase in the total number of syringes on the beaches in the 23 coastal states before and during implementation of the MMTA (Table III) (13,14,55). This may substantiate some concerns that strict and expensive requirements for medical waste may promote mismanagement by unscrupulous generators, processors, and haulers.

**Table III. Number of Syringes Collected on Beaches Before (1988) and During (1990) Implementation of Medical Waste Tracking Act<sup>1</sup>**

States	Number of Syringes in State/Total Syringes in 23 Coastal States		
	Before MMTA – 1988 (3)	During MMTA – 1990 (4)	p value <sup>2</sup>
Connecticut	0/1718 (0%)	142/3738 (3.80%)	<.001
New Jersey	11/1718 (0.64%)	152/3738 (4.07%)	<.001
New York	33/1718 (1.92%)	291/3738 (7.78%)	<.001

Single user license provided by AAMI. Further copying, networking, and distribution prohibited.

Rhode Island	11/1718 (0.64%)	59/3738 (1.58%)	0.004
Total in MWTA States	55/1718 (3.2%)	644/3738 (17.23%)	<.001
Total Syringes on Beaches in 23 Coastal States/Total Items on Beaches in 23 Coastal States	1718/1,973,995 (0.09%)	3738/4,227,791 (0.09%)	0.601

<sup>1</sup> Medical Waste Tracking Act went into effect on June 22, 1989 and affected only four states (New York, New Jersey, Connecticut and Rhode Island). It expired on June 22, 1991. Sharps (syringes or needles) constituted about 65% of medical waste that washed ashore in the summer of 1988 (55).

<sup>2</sup> p values by Fisher's exact test.

Reprinted with permission from reference 41.

# Conclusion

The hasty promulgation of unscientific regulations for transport and disposal of medical waste should be replaced with the development of uniform regulations based on scientific data for proper decontamination and disposal of the very small amount of medical waste that may pose an infectious hazard. Additionally, an intensive public education program regarding the actual risks posed by medical waste and methods for their proper management may reduce the public's outrage. This approach may prevent the wasteful expenditure of precious health care resources and would safeguard the environment and the public's health.

# References

1. Agency for Toxic Substances and Disease Registry. The public health implications of medical waste: A report to Congress. Public Health Service, U.S. Department of Health and Human Services, September 1990.
2. American Hospital Association. Shaping state and local regulation of medical waste and hazardous materials. Ad Hoc Committee on Medical Waste and Hazardous Materials. Chicago, Illinois, May 1990.
3. Allen RJ, Brenniman GR, Logue RR, Strand VA. Emission of airborne bacteria from a hospital incinerator. *J Air Pollution Control Assoc* 1989;39:164-168.
4. Althaus H, Sauerwald M, Schrammeck E. Hygienic aspects of waste disposal. *Zbl Bakt Mikr Hyg, I Abt Orig B* 1983;178:1-29.
5. Anonymous. New NY standards to close 220 or more waste incinerators. *Health Facilities Management*. July 1991; 8.
6. Barba PD. Test results from bacterial sample bums from nine infectious waste incinerators. Mid-Atlantic Air Pollution Control Association Meeting, November 1987, Atlantic City, NJ.
7. Beck M. Buried alive. *Newsweek*, November 27, 1989; 66-71, 75, 76.
8. Bitton G. *Introduction to Environmental Virology*. New York: John Wiley and Sons; 1980; 121-152.
9. Blenkharn JI, Oakland D. Emission of viable bacteria in the exhaust of flue gases from a hospital incinerator. *J Hosp Infect* 1989;14:73-78.
10. Burdick A. Hype tide. *The New Republic* June 12, 1989; 15-18.
11. Centers for Disease Control. Recommendations for prevention of HIV transmission in health-care settings. *MMWR* 1987;36:2S-18S.
12. Centers for Disease Control — National Institutes of Health. *Biosafety in Microbiological and Biomedical Laboratories*. In: Richardson JH, Barkley WE, eds. Washington, DC: U.S. Department of Health and Human Services, May 1988. HHS Publication No. (NIH) 88-8395.
13. Center for Marine Conservation (written by KJ O'Hara): *Trash on America's Beaches: A National Assessment*. Washington, DC: Center for Marine Conservation, July 1989.
14. Center for Marine Conservation (written by P Debenham and LK Younger): *Cleaning North America's Beaches, 1990 Beach Cleanup Results*. Washington, DC: Center for Marine Conservation, May 1991.
15. Cimino JA. Health and safety in the solid waste industry. *Am J Publ Health* 1975;65:38-46.
16. Cooper RC, Potter JL, Leong C. Virus survival in solid waste treatment systems. In: Malina JF Jr, Sagik BP, eds. *Virus Survival in Water and Wastewater Systems*. Austin: University of Texas at Austin; 1974; 218-232.
17. Cooper RC, Potter JL, Leong C. Virus survival in solid waste leachates. *Water Research* 1975;9:733-739.
18. Corrao G, Zotti C, Sciacovelli A, Bosia S, Piccioni P. Hepatitis A and B virus infections in garbage collectors from Asti. *J Ital Med Lav* 1985;7:145-147.
19. Donnelly JA, Scarpino PV. Isolation, characterization and identification of microorganisms from laboratory and full-scale landfills. Cincinnati, Ohio: U.S. Environmental Protection



Agency, Municipal Environmental Research Laboratory, Office of Research and Development, 1984. Publication No. (EPA) 600/2-84-119.

20. Driver JH, Rogers HW, Claxton LD. Mutagenicity of combustion emissions from a biomedical waste incinerator. In: *Proceedings of the 1989 Incineration Conference*, University of California, Irvine; 1989; 5.5.1-5.5.11.
21. Engelbrecht RS, Weber MJ, Amirhor P, Foster DH, LaRossa D. Biological properties of sanitary landfill leachate. In: Malina JF Jr. and Sagik BP, eds. *Virus Survival in Water and Wastewater Systems*, Austin: University of Texas at Austin; 1974; 201-217.
22. Garner JS, Favero MS. Infective waste, Guideline for Handwashing and Hospital Environmental Control, Atlanta: Centers for Disease Control, 1985.
23. Henderson DK, Fahey BJ, Willy M, et al. Risk for occupational transmission of human immunodeficiency virus type 1 (HIV-1) associated with clinical exposures. *Ann Intern Med* 1990;113:740-746.
24. Jager E, Xander L, Ruden H. Hospital wastes. 1. Communication: Microbiological investigations of hospital wastes from various wards of a big and of smaller hospital in comparison to household refuse. *Zbl Hyg* 1989;188:343-364.
25. Joint Commission on Accreditation of Healthcare Organizations. Standard: Hazardous Materials and Wastes, In: *Accreditation Manual for Hospitals*. Chicago, Illinois; 1990; 197.
26. Kalnowski G, Wiegand H, Ruden H. The microbial contamination of hospital waste. *Zbl Bakt Mikr Hyg, I Abt Orig B* 1983;178:364-379.
27. Karpiak J, Pugliese G. Medical waste — Declining options in the 90's. *Am J Infect Control* 1991;19:8-15.
28. Koshland DE Jr. Scare of the week. *Science* 1989;244:9.
29. Lee HH, Weiss SH, Brown LS, et al. Patterns of HIV-1 and HTLV-I/II in intravenous drug abusers from the middle atlantic and central regions of the USA. *J Infect Dis* 1990;162:347-352.
30. Marchese JT, Marshall GB, LaValle RF, Greene WH. Regulated medical waste disposal at a university and university hospital: future implications. Third International Conference on Nosocomial Infections. Abstract B/47, August 1990.
31. Minnesota Hospital Association. The MHA recycling and conservation guide. Minnesota Hospital Association, 1990; 1-28.
32. Mose JR, Reinthaler F. Microbial contamination of hospital waste and household refuse. *Zbl Bakt Mikr Hyg, I Abt Orig B* 1985;181:98-110.
33. New York State Department of Environmental Conservation Report. Investigation: Sources of Beach Washups in 1988. Albany, New York, 1988.
34. Pahren HR. Microorganisms in municipal solid waste and public health implications. *CRC Critical Reviews in Environmental Control* 1987;17:187-228.
35. Renn O, Covello V. Medical Waste: Risk perception and communication. In: Stewart TR, Curran TP, de Alteriis M, Mumpower JL, Svitek LL, eds. *Perspectives on Medical Waste*. New York: The Nelson A. Rockefeller Institute of Government; 1989; VII.1-VII.21.
36. Resnick L, Veren K, Salahuddin SZ, Tondreau S, Markham PD. Stability and inactivation of HTLV-III/LAV under clinical and laboratory environments. *JAMA* 1986;255:1887-1891.
37. Rutala WA, Sarubbi FA. Management of infectious waste from hospitals. *Infect Control*

1983;4:198-204.

38. Rutala WA. Infectious waste—a growing problem for infection control. *Asepsis* 1987;9: 2-6.
39. Rutala WA, Odette RL, Samsa GP. Management of infectious waste by US hospitals. *JAMA* 1989;262:1635-1640.
40. Rutala WA, Weber DJ. Infectious waste — mismatch between science and policy. *N Engl J Med* 1991;325:578-582.
41. Rutala WA, Mayhall CG, The Society of Hospital Epidemiology of America. Medical Waste. *Infect Control Hosp Epidemiol* 1992;13:38-48.
42. Sandman PM. Hazard versus outrage: How the public sees environmental health risk. Association of State and Territorial Health Officials Annual Meeting Highlights, Vail, Co. April 4-7, 1989; 18.
43. Sedor PM. Costs soar under EPA's waste tracking program. *Health Facilities Management* June 1990; 24, 26-28, 30.
44. Skinhoj P, Hollinger FB, Hovind-Hougen K, Lous P. Infectious liver diseases in three groups of Copenhagen workers: Correlation of hepatitis A infection to sewage exposure. *Arch Environ Health* 1980;36:139-143.
45. Slade JS, Pike EB, Eglin RP, Colbourne JS, Kurtz JB. The survival of human immunodeficiency virus in water, sewage and sea water. *Water Sci Technol* 1989;21:55-59.
46. Slovic P. Perception of risk. *Science* 1987;236:280-285.
47. Sobsey MD, Wallis C, Melnick JL. Studies on the survival and fate of enteroviruses in an experimental model of a municipal solid waste landfill and leachate. *Appl Microbiol* 1975;30:565-574.
48. Sobsey MD. Field survey of enteric viruses in solid waste landfill leachates. *Am J Public Health* 1978;68:858-864.
49. State Infectious Waste Regulatory Program. Lexington: Council of State Governments, 1988.
50. St. Louis ME, Rauch KJ, Petersen LR, et al. Seroprevalence rates of human immunodeficiency virus infection at sentinel hospitals in the United States. *N Engl J Med* 1990; 323:213-218.
51. Trost M, Filip Z. Microbiological investigations on refuse from medical consulting rooms and municipal refuse. *Zbl Bakt Hyg, I Abt Orig B* 1985;181:159-172.
52. U.S. Congress. Office of Technology Assessment, Finding the Rx for Managing Medical Wastes, OTA-0-459. Washington, DC: U.S. Government Printing Office, September 1990.
53. U.S. Environmental Protection Agency: Guide for Infectious Waste Management. Washington, DC, 1986. Report EPA/530-SW-86-014.
54. U.S. Environmental Protection Agency. Standards for the tracking and management of medical waste; interim final rule and request for comments. *Federal Register* March 24, 1989;54:12326-12395.
55. U.S. Environmental Protection Agency. Inventory of Medical Waste Beach Wash-ups, June-October 1988. Fairfax, VA: ICF Incorporated; March 1989.
56. U.S. Environmental Protection Agency. Summary of potential risks from hospital waste incineration: Pathogens in air emissions and residues. Washington, DC; April 1989.
57. U.S. Environmental Protection Agency. Medical waste management in the United States:

First interim report to Congress. May 1990. Report No. EPA/530-SW-90-051A.

58. Weinstein S, Kotilainen HR, Moore D, Gantz N. Microbiologic contamination of hospital trash from patients on isolation precautions versus standard care. *Am J Infect Control* 1988;16:76.

---

<sup>1</sup> This correspondence was adapted with permission from articles published in the *New England Journal of Medicine*, 1991;325:578-582 and *Infection Control and Hospital Epidemiology*, 1992; 13: 38-48.



# **Fungal Infections in Immunocompromised Hosts, Particularly Among Cancer Patients**

**Françoise Meunier, M.D., Ph.D.**

*European Organization for Research and Treatment of Cancer, Belgium*

# Introduction

Infections remain major complications in immunocompromised hosts, and among all opportunistic pathogens, fungi are an increasing source of morbidity and mortality (21,38). Numerous factors predispose immunocompromised patients to fungal infections, including intensive antineoplastic chemotherapy, multiple courses of antimicrobial therapy, indwelling intravenous catheters for prolonged periods, corticosteroids, and various aggressive diagnostic and therapeutic procedures such as organ transplantation. Patients with AIDS represent another group at risk, as do patients hospitalized in intensive care units.

Although considerable progress has been made in the management of severe underlying diseases, these therapeutic modalities are resulting in an increased risk of opportunistic fungal infections among numerous groups of patients (36). Life-threatening infections caused by various species of *Candida* or *Aspergillus* have been well documented in immunocompromised hosts. More recently, however, unusual fungal pathogens have been isolated in similar circumstances and organisms previously considered as contaminants are currently reported to be responsible for deep-seated infections (2).

The prognosis of invasive fungal infection is still poor and optimal management remains a controversial issue. Accurate diagnosis is usually difficult to establish early in the evolution of the infection. Numerous studies are presently underway to improve diagnostic procedures, as well as prophylactic and therapeutic treatments, for those patients at risk of fungal infections.

# Diagnosis of Fungal Infections: A Challenge

Early diagnosis of invasive fungal infections remains difficult to establish. Definite proof of deep tissue infection should rely upon histology; however, invasive procedures, such as lung, liver, or kidney biopsies, are often precluded in high risk patients due to their poor conditions and the risk of hemorrhage and/or respiratory failure.

Cultures of clinical specimens, especially cerebrospinal fluid (CSF), blood, and deep tissues are useful, although the clinical significance of a positive sputum or bronchoalveolar lavage culture for *Candida* spp remains controversial. The distinction between colonization and infection is a considerable challenge for clinicians, in particular for candidiasis. On the other hand, a positive bronchoalveolar lavage culture for *Aspergillus* in the appropriate clinical setting is highly suggestive of invasive aspergillosis and requires the initiation of antifungal therapy.

Surveillance cultures are useful for epidemiological studies as well as to monitor the emergence, and/or the selection of, pathogenic fungal strains, particularly in patients receiving new antifungal agents. Moreover, surveillance cultures have been shown to be predictive of infection for some pathogenic yeasts, such as *Candida tropicalis*, as well as for *Aspergillus* spp and other unusual pathogens, including *Fusarium* spp and *Trichosporon* spp.

Most patients predisposed to invasive fungal infections are immunocompromised and therefore lack specific antibodies to combat these infections early in the evolution (8). Serodiagnosis has been very useful for cryptococcal meningitis, particularly in AIDS patients, due to the high inoculum observed in these patients. Detection of cryptococcal antigen is a highly sensitive and specific test for meningitis but unfortunately, such antigen (or metabolite) determinations are not yet commercially available for candidiasis, aspergillosis, or other types of invasive fungal infections.

# Candidiasis

Candidiasis most often results from endogenous sources such as yeast proliferation in the gastrointestinal tract and less commonly on the skin, although intravenous indwelling catheters are a major source of *Candida* infection, and epidemics related to cross contamination from medical personnel have been observed in several units (28).

Numerous clinical presentations of candidiasis have been described (9,22,37). Disseminated candidiasis resulting from hematogenous spread represents a particularly severe complication that is primarily observed in granulocytopenic patients, and specific diagnosis of invasive candidiasis is often delayed. Documented fungemia is a relatively rare event, even in patients with autopsy-proven disseminated infection and the clinical significance of a positive blood culture for yeasts is still difficult to ascertain. Occasionally, transient and self-limiting fungemia (e.g., catheter-related) occurs in patients with cancer. However, for most patients, the prognosis of fungemia is poor. A single positive blood culture for yeasts should be considered in all immunocompromised patients and antifungal therapy should be initiated pending further evaluation. We have not observed a difference in the prognosis of cancer patients with one or more positive blood cultures for yeasts (26). Moreover, severe delayed complications, such as arthritis, osteomyelitis, or endophthalmitis, have also been occasionally reported after so called transient or occult fungemia (18).

The clinical presentation of invasive candidiasis is most often nonspecific and all febrile patients should be considered at risk, particularly if they are granulocytopenic.

*Candida esophagitis* is often suspected on a clinical basis but definite diagnosis requires histological proof of invasion. X-ray findings are nonspecific of mycotic esophagitis and do not allow the differentiation of esophagitis caused by *Candida* spp or by *Herpes simplex*.

The clinical presentation of focal hepatic candidiasis, a newly recognized entity, is rather characteristic; this syndrome has been observed mainly in patients with hematologic malignancy developing fever, malaise, gastrointestinal disturbances with diarrhea, and altered liver function tests (increased alkaline phosphatase and GGT). Those manifestations usually occur when the patient has recovered adequate granulocyte counts. Ultrasonograms of the liver and hepatosplenic CT scans are useful to demonstrate multiple abscesses. Various species of yeasts or filamentous fungi are responsible for identical clinical syndromes.

During the last ten years, there has been an increased incidence of documented candidiasis caused by *Candida* spp other than *C. albicans*, in particular, *C. tropicalis*, *C. krusei*, and *Torulopsis glabrata* (13,15,18,20,26,40,41). Skin emboli seem to occur frequently if the infection is caused by *C. tropicalis*, but they have also been observed in patients with fungemia caused by *C. albicans*, *C. krusei*, and *C. parapsilosis*. Such cutaneous manifestations usually confer a worse prognosis.



# Aspergillosis

Invasive aspergillosis is also a frequent complication in patients with cancer (6,11,21). This infection is localized mainly to the lungs, but other common sites of infection include the central nervous system, liver, spleen, and the extremities, resulting from hematogenous dissemination and causing necrosis of tissues due to emboli. A classic life-threatening complication encountered in patients with pulmonary aspergillosis consists of massive hemoptysis. Besides the lungs, insertion sites of central venous catheters and craniofacial sinuses are also potential primary foci of infection.

Common clinical findings reported in patients with pulmonary aspergillosis include thoracic pain, cough, and high fever. Pulmonary infiltrates are not always present, especially early in the evolution. In suspected cases, recent improvements have been made in the diagnosis of aspergillosis using routine thoracic CT scans, even in the absence of a positive chest x-ray.

The management of invasive aspergillosis is still extremely difficult and the prognosis is usually poor in the absence of recovery of normal white blood cell counts. However, early institution of aggressive therapeutic modalities (5,14) seems to result in an improved prognosis.

# Infections Caused by Other Fungi

Invasive fungal infections caused by *Cryptococcus neoformans* are a major complication in AIDS patients but are less common in cancer patients, occurring mainly in those with altered cell-mediated immunity. The source of *C. neoformans* seems to be the air and acquisition of the pathogen results from inhalation. The classic site of infection is the central nervous system with meningitis being the most common clinical presentation, but a significant number of patients with cryptococcal meningitis have intracerebral lesions.

Common clinical findings include fever and neurological defects. In some cases, however, the absence of fever has been observed despite cryptococcal meningitis. Headache, nausea and vomiting, confusion, and mental changes are commonly reported. Occasionally, these neurological manifestations are mild or even absent. Cryptococcal meningitis has been documented despite minimal changes in the CSF and ventriculitis in the absence of a positive lumbar CSF culture.

During the last decade, several unusual fungi, previously considered contaminants, have been reported as the offending pathogens in cancer patients. These organisms include *Fusarium* spp, *Trichosporon* spp, *Pseudoallescheria boydii*, and others. Patients receiving intensive antineoplastic chemotherapy, including those undergoing bone marrow transplantation, have been shown to be at risk of developing such opportunistic infections. The clinical presentation of these complications does not vary significantly from that described above for more common fungal pathogens. However, it is important to correctly identify these unusual fungi because of the potential resistance of some of these pathogens to commonly used antifungal agents such as amphotericin B.

Finally, other mycoses such as histoplasmosis, coccidioidomycosis, etc., have to be considered according to epidemiological factors and the patient's history.

# Current Antifungal Therapy for Invasive Fungal Infections

## *Amphotericin B*

There are still few commercially available agents to treat documented invasive fungal infections and amphotericin B remains the drug of choice for most fungal pathogens. However, this compound is poorly water soluble and therefore is administered as a complex to deoxycholate (Fungizone<sup>®</sup>). Therapy with this agent is associated with numerous side effects such as fever, chills, hyper- or hypotension, and cardiac arrhythmia. Immediate side effects observed with the administration of Fungizone<sup>®</sup> are usually well controlled with either corticosteroids, meperidine, or ibuprofen. Another potentially limiting factor is nephrotoxicity.

Whether a high risk patient requires the initiation of antifungal therapy remains a difficult decision for the clinician. Moreover, the optimal duration of therapy as well as the optimal total dosage of amphotericin B are still controversial topics. The potential benefit of treatment on alternate days is interesting, although there are questions concerning the optimal duration of infusion of amphotericin B. Administration within less than 1 hour is not recommended; however, prolonged administration (over 4 hours) does not seem mandatory either.

It is well recognized that transient candidemia does not necessarily require prolonged antifungal therapy. However, due to the potentially severe delayed complications of fungemia such as endophthalmitis, arthritis, and endocarditis, any patient with documented fungemia should receive a course of antifungal therapy. Whether a total dose of 250 mg (for an adult) is effective in this specific indication or whether a higher dose is needed is still unanswered, particularly if the infection is catheter-related and the catheter has been removed.

*Candida esophagitis* is usually well controlled with a 10-day course of low-dose (0.3 mg/kg/day) amphotericin B. Disseminated candidiasis, on the other hand, is rapidly fatal and therapy with at least 1 to 2 g (total dose for an adult) of amphotericin B appears to be necessary; progress has been made and the current attributable mortality rate after fungemia has decreased from 90% to 40% (26,39).

As far as invasive aspergillosis is concerned, most adult patients should probably receive at least 1.5 g of amphotericin B unless there is a rapid recovery of adequate granulocyte counts. However, in most cases, the prognosis of invasive aspergillosis is still extremely poor.

During the last decade, anecdotal case reports and few limited clinical studies have pointed out the potential emergence of yeast strains resistant to amphotericin B (19,29). This is of particular concern in units where hematological patients are hospitalized and where chemoprophylaxis with polyenes is a common clinical practice. A few additional unusual fungi, including *P. boydii*, *Fusarium* spp, and *Trichosporon* spp, have been reported to be occasionally responsible for invasive infection in cancer patients and are known to be more resistant to amphotericin B (2).

## *Amphotericin B Plus 5-Fluorocytosine*

The antifungal agent, 5-fluorocytosine, is commonly used, although due to the rapid emergence of resistant fungal strains, it should never be used alone except in very few limited indications such as urinary tract infections. 5-fluorocytosine has been associated with several

side effects including nausea, vomiting, occasional gastrointestinal perforation, diarrhea, and bone marrow toxicity, particularly in patients with renal dysfunction. The monitoring of serum levels of 5-fluorocytosine should be performed and concentrations should not exceed 100 µg/mL in order to avoid dose-dependent bone marrow toxicity.

Large studies have reported the benefit of amphotericin B plus 5-fluorocytosine in cryptococcal infections. The potential value of the combined regimen of amphotericin B plus 5-fluorocytosine has also been suggested for granulocytopenic patients with infections caused by *C. tropicalis* (13) but there are no large randomized studies yet available to support these preliminary data.

Recent progress has been achieved with more aggressive therapeutic management of invasive aspergillosis using the combination of high daily doses of amphotericin B plus 5-fluorocytosine in febrile granulocytopenic patients with pulmonary lesions detected by CT (14). However, the specific role of 5-fluorocytosine is unclear for the therapy of aspergillosis and one must be concerned about worsening bone marrow suppression resulting from 5-fluorocytosine.

Additionally, patients with hematological malignancy often require multiple courses of antineoplastic chemotherapy which represent a real challenge for those patients with previously documented invasive aspergillosis. Routine administration of amphotericin B plus 5-fluorocytosine during each additional course of antileukemia therapy has been advocated for these patients (14) and appears to be a prudent approach but itraconazole could be a safe alternative and is presently under investigation.

### *Ketoconazole*

The imidazoles have been extensively investigated as antifungal agents during the last decade. Ketoconazole has been shown to be highly effective in chronic mucocutaneous candidiasis as well as in oropharyngeal candidiasis both for patients with cancer or AIDS. However, its potential as a therapeutic agent for invasive candidiasis is still controversial, particularly for granulocytopenic patients, and it appears to lack efficacy for the *Aspergillus* spp. Great individual variation in the absorption of ketoconazole is a major concern, especially in immunocompromised patients treated frequently with cimetidine or antacids, since both of these drugs are known to decrease absorption of ketoconazole.

## Recent Developments and Future Perspectives

Therapies available for intravenous administration offer considerable advantage in the treatment of potentially life-threatening infections in debilitated patients for whom compliance with oral administration is a major problem. Among the newly developed antifungal agents, two agents (both triazoles) have been extensively investigated.

Fluconazole is a water soluble agent with predictable pharmacologic parameters. Its absorption is not impaired by food or by antacids, and its prolonged half-life allows for once daily administration. Fluconazole is excreted in the urine and a dose reduction is mandatory in patients with impaired renal function. An interaction with cyclosporine A has been observed, but to a much lesser extent than for ketoconazole. Fluconazole is available for oral and intravenous administration and is highly effective for yeast infections, such as oropharyngeal candidiasis and cryptococcosis (35), but limited experience is available so far among granulocytopenic patients (24).

Fluconazole is presently being investigated as an alternative treatment for fungemia. Preliminary data, mainly in non-granulocytopenic patients, are encouraging. Treatment of hepatosplenic candidiasis is extremely difficult, prolonged, and compromises further administration of antineoplastic agents. Fluconazole has been investigated in this circumstance with success, and has been found to be a safe and effective alternative to amphotericin B for this clinical syndrome (3).

Itraconazole, another triazole, is also undergoing extensive evaluation and appears more effective than other azoles in treating *Aspergillus* spp. It is poorly water soluble, however, and no intravenous preparation is available to date. Serum concentrations for itraconazole are relatively low (100 ng/mL) and difficult to predict. Its absorption is affected by food and antacids. Therefore, monitoring of serum concentrations may be useful, particularly in patients undergoing bone marrow transplantation. Only limited data are presently available comparing itraconazole and amphotericin B in invasive aspergillosis, although preliminary reports are encouraging (7). Whether itraconazole is as effective as amphotericin B plus 5-fluorocytosine to prevent reactivation of aspergillosis in patients requiring further antineoplastic chemotherapy should also be established.

Numerous questions remain to be addressed concerning the role of itraconazole for patients with documented candidiasis, in particular, for invasive candidiasis among granulocytopenic patients.

Finally, besides the interest of pharmaceutical companies to develop new classes of antifungal agents, extensive research is ongoing to investigate new modalities to administer amphotericin B without inducing the major problems related to Fungizone®. This research consists mainly in the incorporation of amphotericin B into liposomes or other lipid vehicles (16,23). These studies have already shown promise and several new galenic preparations of amphotericin B have been extensively investigated (16,17,32), including two "artisanal" preparations of ampholiposomes and another formulation (25) already commercially available in some countries (Ambisome). Other formulations developed by pharmaceutical companies currently under investigation include ABLC (amphotericin B liquid complex) and ABCD (amphotericin B colloidal dispersion).

The results of available studies indicate that the pharmacological parameters of these amphotericin B preparations vary with the lipid composition and the size of the vesicles. All clinical studies performed to date show an excellent tolerance of patients receiving amphotericin B incorporated in liposomes or in other lipid vehicles, even when a high daily dose of amphotericin B is administered (up to 5 or 6 mg/kg) (17,25). Encouraging efficacy results are also available on a more anecdotal basis (17,30,33). Larger clinical trials evaluating the potential clinical benefit of these new modalities should be performed; however, such comparative studies should be done with commercially available preparations instead of “artisanal” preparations.

In addition, new developments in antifungal management should result from large clinical trials testing the adjuvant role and indications of various cytokines including G-CSF, GM-CSF, and/or M-CSF in severely immunocompromised patients with documented invasive fungal infections. Very limited data are available on this topic but several studies will be initiated in the near future to assess the potential benefit of such therapeutic modalities in patients with invasive fungal infections.

# Conclusions

Empiric antifungal treatment remains mandatory due to the difficulties in establishing an early diagnosis and due to the poor prognosis of invasive fungal infections. Numerous questions are still unanswered concerning the most appropriate drugs for empiric treatment and the specific role of the newer agents and administration alternatives for amphotericin B. The optimal timing for initiation of empiric antifungal therapy and which patients (other than granulocytopenic cancer patients) will benefit from such therapy also needs to be investigated.

Since optimal control of documented fungal infections presents a major challenge, effective prophylactic means are mandatory. While this issue has been extensively investigated for granulocytopenic patients, other patient groups should also be considered. Most studies using commercially available agents have shown decreased yeast colonization with prophylactic treatment, but the clinical impact of such therapy on the rate of invasive infection is still unclear.

Effective chemoprophylaxis to prevent aspergillosis is still lacking, but preliminary data with the new triazoles, such as itraconazole, are encouraging. Similarly, studies evaluating the potential role of fluconazole for chemoprophylaxis in granulocytopenic patients have shown a significant benefit, even in patients undergoing bone marrow transplantation (12). Optimal doses of fluconazole (100 to 400 mg daily), however, remain to be defined for those specific indications and a consensus is not yet available. Furthermore, the emergence of *C. krusei* in patients treated with fluconazole is a matter of concern (18,26,41).

Finally, issues such as a cost evaluation of invasive fungal infections will be mandatory. Taking into account the high cost of aggressive treatments for severe underlying diseases and the expense of newer therapeutic modalities (including liposomal preparations and cytokines), carefully designed and well planned clinical trials are necessary. However, the high mortality rate related to invasive fungal infections and the human catastrophe faced by these patients, their families, the medical staff, and the community should remain our primary objective.

Presently, there is an increased interest from the medical community, as well as from pharmaceutical companies, in the field of invasive fungal infections. This interest should only grow during this decade and will hopefully lead to better management of patients with invasive fungal infections.

Recently, the European Organization for Research and Treatment of Cancer (EORTC) Board approved the creation of a new cooperative group named EORTC Invasive Fungal Infections Cooperative Group. Its aim is to conduct, develop, coordinate, and stimulate clinical studies for the diagnosis, prevention, and treatment of invasive fungal infections in cancer patients. Epidemiological studies, along with cost evaluation studies, will also be encouraged. This comprehensive approach to various aspects of invasive fungal infections should lead to further improvement of the prognosis of immunocompromised patients.

# References

1. Aisner J, Schimpff SC, Bennett JE, et al. Aspergillus infection in cancer patients. Association with fire proofing material in a new hospital. *J Am Med Assoc* 1976;235:411-412.
2. Anaissie E. Opportunistic mycoses in the immunocompromised host: Experience at a cancer center and review. *Clin Infect Dis* 1992;14(Suppl 1):S43-S53.
3. Anaissie E, Bodey G, Kantarjian H, et al. Fluconazole therapy for chronic disseminated candidiasis in patients with leukemia and prior amphotericin B therapy. *Am J Med* 1991;91:142-150.
4. Arnow PM, Anderson RL, Mainous PD, et al. Pulmonary aspergillosis during hospital renovation. *Am Rev Respirat Dis* 1978;118:49-53.
5. Burch PA, Karp JE, Merz WG, et al. Favorable outcome of aspergillosis in patients with acute leukemia. *J Clin Oncol* 1987;5:1985-1993.
6. Cohen J. Clinical manifestations and management of aspergillosis in the compromised patient. In: Warnock DW and Richardson MD, eds. *Fungal Infection in the Compromised Patient*, 2nd ed. Chichester, England: John Wiley & Sons; 1991;117-152.
7. Denning DW, Tucker RM, Hanson LH, Stevens DA. Treatment of invasive aspergillosis with itraconazole. *Am J Med* 1989;86:791-800.
8. de Repentigny. Serodiagnosis of candidiasis, aspergillosis, and cryptococcosis. *Clin Infect Dis* 1992;14(Suppl 1):S11-S22.
9. Edwards JE, Filler SG. Current strategies for treating invasive candidiasis: Emphasis on infections in nonneutropenic patients. *Clin Infect Dis* 1992;14(Suppl 1):S106-S113.
10. EORTC International Antimicrobial Therapy Cooperative Group. Empirical antifungal therapy in febrile granulocytopenic patients. *Am J Med* 1989;86:668-672.
11. Gerson SL, Talbot GH, Lusk E, et al. Invasive pulmonary aspergillosis in adult acute leukemia: Clinical clues to its diagnosis. *J Clin Oncol* 1985;3:1109-1116.
12. Goodman JL, Winston DJ, Greenfield RA, et al. A controlled trial of fluconazole to prevent fungal infections in patients undergoing bone marrow transplantation. *N Engl J Med* 1992; 326(1):845-851.
13. Horn R, Wong B, Kiehn TE, Armstrong D. Fungemia in a cancer hospital: Changing frequency, earlier onset, and results of therapy. *Rev Infect Dis* 1985;6:646-655.
14. Karp JE, Burch PA, Merz WG. An approach to intensive antileukemia therapy in patients with previous invasive aspergillosis. *Am J Med* 1988;85:203-209.
15. Komshian SV, Uwaydah AK, Sobel JD, Crane LR. Fungemia caused by *Candida* species and *Torulopsis glabrata* in the hospitalized patient: Frequency, characteristics, and evaluation of factors influencing outcome. *Rev Infect Dis* 1989;2:379-390.
16. Lopez-Berestein G. Liposomes as carriers of antimicrobial agents. *Antimicrob Agents Chemother* 1987;31:675-678.
17. Lopez-Berestein G, Bodey GP, Frankel LS, et al. Treatment of hepatosplenic fungal infections with liposomal amphotericin B. *J Clin Oncol* 1987;5:310-317.
18. McQuillen DP, Zingman BS, Meunier F, Levitz SM. Invasive infections due to *Candida krusei*: Report of ten cases of fungemia including three cases of endophthalmitis. *Clin Infect Dis* 1992;14:472-478.



19. Merz WG. *Candida lusitanae*; frequency of recovery, colonization, infection and amphotericin B resistant. J Clin Microbiol 1984;20:1194-1195.
20. Meunier-Charpentier F, Kiehn T, Armstrong D. Fungemia in the immunocompromised host: Changing patterns, antigenemia, high mortality. Am J Med 1981;1:363-370.
21. Meunier F. Infections in patients with acute leukemia and lymphoma. In: Mandell GL, Douglas RG, Bennett JE, eds. *Principles and Practice of Infectious Diseases*, 3rd ed. New York: Churchill Livingstone; 1989; 2265-2275.
22. Meunier F. Candidiasis. Eur J Clin Microbiol & Infect Dis 1989;8:438-447.
23. Meunier F. New methods for delivery of antifungal agents. Rev Infect Dis 1989;11:S1605-1612.
24. Meunier F. Fluconazole treatment of fungal infections in the immunocompromised host. Seminars in Oncology 1990;17(3):19-23.
25. Meunier F, Prentice HG, Ringden O. Liposomal amphotericin B: Safety data from a phase II/III clinical trial with Ambisome. J Antimicrob Chemother 1991;28(Suppl B):83-91.
26. Meunier F, Aoun M, Bitar N. Candidemia in immunocompromised patients. Clin Infect Dis 1992;14(Suppl 1):S120-125.
27. Opal SM, Asp AA, Cannady PB, et al. Efficacy of infection control measures during a nosocomial outbreak of disseminated aspergillosis associated with hospital construction. J Infect Dis 1986;153:634-637.
28. Pfaller MA. Epidemiological typing for mycoses. Clin Infect Dis 1992;14(Suppl 1): S4-S10.
29. Powderly WG, Kobayashi GS, Herzig GP, et al. Amphotericin B resistant yeast infection in severely immunocompromised patients. Am J Med 1988;84:826-832.
30. Ringden O, Meunier F, Tollemar J, et al. Efficacy of amphotericin B encapsulated in liposomes (AmBisone) in the treatment of invasive fungal infections in immunocompromised patients. J Antimicrob Chemother 1991;28(Suppl B):73-82.
31. Sarubbi FA Jr, Kopf HB, Wilson MB, et al. Increased recovery of *Aspergillus flavus* from respiratory specimens during hospital construction. Am Rev Respirat Dis 1982;125:33-38.
32. Soulier JP, Coune A, Meunier F, et al. Pilot study of amphotericin B entrapped into sonicated liposomes in cancer patients with fungal infections. Eur J Cancer Oncol 1988;24:527-538.
33. Soulier JP, Bron D, Coune A, Meunier F. Successful treatment with liposomal Amphotericin B in two patients with persisting fungemia. Eur J Clin Microbiol Infect Dis 1989;8:903-907.
34. Sheretz RJ, Belani A, Kramer BS, et al. Impact of air filtration of nosocomial *Aspergillus* infections: Unique risk of bone marrow transplant recipients. Am J Med 1987;83:709-718.
35. Van't Wout JW, van Furth R. A prospective study of the efficacy of fluconazole (UK-49,858) against deep-seated fungal infections. J Antimicrob Chemother 1988; 21:665-672.
36. Walsh TJ, Pizzo PA. Nosocomial fungal infections. Ann Rev Microbiol 1988;42:517-547.
37. Walsh TJ, Pizzo PA. Fungal infections in granulocytopenic patients: Current approaches to classification, diagnosis, and treatment. In: Holmberg K, Meyer R, eds. *Diagnosis and Therapy of Systemic Fungal Infections*. New York: Raven Press Ltd.; 1989; 1-24.
38. Weber DJ, Rutala WA. Epidemiology of hospital-acquired fungal infections. In: Holmberg K, Meyer R, eds. *Diagnosis and Therapy of Systemic Fungal Infections*. New York: Raven Press Ltd.; 1989; 1-24.

39. Wey SB, Mori M, Pfaller MA, Woolson RF, Wenzel RP. Hospital-acquired candidemia. The attributable mortality and excess length of stay. *Arch Intern Med* 1988;148:2642-2645.
40. Wingard J, Merz W, Saral R. *Candida tropicalis*: A major pathogen in immunocompromised patients. *Ann Intern Med* 1979;91:539-543.
41. Wingard JR, Merz WG, Rinaldi MG, Johnson TR, Karp KE, Saral R. Increase in *Candida krusei* infection among patients with bone marrow transplantation and neutropenia treated prophylactically with fluconazole. *N Engl J Med* 1991;325(18):1274-1277.



# **Nosocomial Infection Trends in Europe**

Donato Greco, M.D. and M.L. Moro, M.D.

*Istituto Superiore di Sanità, Italy*

# Introduction

## *Estimating the Size of the Problem*

Each year, approximately 10% of Western Europe's half a billion inhabitants are admitted to the hospital and about 5% of these patients acquire some type of hospital infection. This represents an estimated total of more than 25,000,000 hospital-acquired infections (HAI) per year. If Eastern Europe is included, this estimate potentially doubles, reaching an annual incidence of 50,000,000.

Several attempts have been made to calculate a monetary value for HAIs in Western Europe. The cost of just the additional length of hospitalization resulting from an HAI has been estimated to be nearly 1,000 ECUs per patient (4,5). This translates into 25 *billion* ECUs each year for Western Europe, a sum equal to the total health expenditure of several countries.

## *Is There an Increase or Decrease in the Incidence of Hospital-Acquired Infections?*

An analysis of trends requires that we first determine the following:

- a) What are we measuring;
- b) Which tools to use;
- c) What the background level is;
- d) What should be used as a chronological starting point;
- e) Why we are analyzing trends; and
- f) What are we going to do with the analysis.

# What Are We Measuring

The association between hospitalization and infection has been recognized since the beginning of modern medicine. Only in the last century, however, has this association been confirmed with a case definition provided by microbiological and epidemiological research (18). The microbiological definition of infection is limited in its contribution to infection control measures. For many years, hospital microbiologists devoted a vast amount of time to studying HAIs, yet only in the late 1970s did the standardized case definition — which includes clinical symptoms — demonstrate to clinicians the gravity of the situation.

Many of the advances in infection control are a result of the case definition protocol created by the Centers for Disease Control in Atlanta, GA (U.S.). This protocol allowed researchers working in this field to apply the definition on a large scale, even in the absence of highly qualified microbiological laboratories. Hospital-acquired infections, defined as clinical infections developing during or after hospitalization that were neither present nor in incubation at admission, was an easily applicable definition in most hospital settings.

# Which Tools Should be Used

## *HAI Prevalence*

A one-day survey in hospital wards discriminating between infected or non-infected patients according to a case definition protocol has been the simplest and most frequently applied tool in HAI measurement. In the early 1970s, national prevalence surveys were conducted both in the United Kingdom and the United States (10,12). The results of these surveys were alarming: between 5% and 10% of all hospitalized patients were found to be suffering from a hospital-acquired infection on any given day. The technique used in these prevalence surveys was relatively simple and several countries were able to perform similar investigations at the national level. Table I shows the results of several national prevalence surveys in European countries (11).

**Table I. Prevalence of Hospital-Acquired Infections in Italy and in Five Other Multinational Studies**

Country	Year	No. of Patients	No. of Hospitals	Prevalence Patient	Prevalence Infections/100
Italy	1983	34,577	130	6.8	7.6
Tuscany	1987	5,564	26	5.1	6.4
Various	1987	28,861	42	8.7	9.8
Great Britain	1980	18,163	43	9.2	*
Denmark	1987-89	2,920	25	*	11.3
Norway	1979	7,833	15	9.0	*
Belgium	1984	8,723	106	9.3	10.3

The World Health Organization (WHO) has adopted the same technique to perform a coordinated national survey in many developing countries. A sampling of the results obtained from this large international effort are presented in Table II; in this Table, infection prevalence data are organized by medical specialty (12). It is readily apparent that there is considerable variation in the prevalence of hospital-acquired infections among different medical specialties. This wide range of prevalences was probably due to differences in the specialty definitions, and therefore, in the types of treatment and in the case-mix of patients treated. The observed variability can also be explained, in part, by the small number of patients studied by each specialty in each hospital.

## *Limitations of Prevalence Surveys*

Prevalence surveys are a very powerful tool; single-day surveys, which consume only limited resources, are capable of translating knowledge about HAIs into easily comprehensible data. These data can subsequently be used to launch national programs aimed at controlling HAIs.

Prevalence surveys have also been shown to be effective in convincing politicians to take action against HAIs.

Prevalence surveys have often been repeated in the same hospital over a period of time. Although data from these surveys are valuable for tracking the occurrence of HAIs across time, in most cases, this approach cannot be used to obtain information on risk factors and incidence-associated procedures which are essential for control initiatives.

In summarizing the limitations of prevalence surveys, the following points should be stressed:

- a) they tend to overestimate the HAI situation because long staying infected patients are represented more frequently;
- b) they provide limited information on risk factors and their association to hospital-acquired infections;
- c) they are limited with respect to the quality of case definition;
- d) they provide little information on the ward procedures that are potentially associated with HAIs;
- e) they often consist of an external intervention lasting a single day in the ward and hence have a very limited impact on the personnel in charge of infection control;
- f) it is difficult to estimate trends with prevalence surveys; and
- g) information from prevalence surveys are of little use for localized interventions.

### *Incidence Studies*

The limitations of prevalence surveys prompted many European countries to alternatively conduct multicenter incidence studies on HAIs beginning in the early 1980s, both as routine surveillance and as specially designed studies. Surgical wards were the most frequently targeted sites for these studies (3-15), but intensive care units and neonatal units were also frequently included.

In the 1980s, an ad hoc group of national experts, the European Working Party on Hospital Infections, coordinated numerous incidence studies in nine European countries. These studies were solely funded by the participating countries (13-17). The group successfully completed incidence studies on urinary catheter and urinary tract infections; septicemia and intravenous devices; and total body wash and wound infections. A number of years after these studies were conducted, the European Economic Community funded a European research program on HAI incidence in intensive care units (ICU). Results of this study confirmed the very high incidence of HAIs in ICUs.

**Table II. Prevalence of Hospital-Acquired Infections by Type of Medical Specialty**



Medical Specialty	Italy		Tuscany		WHO		U.K.	
	No. of Patients	Prevalence/100	No. of Patients	Prevalence/100	No. of Patients	Prevalence/100	No. of Patients	Prevalence/100
Internal Medicine	14,635	6.2	2309	5.7	8,144	8.0	4,788	7.6
Surgery*	8,767	7.6	1606	5.7	5,438	13.1	3,896	12.5
Obstetrics	1,636	4.4	—	—	3,012	5.8	2,405	4.4
Gynecology	761	5.1	393	3.8	2,009	6.7	1,037	11.0
Orthopedics	2,930	8.2	735	6.9	2,107	11.2	2,315	13.1
Geriatrics	805	11.6	—	—	—	—	1,537	10.1
Pediatrics	1,216	6.3	328	7.0	3,147	8.7	859	4.1
ENT	882	4.3	115	4.3	1,206	4.4	537	6.3
Ophthalmology	1,079	1.6	172	1.7	1,017	2.6	390	2.1
Intensive Care**	1,539	12.5	176	5.7	974	13.3	400	16.8

\* Includes general surgery, thoracic surgery and urology

\*\* Includes cardiovascular surgery, neurosurgery, and neonatal pathology

The WHO Regional Office for Europe has played a substantial role in the European activities on hospital-acquired infections. In addition, the WHO headquarters in Geneva has shown interest in HAI control, resulting in the establishment of the International Prevalence Survey. Efforts have also been made in Europe to encourage member countries to implement HAI control programs. Meetings, training courses, consensus documents, and field activities were begun in the 1980s, and remain in operation to date. One example of these efforts is the DANOP study, which consists of a standardized surveillance system for the incidence of wound infections and employs a user-friendly standardized software (8). Following the multicenter DANOP study, WHO developed a software package aimed at the surveillance of HAIs (the WHOCARE system).

# What the Background Level Is

Past experience in Europe and in many other countries has confirmed that the most effective means of starting a national program on HAI control is to conduct national prevalence surveys. However, experience has also shown that these studies have certain limitations with respect to the daily procedures involved in infection control. Consequently, a more complete and inclusive evaluation of the HAI situation is necessary. After having defined the magnitude of the problem and having obtained a description of its overall characteristics, active interventions must be performed. Additionally, different evaluation methods must be defined in order to determine the effectiveness of such initiatives.

In examining trends in HAI prevalence, it is necessary to take into account the range in prevalence among the different hospitals and hospital services included in this survey and among the prevalence confidence limits. To illustrate this point, let us take a hypothetical situation in which a one-day HAI prevalence survey was performed annually over a period of time, assuming that the population surveyed, case definition, and diagnostic procedures remained constant over time and that patient groups were comparable. Let us further assume that the prevalence of HAI across all cases is 6.8% and that the control program has been quite effective, with the HAI prevalence reduced by 50% over a period of 5 years at an annual reduction of 10%.

The impact of examining HAI prevalence at the national, regional, and local levels is presented in four cases described below.

**Case No. 1: National Level: 83 participating hospitals with a total of 30,000 patients surveyed annually**

The trend in HAI prevalence, with 99% confidence limits, is presented in Figure 1. The results were satisfactory; however, the prevalence of HAI varies widely across individual hospitals as a result of their service-mix and case-mix (Table II). If different hospitals are included in successive surveys, the national prevalence observed can vary widely and the observed trend cannot reflect the success of control programs (Figure 2).

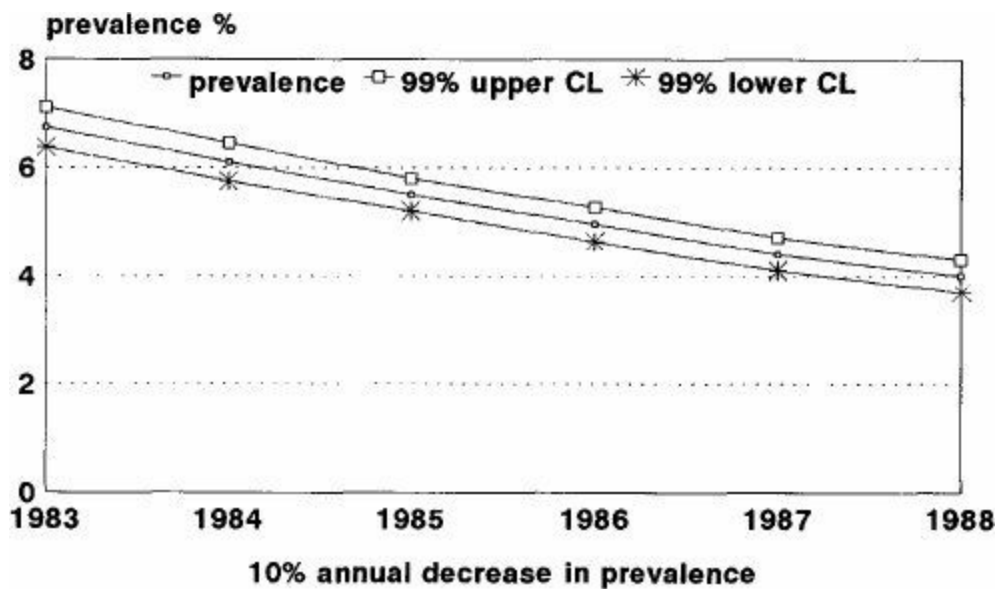

Figure 1. HAI Prevalence Trend in a Hypothetical Population at Country Level with 99% Confidence Limits

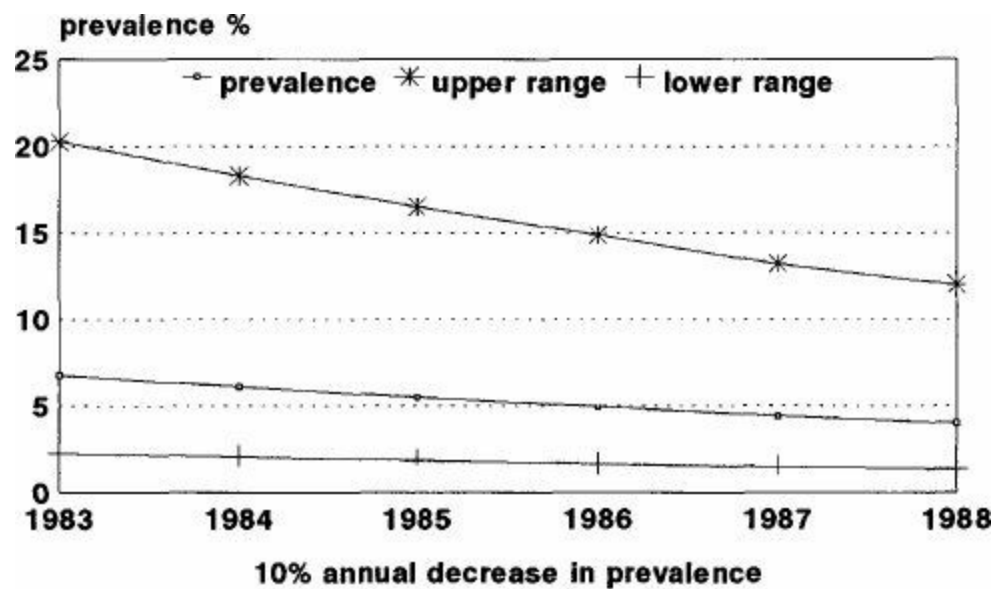

Figure 2. HAI Prevalence Trend In a Hypothetical Population, Taking Into Account the Variability Among Individual Hospitals

Case No. 2: Regional Level: Seven participating hospitals with 3,000 patients surveyed annually

If 3,000 patients are studied annually in regional surveys, there is a greater observed standard of error (Figure 3) and it is more difficult to compare each year with the following one. However, a decreasing tendency is apparent and may indicate the long term success of the control program. The same information, but with intervals around the prevalence ranges for the various hospitals, is shown in Figure 4. The range is narrower in this case ( $\pm 2$  times the regional prevalence) because only seven hospitals are involved. As on a national level, all hope

of showing a decrease in the HAI prevalence is lost when the data are examined in this manner.

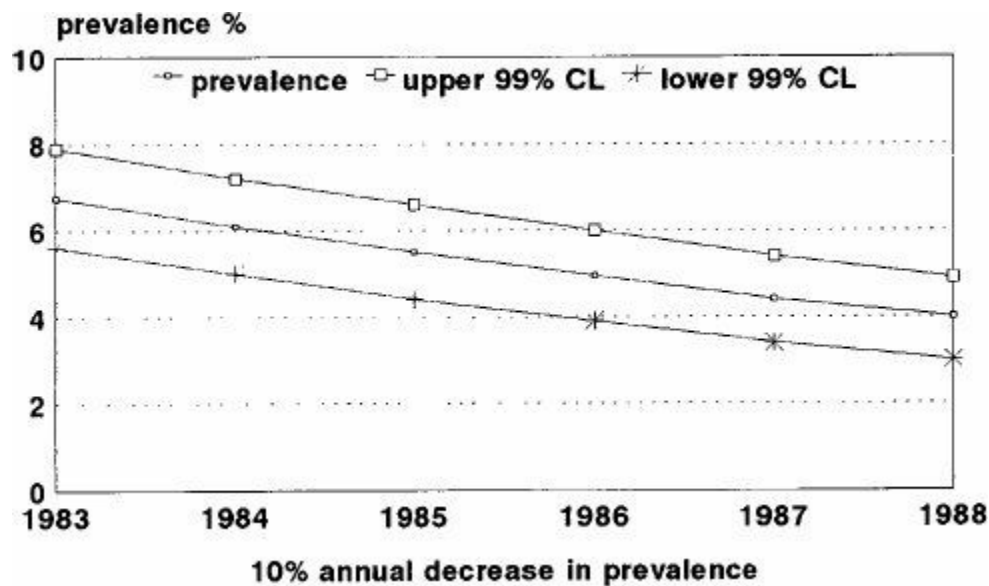

Figure 3. HAI Prevalence Trend in a Hypothetical Region with 99% Confidence Limits

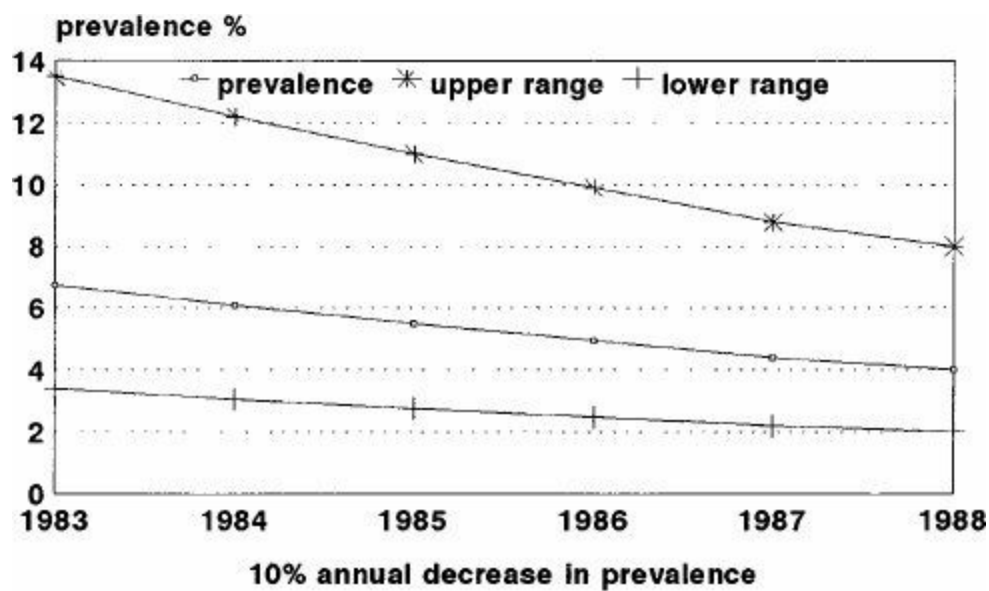

Figure 4. HAI Prevalence Trend in a Hypothetical Region with Prevalence Range

Case No. 3: Local Level: One participating hospital with 700 patients surveyed annually

Although there is no interhospital range in this example, there is still a range among hospital services. The sample is small so a trend is not apparent and the probability of a significant statistical difference between the trend's extreme points is very limited, especially if we want to analyze the data by ward or patient diagnostic groups where the sample would be even smaller (Figure 5).

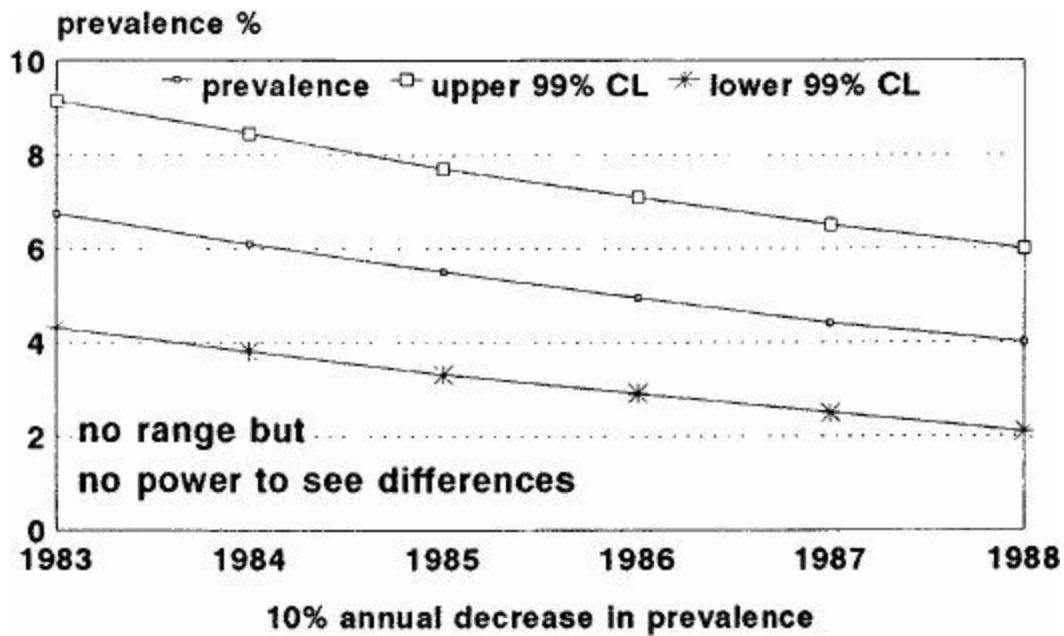

Figure 5. HAI Prevalence Trend in a Hypothetical Hospital With 99% Confidence Limits

Case No. 4: Local Level: One surgical hospital ward involved in continuous surveillance: each patient has a hospital stay of 10 days; an initial incidence of 12.5% with a 10% annual decrease in incidence.

Figure 6 shows the incidence trend for this hypothetical case with 99% confidence limits. The variance in incidence density is much smaller because of the patient/day denominator; many patients can be enrolled, however, because the surveillance is active for 365 days a year. Patient groups are more likely to be comparable over time and the trend shows distinct annual differences.

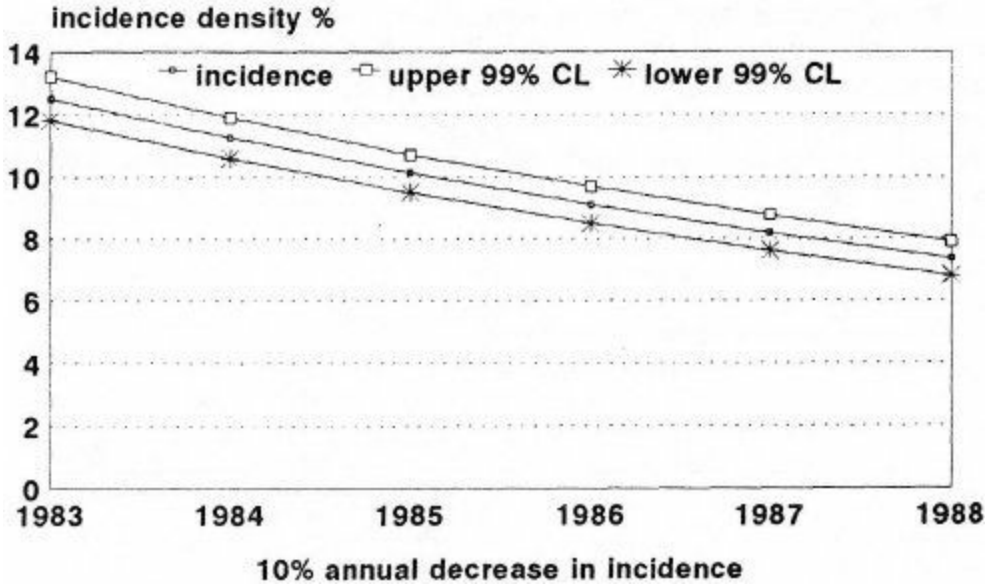

Figure 6. HAI Incidence Trend In a Hypothetical Surgical Ward with 99% Confidence Limits

Figure 7 shows results from the International WHO Prevalence survey (19); the prevalence of infections is plotted by individual hospital. Fifty percent of the hospitals had an infection prevalence in the range of 8-10%, while the other half were equally divided between lower and higher values. Table II from the same study previously showed the prevalence by type of medical specialty in which prevalence estimates ranged from 2.6 in ophthalmology to 13.3 in intensive care, and 13.1 in surgical units.

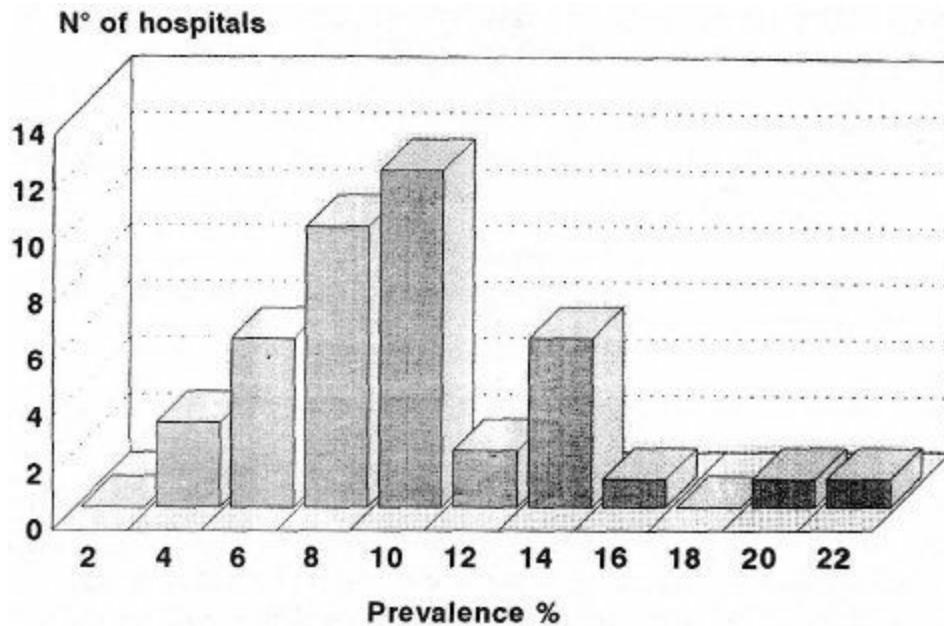

Figure 7. International Prevalence Survey on HAI. Prevalence by Hospital

The different risks of HAI associated with the various hospital specialties and services has been widely recognized and has been observed in all studies of hospital-acquired infections. Therefore, the specialty-mix of the study population determines the overall frequency of HAIs reported for any given study, as well as the mix of the patients treated (case-mix). The variability of infection prevalence in various hospitals in four prevalence surveys is shown in Table III.

**Table III. Variability in Infection Prevalence in Various Hospitals Included in Four Prevalence Studies**

	Prevalence/100	
	Average	Range
Italy	6.8	2-24
Tuscany	5.1	0-12
WHO	8.7	3-19
U.K.	9.2	2-18

Different methods have been proposed for classifying patients by their “intrinsic risk” of infection. Most methods are based on subjective evaluation of each patient by medical personnel, with great limitations of repeatability. To date, DRG classification, though widely used for describing the case-mix in hospitals, has not been applied to the study of HAIs. The

results of an Italian incidence study of wound infections (PRINOS), involving 3,547 patients from 18 general surgery wards, suggest that severity of disease should be taken into account when studying HAIs (9). Among the 350 patients with complications and comorbidities of the principal diagnosis (all HAIs recorded as complications were excluded for this comparison), the incidence of wound infections was 10.6%, more than twice the 4.2% incidence recorded among all the other 3,197 patients (Table IV).

**Table IV. PRINOS Project: Incidence of Wound Infection by Complication and Comorbidities**

	Patients with Complications	Patients without Complications
N	350	3,197
Incidence	10.6%	4.2%

These data show that comparisons among countries and even among hospitals can be misleading if the specialty-mix and the case-mix of the different populations are not taken into account. The same applies to individual hospitals when the overall frequency of infection is used to compare different periods of time as well as for the purpose of interpreting secular trends.

The above considerations are even more applicable to the planning of effective strategies for the control of hospital-acquired infections. HAIs clearly depend on the case-mix of patients. High rates of morbidity reported in the literature are directly related to illness severity, to units in which the severely ill are more concentrated, and to units where medical devices are part of routine procedures. Moreover, severely ill patients are more frequently exposed to special procedures compared to less severe patients. In order to plan an effective intervention, it is necessary to identify the patient-care practices amenable to modification by application of different care standards which have been shown to be effective in preventing hospital-acquired infections.

In conclusion, measuring only the prevalence of HAIs is not sufficient; we need to define risk factors which influence the probability of acquiring an HAI such as patient age, underlying disease, and type and length of invasive procedure. We have to adjust our indicator to patient severity and build Infection Risk Indices that render patient groups truly comparable or that allow for a more reliable comparison of the “before” and “after” intervention.

# What Should Be Used As a Chronological Starting Point

There is a great deal of evidence that infections were the primary cause of death for patients hospitalized in surgical and obstetrics wards in the past several centuries. In order to examine the recent history of hospital infections, we must begin with the late 1960s when the modern approach to hospital-acquired infections was born. The more recent the chronological starting point of our trend, the more accurately we can interpret information concerning the intervention in question.

In the last few years, many historical events have occurred that could have influenced comparisons with previous years. The AIDS epidemic is a particularly relevant event, in many countries fear of the contagion helped in implementing programs for HAI control; health care workers in HIV infection managed to take practices that were difficult to implement only several years earlier and turn them into common practices. Furthermore, the legal implications involved in the AIDS epidemic made hospitals aware of the need for creating a hospital infection control committee. The destruction of the Berlin Wall also had a great impact on the situation in Europe. Many Eastern European countries revealed their public health problems, showing to the world a desperate need for cooperation and resources.



# Why We are Analyzing Trends

There are basically two reasons for defining trends in hospital-acquired infections:

- a) to carry out interventions for infection control and to see if preventive measures have been effective; and
- b) to make a valuable contribution to scientific knowledge on the whole.

The U.S. SENIC study is by far the largest and most sophisticated attempt to evaluate the impact of HAI control programs at the national level (19). The information gathered is extremely useful because the results clearly indicate that control programs can be effective in decreasing HAI incidence. A European SENIC study would not be of use because European governments do not pay for hospital services, as does the U.S. government. Europe lacks the administrative and managerial services, such as hospital accreditation and insurance benefits, which allow infection control in the U.S. to be effective. It is therefore unlikely that very non-homogeneous trends would be useful on a very large scale, as would be the case for Europe. Furthermore, there is little hope that the EEC will take further initiatives to control the occurrence of HAIs.

On the other hand, many European countries are continuing to gather information from targeted surveillance systems and cooperative incidence studies. Several European studies on infection control efficacy programs have been published, in particular, those conducted in the United Kingdom (10), Sweden (14), and Belgium (16), the evaluation study on surgical infections conducted in Italy (9), and the studies on infection control carried out in Denmark (7). These studies have been extremely valuable in focusing on the objectives of HAI prevention and control within the wider frame of hospital services quality control.

# What Are We Going to Do With the Analysis?

Trends of HAI incidence are particularly important for professionals working on infection control because they need to know whether or not preventive measures have been effective. Consequently, analyzing trends is particularly effective at the local level, using incidence density indices that make trends possible. In the last several years, many countries in Europe have been implementing these procedures.

# Is There an Increase or Decrease in the Incidence of HAI Trends?

In Europe, prevalence surveys carried out in the 1980s can be used as the starting point for analyzing trends in hospital-acquired infections. However, the above considerations reveal that there is no end point for the trend line. Though it is difficult to define an overall trend for Europe, many studies conducted in specific countries or geographic areas have shown that there has been a decrease in HAIs as a direct result of control programs. Furthermore, in the last two decades, all Western European countries and some Eastern European countries have implemented national laws, recommendations, and/or guidelines aimed at controlling the HAI epidemic. Several factors influencing the decrease in HAI incidence are listed below, together with those factors that are likely to increase the incidence. The factors influencing the decrease in HAI incidence outweigh the negative factors. Let me conclude that the human factor was and is the major component of this good result.

## *Factors Influencing a Decrease in HAI Incidence*

1. Increasing economic strains which result in reduced length of hospital stay
2. Increased alternatives to hospitalization (i.e., day hospitals, home care, and improvement of outpatient diagnostic services)
3. Increase of noninvasive diagnostic procedures
4. Improvement of HAI surveillance
5. Increase in the number of infection control nurses
6. Disinfection/sterilization protocols
7. Reduction of unnecessary urinary catheters
8. Improvement of closed urinary catheters
9. Better use of antimicrobial prophylaxis
10. Improvement of infection control measures in surgery (e.g., reduction of preoperative shaving)

## *Factors Influencing an Increase in HAI Incidence*

1. Aging of the population
2. More chronically ill and severe cases
3. Increase of high risk individuals in hospitals (i.e., low birth weight infants, immunocompromised patients, and transplant patients)
4. HIV epidemic
5. Reduction of health resources

# References

1. Ayliffe GAJ. Infection control in the United Kingdom. *Chemotherapy* 1988;34:536-540.
2. Brachman PS, Eickhoff TC. Proceedings of the International Conference on Nosocomial Infections. American Hospital Association, Chicago. 1971.
3. Cruse PJE, Foord R. The epidemiology of wound infection: a ten-year prospective study of 62,939 wounds. *Surg Clin North Am* 1980;60:27-40.
4. Davey P, Hernanz C, Lynch W, Malek M, Byrne D. Human and non-financial costs of hospital-acquired infection. *J Hosp Infect* 1991;18(Suppl. A):79-84.
5. Drummond MF, Davies ML. Evaluation of the costs and benefits of reducing hospital infection. *J Hosp Infect* 1991;18(Suppl. A):85-93.
6. Haley RW, Culver DM, White JW, et al. The efficacy of infection surveillance and control programs in preventing nosocomial infections in US hospitals. *Am J Epidemiol* 1985;121:182-205.
7. Jepsen OB, Mortensen N. Prevalence of nosocomial infection and infection control in Denmark. *J Hosp Infect* 1980;1:237-244.
8. Kjaeldgaard P, Cordtz T, Sejberg D, et al. The DANOP-DATA system: a low-cost personal computer based program for monitoring of wound infections in surgical ward. *J Hosp Infect* 1989;13:273-279.
9. Greco D, Moro ML, Tozzi AE, De Giacomi GV and the Italian PRINOS Study Group. Effectiveness of an intervention program in reducing postoperative infections. *Am J Med* 1991;91(Suppl. 3B):164-169.
10. Meers P, Ayliffe G, Emmerson A, et al. Report on the national survey of infection in hospitals, 1980. *J Hosp Infect* 1981;2(Suppl.):1-51.
11. Moro ML, Giuliano G. Le infezioni ospedaliere in Italia. *Epidemiol Prev* 1991;48-49:33-37.
12. Moro ML. The WHO international prevalence surveys of nosocomial infection and antibiotic usage studies in Italy and their link with quality assurance programs. *Control de Calidad Asistencial* 1988;3(2-4):102-106.
13. Nystrom B, Olesen Larsen S, Dankert J, et al. Bacteraemia in surgical patients with intravenous devices: a European multicentre incidence study. *J Hosp Infect* 1983;4:338-349.
14. Nystrom B. Hospital infection control in Sweden. *Chemotherapy* 1988;34:541-547.
15. Olson M, O'Connor M, Schwartz ML. A 5-year prospective study of 20,193 wounds at the Minneapolis VA medical center. *Ann Surg* 1984;199(3):253-259.
16. Reybrouck G, Mertens R. Infection control and hospital hygiene in Belgium. *Infect Control Hosp Epidemiol* 1989;10(4):170-174.
17. Rotter ML, Olesen Larsen S, Mary Cooke E, et al. A comparison of the effects of preoperative whole-body bathing with detergent alone and with detergent containing chlorhexidine gluconate on the frequency of wound infections after clean surgery. *J Hosp Infect* 1988;11:310-320.
18. Selwyn S. Hospital infection: the first 2500 years. *J Hosp Infect* 1991;18(Suppl. A):5-64.
19. World Health Organization. Report of an International Survey on the prevalence of hospital-acquired infections. Meeting on Hospital Infection Prevalence Surveys. Geneva, 20-22 October 1986.



# **Nosocomial Outbreaks of International Significance**

**William R. Jarvis, M.D.**

*Centers for Disease Control and Prevention, U.S.A.*

# Introduction

Nosocomial infections are an important cause of morbidity and mortality throughout the world. Although nosocomial outbreaks account for only a minority of nosocomial infections, these outbreaks are an important source of epidemiologic knowledge (9). The information learned through combined epidemiologic and laboratory investigations of outbreaks is of potential benefit to infection control personnel throughout the world. This paper describes the epidemic investigation experience of the Hospital Infections Program (HIP) at the Centers for Disease Control and Prevention (CDC) from January 1990 through April 1993. This overview will provide insight into recent epidemic investigations and describe important findings from these investigations that may be of value to the infection control community. In addition, three nosocomial outbreaks that have international implications will be described.

# Background

CDC has a training program called the Epidemic Intelligence Service (EIS) in which physicians, nurses, veterinarians, and other personnel spend 2 years in training in epidemiologic methods at CDC. These EIS Officers are continuously “on call” to investigate outbreaks in the U.S. or throughout the world. In order for a nosocomial outbreak investigation to be initiated, the hospital’s infection control and administrative personnel and the state health department or the ministry of health must invite CDC to initiate an investigation. Except in unusual circumstances, the cost of this investigation is borne by CDC.

The criteria used to select outbreaks for investigation include potential public health impact (i.e., morbidity and mortality), the likelihood that an investigation will advance our knowledge of nosocomial infection control and/or public health preventive interventions, and the likelihood that the investigation would be of educational benefit to the EIS Officer.



# Results

From January 1990 through April 1993, the HIP investigated 46 outbreaks in health care facilities. Of these, 16 (35%) were caused by bacteria; 12 (26%) were caused by mycobacteria; 6 (13%) each by fungi or noninfectious agents or materials; and 3 (6.5%) each by viruses or endotoxin/pyrogenic reactions. There were wide variations from year to year in the predominant pathogens causing these outbreaks: in 1990, bacteria accounted for 60% and mycobacteria for 14%; in 1991, bacteria accounted for only 27% of the outbreaks, fungi accounted for 20%, and mycobacteria and viruses accounted for 13% each; in 1992, 67% of the outbreaks investigated were caused by mycobacteria, in particular *Mycobacterium tuberculosis*.

Of the 46 outbreaks, 11 (24%) were associated with use of a product; 10 (21%) with a procedure; and 7 (15%) with use of a device. Eighteen (40%) were not associated with a product, procedure, or device. The association with a product, procedure, or device varied by year.

The outbreaks occurred in a wide variety of health care facility locations, including operating rooms (14 [30%]), hospital wards (16 [35%]), free standing dialysis clinics (5 [11%]), long-term care facilities (2 [4%]), radiology or bronchoscopy suites (1 [2%] each), and other locations (2 [5%]).

# New Associations

These outbreaks identified a number of new associations, including *M. abscesses* pseudoinfection associated with inadequate endoscope washing machines and *Enterobacter hormaechei* transmission associated with environmental contamination in a neonatal intensive care unit (Table I). Through the intensive application of epidemiologic methods and laboratory molecular techniques, these outbreak investigations have identified new pathogens and new sources of transmission and have advanced our understanding of the epidemiology of nosocomial infections. A description follows of several of these outbreaks which demonstrate the value of a collaborative epidemiologic and laboratory investigation.

**Table I. Selected Outbreaks in Which New Pathogens, Sources, or Modes of Transmission of Nosocomial Infection Were Identified, Hospital Infections Program, Centers for Disease Control and Prevention, January 1990 — April 1993**

Outbreak	Source/Mode of Transmission
<i>Mycobacterium Abscesses</i> Pseudoinfection	Contaminated endoscope washer <sup>1</sup>
<i>Enterobacter hormaechei</i> bacteremia	Contaminated environment with person-to-person transmission
<i>Yersinia enterocolitica</i> sepsis	Contaminated packed red blood cells <sup>2</sup>
Anaphylactic reactions in pediatric surgical patients	Latex
<i>Mycobacterium tuberculosis</i> Infections	Patient-to-patient and patient-to-health care worker airborne transmission
<i>Candida parapsilosis</i> bloodstream infections	Contaminated glycerin solution <sup>1</sup>
<i>Malazessia pachydermitis</i> bloodstream infections	Patient colonization with person-to-person transmission
Infections and/or endotoxin reactions in surgical patients	Contaminated anesthetic agent <sup>1</sup>
Bacterial sepsis	Contaminated pooled platelets <sup>2</sup>

<sup>1</sup> Extrinsic Contamination

<sup>2</sup> Intrinsic Contamination

## *Red Blood Cell-Associated Yersinia enterocolitica Sepsis*

From March 1987 through April 1993, 12 episodes of *Y. enterocolitica* sepsis and/or endotoxin shock were investigated (2,3,6). In each episode, the recipient of packed red blood cells (PRBCs) developed fever, hypotension, renal and respiratory failure, or disseminated intravascular coagulation within 15 minutes to 1 hour following the onset of transfusion. In each episode, the recipient had received PRBCs that had been stored for 25 to 42 days (mean, 33 days). A variety of serotypes were involved, including 0:3 (n=5), 0:5,27 (n=4), 0:1,2,3 (n=2),

and 0:20 (n=1). In all 12 episodes, cultures of the blood bag were positive for *Y. enterocolitica*. In 11 of 12 recipients, blood cultures were positive for *Y. enterocolitica*; the one patient in whom the blood culture was negative was receiving antimicrobials at the time of receipt of the contaminated blood and at the time the blood culture was obtained. In all 11 episodes in which the organism was recovered from the patient's blood and the blood bag, the serotypes were identical. Endotoxin concentrations in the blood bags ranged from 6.0 to >53,800 nanogram per milliliter. Despite intensive supportive care, 7 of 12 recipients of the contaminated PRBCs died.

In each episode, an investigation was conducted to review the procedures used in processing the blood. In no instance could we identify any breaks in aseptic techniques during either blood collection, processing, or handling of the blood after donation. However, interviews of the donors and their families found that 6 of 12 donors reported a history of gastrointestinal symptoms from 4 weeks before to 1 day after blood donation. These data suggest that the donors had either a mild or asymptomatic *Y. enterocolitica* infection before or at the time of donation. Our data suggest that these donors had low-level bacteremia at the time of blood donation and as a result of prolonged cold storage of the PRBCs, the organisms proliferated and caused sepsis and/or endotoxin shock at the time of infusion.

Before 1987, only six episodes of *Y. enterocolitica* sepsis associated with PRBC transfusion were reported in the world literature; only one of these occurred in the U.S. The recent occurrence of 12 episodes over 6 years, together with data suggesting that the incidence of *Y. enterocolitica* infections is increasing in the U.S., raises concerns that additional episodes may occur. These episodes demonstrate that if transfusion-associated sepsis is suspected, both the recipient's blood and the blood remaining in the bag should be cultured. Any bacterial isolates from the recipient, blood bag, or administration tubing should be saved until an investigation is complete. Suspected or confirmed episodes of transfusion-associated *Y. enterocolitica* sepsis should be reported to state and federal officials so that an investigation can be conducted and these data can be used to provide a better estimate of the frequency of this complication.

### *Anaphylactic Reactions Associated with Latex in Pediatric Patients*

Anaphylactic reactions in surgical patients in the operating room are infrequently reported. The majority of such reactions are associated with medications. Since 1991, we have conducted two epidemic investigations of anaphylactic reactions in patients in preparation for or undergoing surgical procedures (4). The definition used for an anaphylactic reaction in a patient undergoing general anesthesia was hypotension (a  $\geq 30$  mmHg fall in systolic blood pressure from preinduction blood pressure) and at least one of the following: rash, angioedema, stridor, wheezing, or bronchospasm (increased airway pressure, with or without a fall in arterial oxygen saturation). In epidemiologic studies, risk factors associated with anaphylactic reactions included having spina bifida, a history of allergy or asthma, and having a large number of surgical procedures. Serologic studies conducted on a subset of patients with anaphylactic reactions identified latex as the inciting antigen. Subsequently, a nationwide survey identified 32 (50%) of 64 children's hospitals in the U.S. reporting anaphylactic reactions in pediatric patients; 29 (91%) of all such reactions were reported after 1990.

Subsequent studies have shown that obtaining a thorough history about reactions to latex or rubber products before the surgical procedure is an excellent method for identifying patients at risk for anaphylactic reactions (12). Furthermore, performing surgical procedures in a latex-free environment and/or premedicating patients appears to reduce the risk or severity of these reactions. Further studies are being conducted to identify additional risk factors for anaphylactic reactions due to latex, evaluating serologic tests for detecting latex allergy, and conducting surveys in patient and health care worker (HCW) populations to determine the prevalence of these reactions.

### *Nosocomial Transmission of Multidrug-Resistant M. tuberculosis*

From 1989 through 1992, CDC investigated eight outbreaks of nosocomial transmission of multidrug-resistant *M. tuberculosis* (MDR-TB) (1,5,7,8,10,13). Before 1990, reports of nosocomial transmission of *M. tuberculosis* were infrequently reported; the majority of such outbreaks were usually traced to transmission from a previously unidentified patient with infectious tuberculosis (TB). However, our outbreak investigations have demonstrated a change in the epidemiology of nosocomial TB in health care facilities in the U.S.: most have involved primary MDR-TB infection in immunocompromised patients. These outbreaks have occurred in three states (Florida, New Jersey, and New York) and each outbreak has involved between 13 and 70 patients. All the infecting *M. tuberculosis* strains have been resistant to at least isoniazid and rifampin, except for one outbreak in which the infecting strain was resistant to isoniazid and streptomycin, but not rifampin. In many of these outbreaks, the infecting strain was also resistant to additional antituberculous agents. The majority of infected patients have had human immunodeficiency virus (HIV) infection or the acquired immunodeficiency syndrome (AIDS). Mortality has exceeded 70%, and the interval from TB diagnosis to death has been short, ranging from 4 to 16 weeks (median, 8 weeks).

Epidemiologic investigations have identified a number of risk factors for nosocomial acquisition of MDR-TB, including having HIV or AIDS, the duration of AIDS, previous hospitalization, hospitalization or exposure on the same ward as another infectious MDR-TB patient, exposure to an MDR-TB patient who is acid-fast bacillus sputum-smear positive, proximity to another infectious MDR-TB patient, and/or a low CD-4 T-lymphocyte count.

Other factors contributing to nosocomial MDR-TB transmission included delayed identification of TB, delayed initiation of effective antituberculous therapy, delayed initiation of appropriate patient isolation, inadequate isolation facilities (i.e., rooms were not under negative pressure, had fewer than six exchanges per hour, and/or did not exhaust air directly to the outside), failure to keep infectious MDR-TB patients in their isolation rooms with the doors closed, discontinuation of patient isolation while the patient was still infectious, failure to conduct aerosol producing procedures in protective environments, and failure of HCWs to wear appropriate respiratory protection. A national survey has found similar problems at other U.S. hospitals and indicates that strengthening our nosocomial TB control programs is needed (14). In each of these outbreaks, HCWs were also at risk of infection with MDR-TB. In most of the outbreaks, HCWs on the outbreak ward were at greater risk of a tuberculin skin test (TST) conversion than were HCWs on control wards (i.e., wards where TB patients were never or

infrequently admitted). In several of the hospitals, adequate baseline HCW TST data were not available. In three of the hospitals where adequate TST baseline data were available, HCW TST conversions ranged from 24/108 (22%) to 13/39 (33%) to 6/12 (50%) (10). In the eight outbreak hospitals, at least 17 HCWs have developed active MDR-TB; eight of these HCWs were HIV-positive. At least six of the 17 have died.

Subsequently, on-site follow-up epidemiologic investigations have been conducted at four of the MDR-TB outbreak hospitals. In each of these hospitals, infection control personnel have attempted to implement the recommended CDC 1990 Tuberculosis Guidelines (1,11,15,16). At one of the hospitals where the CDC Guidelines have been most fully implemented, nosocomial MDR-TB transmission to both patients and HCWs has been terminated (1,16). At the other three where the CDC guidelines have been less fully implemented, MDR-TB transmission to both patients and HCWs has been either substantially reduced or terminated (11,15). In one of the investigations, data suggested that improved clinician education to suspect TB, improved rapid diagnosis, and rapid triage of patients to appropriate isolation substantially reduced the risk of patient-to-patient MDR-TB transmission (15). Thus, these data strongly suggest the efficacy of the 1990 CDC TB Guidelines and demonstrate the importance of fully implementing these Guidelines to prevent nosocomial MDR-TB transmission.

# Conclusion

Although infrequent, nosocomial outbreaks offer unique opportunities to advance our knowledge of the epidemiology of nosocomial infections by identifying new pathogens, new sources of infection, new modes of transmission, and to evaluate the efficacy of preventive interventions (9). The outbreaks investigated by HIP during the study period reflect a minority of outbreaks that occurred in health care facilities during this time. The criteria used for selecting outbreaks to be investigated by HIP bias our overall findings. Nevertheless, the data obtained from these investigations are useful to the infection control community and should be used to further strengthen infection control programs.

With advances in medical technology and the introduction of new products, procedures, and devices, hospital epidemiologists and other infection control personnel should be alert to potential adverse reactions or complications associated with the introduction of these new technologies. Furthermore, when transmission of previously unusual nosocomial pathogens, such as *M. tuberculosis*, occur, we should assess our infection control policies and practices and ensure that guidelines are adequately implemented. In addition, we should assess these interventions to ensure that they are efficacious.

Recognition of nosocomial outbreaks requires that hospital epidemiologists and other infection control personnel maintain active surveillance for nosocomial infections. Surveillance can identify outbreaks, identify the source and mode of transmission of pathogens causing endemic or epidemic nosocomial infections, and provide data/guidance in developing and initiating effective interventions. Through the continued efforts of hospital infection control personnel throughout the world working in collaboration with state, federal, and international agencies, we can achieve our objective of reducing the incidence of nosocomial infections to the lowest levels possible.

# References

1. Beck-Sague CM, Dooley SW, Hutton MD, et al. Outbreak of multidrug-resistant tuberculosis among persons with HIV infection in an urban hospital: Transmission to staff and patients and control measures. *JAMA* 1992;268:1280-1286.
2. Centers for Disease Control. *Yersinia enterocolitica* bacteremia and endotoxin shock associated with red blood cell transfusion-United States, 1987-1988. *MMWR* 1988;37:577-581.
3. Centers for Disease Control. Update: *Yersinia enterocolitica* bacteremia and endotoxin shock associated with red blood cell transfusion-United States, 1991. *MMWR* 1991;40:176-178.
4. Centers for Disease Control. Anaphylactic reactions during general anesthesia among pediatric patients-United States, January 1990-January 1991. *MMWR* 1991;40:437-443.
5. Centers for Disease Control. Nosocomial transmission of multidrug-resistant tuberculosis among HIV-infected persons-Florida and New York, 1988-1991. *MMWR* 1991;40:585-591.
6. Tipple MA, Bland LA, Murphy JJ, et al. Sepsis associated with transfusion of red cells contaminated with *Yersinia enterocolitica*. *Transfusion* 1990;30:207-213.
7. Coronado VG, Beck-Sague CM, Hutton MD, Jarvis WR. Nosocomial transmission of multidrug-resistant *Mycobacterium tuberculosis* among persons with human immunodeficiency virus infection. *J Infect Dis* (In Press).
8. Edlin BR, Tokars JI, Grieco MH, et al. An outbreak of multidrug-resistant tuberculosis among hospitalized patients with the acquired immunodeficiency syndrome: Epidemiologic studies and restriction fragment length polymorphism analysis. *New Engl J Med* 1992;326:1514-1522.
9. Jarvis WR and The Epidemiology Branch, Hospital Infections Program. Nosocomial outbreaks: The Centers for Disease Control's Hospital Infections Program experience, 1980-1990. *Am J Med* 1991;91:101S-106S.
10. Jarvis WR. Nosocomial transmission of multidrug-resistant *Mycobacterium tuberculosis*. *Res Microbiol* 1993;144:117-122.
11. Maloney S, Pearson M, Gordon M, Del Castillo R, Boyle J, Jarvis W. Evaluation of recommended infection control measures in preventing nosocomial transmission of multidrug-resistant tuberculosis. The Third Annual Meeting of Society of Hospital Epidemiologists for America, April 18-20, 1993, Chicago, IL.
12. Pearson ML, Cole JS, Jarvis WR. How common is latex allergy? A survey of children with myelodysplasias. *J Dev Med Child Neurol* (In Press)
13. Pearson ML, Jereb JA, Frieden TR, et al. Nosocomial transmission of multidrug-resistant *Mycobacterium tuberculosis*: A risk to hospitalized patients and health-care workers. *Annals of Intern Med* 1992;117:191-196.
14. Rudnick J, Kroc K, Mananagan L, Banerjee S, Pugliese G, Jarvis W. How prepared are U.S. hospitals to control nosocomial transmission of tuberculosis? The Third Annual Meeting of Society for Hospital Epidemiologists of America, April 18-20, 1993, Chicago, IL.
15. Stroud L, Tokars J, Grieco M, Gilligan M, Jarvis W. Interruption of nosocomial transmission of multidrug-resistant *Mycobacterium tuberculosis* (MDR-TB) among AIDS patients in a New

York City Hospital. The Third Annual Meeting of Society for Hospital Epidemiologists of America, April 18-20, 1993, Chicago, IL.

16. Wenger P, Beck-Sague C, Otten J, Breeden A, Orfas D, Jarvis W. Efficacy of control measures in preventing nosocomial transmission of multidrug-resistant *Mycobacterium tuberculosis* among patients and health care workers. The Third Annual Meeting for Society of Hospital Epidemiologists of America, April 18-20, 1993, Chicago, IL.





# Risk Factors for Surgical Wound Infections

Hervé Richet, M.D.

*Institut de Biologie des Hôpitaux de Nantes, France*

# Introduction

Diseases may be prevented only if their risk factors are identified and therefore assessment of potential risk factors is the most important step toward prevention. Knowledge of the presence or the absence of these risk factors in surgical patients should be used for infection control purposes by either avoidance of these factors or by identifying high risk patients in order to provide adequate prophylaxis or close surveillance. Assessment of potential risk factors is easily accomplished by epidemiologic studies such as case-control or cohort studies. Interpretation of the results of such studies, however, is often difficult for the following reasons: multiple variables associated with the disease, varied characteristics of study patients, and confounding factors. Once risk factors have been identified, strategies of prevention should be carried out; unfortunately results of epidemiologic studies are sometimes ignored by the medical community. Twenty years ago, Cruse (1) identified preoperative razor shaving one day before surgery as a risk factor for surgical wound infection (SWI). Nevertheless, surgical patients are still universally shaved the night before surgery. Antibiotic prophylaxis is also an ignored risk factor. Twenty years ago, patients undergoing total hip replacement received cloxacillin for 2 weeks regardless of which risk factors they presented; today most orthopaedic patients receive a single-dose prophylactic antibiotic independent of their infectious risk (2). To administer the same type of antibiotic prophylaxis to all surgical patients implies that the risk of developing an infection is the same for all patients.

This paper will examine how knowledge of risk factors for SWI may allow for modifications of infection control techniques.

# What is a Risk Factor?

Epidemiologists use different definitions of risk factor; for some, a risk factor is “a variable that is believed to be related to the probability of an individual’s developing the disease before the point of irreversibility”. For others, a risk factor is a “risk indicator”, a “determinant of disease”, or “any variable causally related to the occurrence of disease”. Even if the definition varies, a risk factor is a variable whose presence must precede the occurrence of the disease and must be statistically associated with its development. In addition, the observed association must not be entirely due to any source of error, including chance, sampling error, or the involvement of other extraneous risk factors. Because there is no consensus on the definition of “risk factor” and its meaning is too vague, epidemiologists prefer to use the expressions “exposure”, “effect modifier”, or “confounding factor”.

A “risk factor” identified in univariate analysis may be a true determinant of the disease but it can also be an effect modifier or worse, a confounding factor. An effect modifier is a variable that modifies the association between exposure and the disease under study. In the case of a confounding factor, an apparent association between an exposure and a disease may actually be due to another variable. There is only one true risk factor when considering SWI, the surgical procedure itself. What we defined as “risk factors” are instead effect modifiers and in most studies, several are involved. An important purpose of the analysis of epidemiologic data is to measure the real weight of each identified risk factor and to consider how all of the factors interact with each other by using a stratified or multivariate analysis.

According to the type of risk factor identified, different prevention strategies may be initiated. If the risk factor is modifiable or avoidable actions directed toward this factor should prevent the occurrence of disease. If the risk factor is not modifiable or avoidable (e.g., age, underlying diseases) identification of high risk patients before the surgical procedure permits initiation of interventions directed toward disease modification, i.e., antibiotic prophylaxis, early antibiotic therapy, or close surveillance.

# Risk Factors For SWI

During the last 20 years many risk factors for SWI have been identified in epidemiologic studies (3,4,5). These include age; underlying diseases such as diabetes, obesity, malnutrition; duration of preoperative stay; preoperative shaving; operative technique and length; wound class; intraoperative contamination; use of electrosurgical units; American Society of Anesthesiologist's (ASA) score; abdominal drains; and presence of remote infection. These data can be used to implement strategies of prevention. Actions should first be started on those risk factors which are modifiable or avoidable. Because several of the above risk factors are neither modifiable nor avoidable (age, underlying disease, length of operation, ASA score, wound class), another strategy of prevention based on identification of high risk patients should be carried out. It is possible to identify high risk patients by using the surgical patient risk index.

## *Surgical Patient Risk Index*

For years surgeons and infection control practitioners thought that wound classification (clean, clean-contaminated, contaminated, and dirty) based on the likelihood that the wound would be contaminated by microorganisms was an accurate predictor of postoperative infections. Some authors, including Haley, later showed that other factors also played an important role in the development of postoperative infections and they emphasized the importance of identifying surgical patients at high risk of SWI (6). Haley et al were the first to develop a simple risk index for SWI by analyzing 10 potential risk factors by multivariate analysis. Their final model included four risk factors: an operation involving the abdomen, an operation lasting longer than 2 hours, an operation classified as either contaminated or dirty, and a patient having three or more diagnoses at discharge (6). The SENIC index was obtained by counting the number of risk factors present for each patient. This index proved to be a better predictor of infection than the conventional wound class. More recently Culver et al at the Centers for Disease Control (CDC) developed a modified risk index, the NNIS SWI index, by replacing the number of diagnoses at discharge by the ASA score which has the advantage of being available at the time of surgery (7). The SWI rate for 84,691 surgical procedures was determined for each category of risk index (0, 1, 2, and 3) and was 1.5%, 2.9%, 6.8%, and 13%, respectively. The CDC recommends using this risk index for comparison of SWI rates among surgeons and institutions and across time. This risk index is very useful for surveillance of SWI but cannot be used to identify high risk patients prior to the surgical procedure because some of the data needed are available only when the procedure is finished (i.e., length of operation and wound class) and the data are not very specific. Therefore, we have tried to develop a risk index for SWI which is applicable to specific surgical procedures, namely vascular surgery, and can be used to identify high risk patients at the time of operation. We used the same method as that used for developing the NNIS risk index.

A prospective multicenter study was conducted whose purpose was twofold: 1) to identify risk factors for SWI, and 2) to compare two regimens of antimicrobial prophylaxis (short: 3 injections of IV cefamandole, long: 9 injections of IV cefamandole) (8). Of 561 vascular surgery patients enrolled in the study, 23 (4.1%) developed SWI. Multivariate analysis using logistic regression analysis identified surgery on lower extremities, delayed surgery, diabetes mellitus,

past history of vascular surgery, and short antimicrobial prophylaxis as independent risk factors for SWI. A risk index was developed using the independent risk factors for SWI identified by logistic regression analysis. Each of these risk factors was coded 1 if present and 0 if otherwise. The risk index was calculated for each patient using Epi Info Version 5 (EPO; CDC) by counting the number of risk factors present. The SWI rate among the 561 vascular surgery patients in each of the four categories of risk index was calculated. The data indicated that the greater the risk index, the higher the rate of SWI. The rate of SWI was 1% (2/203) when the score was 0, and was 2.8%, 5.7%, and 25.7% when the score was 1, 2, and  $\geq 3$ , respectively. In addition, when compared with patients with a score of 0, the risk of infection was 2.9 greater in patients with a score of 1, 6 times higher when the score was 2, and 35 times higher when the score was  $\geq 3$ .

# Use of Risk Index for Prevention of SWI

Most of the risk factors identified in our study (8) were not avoidable or modifiable. Therefore, we hypothesized that one way to prevent SWI was to modulate the antimicrobial prophylaxis according to either the presence or absence of a risk factor or to the risk index. We further postulated that the risk index could be used to evaluate the efficacy of antimicrobial prophylaxis.

In general, a typical comparison of antimicrobial prophylaxis regimens is accomplished by examining the rates of infections and the rates of other complications observed in each group of patients. In our prospective study, patients were given 3 or 9 injections of IV cefamandole. No differences were observed when we compared the vascular surgery patients who received a short course of antimicrobial prophylaxis to those vascular surgery patients who received a longer course. The rates of postoperative infections (SWI, lower respiratory tract infections, and urinary tract infections) were similar in both groups as were the rates of patients who received antimicrobial therapy, the rates of reoperation and prosthesis removal, and the mortality rates (Table I).

**Table I. Antimicrobial Prophylaxis: Short Versus Long Conventional Evaluation**

	Prophylaxis		P-Value
	Short (N = 279)	Long (n = 282)	
Surgical wound infections	5% (15)	3% (8)	0.2
Lower respiratory tract infections	4% (11)	4% (11)	1.0
Urinary tract infections	4.3% (12)	5.3% (15)	0.7
Antimicrobial therapy	15% (41)	13% (36)	0.6
Reoperation	10% (29)	11% (30)	0.9
Prosthesis removal	0.7% (2)	1.4% (4)	0.7
All deaths	3.9% (11)	2.1% (6)	0.3
Death by infection	0.7% (2)	0.7% (2)	1.0

However, when the observed SWI rates in both prophylaxis groups were compared after stratification by the index risk score, no differences were noted for a score of 0, 1, and 2. The risk of SWI was six times higher (95% confidence interval: 1.4-24.4,  $p = 0.006$ ) among vascular surgery patients who had a score  $\geq 3$  and received a short prophylaxis than for patients with the same risk index who received a long prophylaxis (Table II).

**Table II. Short Prophylaxis Versus Long Prophylaxis Infection Rates According to The Risk Index**

Index	Prophylaxis		P-Value
	Short	Long	
0	1.9% (2/103)	0% (0/100)	0.5

1	2.6% (3/116)	3% (3/101)	1.0
2	6.4% (3/47)	5% (3/59)	1.0
$\geq 3^1$	53.8% (7/13)	9% (2/22)	0.006

<sup>1</sup> Relative Risk: 5.9, 95% confidence interval 1.4-24.4

To assess the exact role of antimicrobial prophylaxis on the risk of SWI, we performed a univariate stratified analysis of risk factors according to the type of antimicrobial prophylaxis. The results of the stratified analysis showed that the presence of diabetes, delayed surgery, and past history of surgery were risk factors for SWI only in patients who received a short prophylaxis (Table III) (8).

**Table III. Assessment of Risk Factors for SWI Following Vascular Surgery: Stratified Analysis According to the Type of Antimicrobial Prophylaxis**

Risk Factor	SWI				Relative Risk	95% CI	P-value
	Present		Absent				
	%	No.	%	No.			
<b>Short Prophylaxis</b>							
Diabetes	40	5	5	274	8	3-28	0.02
Past history vascular surgery	16	56	3	223	6	2-16	0.0005
Delayed surgery	29	28	3	269	10	4-26	0.0009
<b>Long Prophylaxis</b>							
Diabetes	14	7	3	275	6	0.8-40	0.2
Past history vascular surgery	5	84	2	198	2	0.6-9	0.2
Delayed surgery	6	35	2	247	2	0.5-11	0.3



# Conclusion

A better understanding of the epidemiology of SWI should enable surgeons and infection control practitioners to compare rates between hospitals and surgeons and should aid in the development of infection control strategies. Our development of a more specific risk index score for vascular surgery patients will be beneficial in the identification of high risk patients in order to provide adequate antibiotic prophylaxis and dose surveillance.

# References

1. Cruse PJE, Foord R. A five year prospective study of 23,649 surgical wounds. *Arch Surg* 1973;107:206-210.
2. Ericson C, Lindgren L, Lindberg L. Cloxacillin in the prophylaxis of postoperative infections of the hip. *J Bone Joint Surg* 1973;55A:808-813.
3. Nichols RL. Surgical wound infections. *Am J Med* 1991;91(3B):54S-64S.
4. Mayhall G. *Postoperative Infections in Prevention and Control of Nosocomial Infections*. In: Wenzel RP, ed. Baltimore: Williams and Wilkins; 1993.
5. Garibaldi RA, Cushing D, Lerer T. Risk factors for postoperative infection. *Am J Med* 1991;91(3B):158S-163S.
6. Haley RW, Culver DH, Morgan WM. Identifying patients at high risk of surgical wound infection. A simple multivariate index of patient susceptibility and wound contamination. *Am J Epidemiol* 1985;121:206-215.
7. Culver OH, Horan TC, Gaynes RP, Martone WJ, et al. Surgical wound infection rates by wound class, operative procedure, and patient risk index. *Am J Med* 1991;91(3B):152S-157S.
8. Richet H, Chidiac C, Prat A, David M, Maccario M, Cormier P, Bernard E, Jarvis WR. Analysis of risk factors for surgical wound infections following vascular surgery. *Am J Med* 1991;91(3B):170S-172S.



# Hospital-Acquired Infections in Japan

Hiroyoshi Kobayashi, M.D.

*The University of Tokyo Hospital, Japan*

# Introduction

With the advances in medical treatments over the last several years come an increase in the number of hospital-acquired infections. These can be categorized into three types: (1) conventional infectious diseases; (2) infections caused by unusual pathogens in compromised patients; and (3) occupational infections caused by bloodborne viruses. Factors affecting hospital-acquired infections in compromised patients include antibiotic abuse, immunosuppressant therapy, use of intravascular catheters and invasive monitoring devices, surgical operations involving artificial organs or implants, and the progress of burn therapy and emergency medicine. The major clinical isolates found in Japanese hospitals include *Staphylococcus aureus*, coagulase-negative Staphylococci, *Enterococcus* spp, *Escherichia coli*, *Klebsiella pneumoniae*, *Pseudomonas aeruginosa*, and fungi. The main pathogens involved in terminal infections include methicillin resistant *S. aureus* (MRSA), *P. aeruginosa*, and fungi. Though isolation rates are low, the following pathogens are also resistant to therapy: *E. fecium*, *Acinetobacter calcoaceticus*, and *Xanthomonas maltophilia*.

# Methicillin-Resistant *Staphylococcus aureus*

Since 1985, there has been an upsurge in the number of hospital-acquired infections caused by MRSA at the University of Tokyo Hospital. Although originally these MRSA-related infections occurred only in Tokyo they have recently spread to the rest of Japan. Following surveillance of 43 national university hospitals in August and September of 1990, 65% of all *S. aureus* isolates were MRSA. In July of 1992 the Ministry of Health and Welfare surveyed the isolation rates of MRSA throughout Japan. Among all isolated pathogens, only 12% were MRSA isolates; however, more than 60% of the *S. aureus* isolates were MRSA.

Minimum inhibitory concentrations (MIC) of 1,094 MRSA strains which were isolated from inpatients during 1990 were investigated. An MRSA strain was defined as having an MIC of oxacillin not less than 4 µg. The results of this investigation indicated that there were two groups of MRSA (see Figure 1). One group showed low concentrations of MICs for most drugs while the other group showed high MIC concentrations. Fortunately, a resistant strain against vancomycin was not found. Mupirocin ointment is not commercially available in Japan and povidoneiodine is the only effective agent currently available against MRSA. Approximately one-quarter to one-third of all MRSA strains, however, cannot be eliminated with this treatment. Encouragingly, isolation rates of MRSA have significantly decreased since 1990 due to the intensive efforts of hospital personnel (see Figure 2).

Drug	MIC (µg/ml)												
	≤0.06	0.13	0.25	0.5	1	2	4	8	16	32	64	128	>128
MPIPC							16	20	36	61	132	295	534
DMPPC				1	1	3	20	24	46	65	100	134	700
FMOX				1	15	55	81	69	99	147	252	291	84
IPM		108	37	27	19	26	29	36	83	192	246	267	24
OFLX			1	213	96	87	17	26	266	171	146	38	33
GM		3	50	91	49	7	2	27	41	151	262	213	198
MINO	3	144	295	62	83	22	19	71	287	105	2	1	
VCM			1	30	891	169	3						

Figure 1. MIC of MRSA Isolated from Inpatients

Year	n	No. newly isolated / No. newly admitted (%)		No. newly isolated / Total patient days of the month (per 10,000)	
		$\bar{X}$	S	$\bar{X}$	S
1989	12	3.23 <sup>a</sup>	0.70	12.63 <sup>d</sup>	2.85
1990	12	2.64 <sup>b</sup>	0.61	9.64 <sup>e</sup>	2.04
1991	12	1.87 <sup>c</sup>	0.69	7.45 <sup>f</sup>	2.79
1992*	11	1.60 <sup>g</sup>	0.48	6.42 <sup>g</sup>	2.06

<sup>b</sup> - <sup>g</sup>: p < 0.01      <sup>a</sup> - <sup>b</sup>, <sup>d</sup> - <sup>e</sup>, <sup>e</sup> - <sup>f</sup>: p < 0.05 (t-test)

<sup>g</sup>: not tested      \*: Apr. - Feb.

Figure 2. Prevalence of MRSA at the University of Tokyo Hospital

# Occupational Infections

Hepatitis B and C are currently the main occupational infections in Japan. Until recently, occupational infection of AIDS and Creutzfeldt-Jacob disease had not been seen in Japan, and adult T cell leukemia is a problem only for younger Japanese females as a source of perinatal infection because an adult does not acquire leukemia although he/she is infected and seroconverted.

The main route of bloodborne virus infections is by percutaneous contamination. Between December 1991 and May 1993, there have been 122 cases of percutaneous blood contaminations among hospital personnel at the University of Tokyo Hospital. Of these, 78% were needle stick injuries of which 64% (61 cases) occurred in doctors, 31% (29 cases) in nurses, and 5% (5 cases) in other medical personnel (Figure 3). Fifteen cases (12%) were contaminated with surgical suture needles, 4 (3.3%) with scalpels, and 8 (6.6%) with sharps in the waste. Among the contamination sources in these 122 cases, there were 8(6.6%) HBe antigen-positive cases, while antibodies to the hepatitis C virus were positive at a rate of 42.6%. However, there were no cases of seroconversion among those personnel contaminated with anti-HCV positive blood. Seventy-five of the 122 cases were already vaccinated with HBV, but only 22 cases (29%) had the effective doses of the antibody. We are currently using a longer lasting vaccination with recombinant hepatitis B vaccine from ovarian cells of Chinese hamsters.

Contamination	Dr.	Nr.	Others	Total
Needle	61	29	5	95 (78%)
Suture needle	10	4	1	15 (12%)
Scalpel	2	2	0	4 ( 3%)
Waste	1	3	4	8 ( 7%)
Total	74	38	10	122(100%)

Dec. 91 - May 93 6.8 cases/month

Figure 3. Percutaneous Contamination Rates Among Hospital Personnel at the University of Tokyo Hospital



# Conclusions

Systematized precaution is required for effective prevention of hospital infections. An infection control manual or guidelines are very important for the prevention of hospital infections. Recently, education programs for infection control nurses have been initiated in Japan. At the University of Tokyo Hospital, there is an Infection Control Service and an Infection Control Committee. The working parties consist of infection control physicians, clinical microbiologists, nurses, microbiological technicians, and pharmacists. All play an important role in the practice, surveillance, administration, monitoring, and research of hospital-acquired infections. In order to practice effective control measures, however, comprehension and cooperation among all hospital personnel is necessary.



# DISCUSSION

## Infection Control

## **Question for Dr. Rutala, University of North Carolina Hospitals, U.S.A.:**

In the U.S., is the definition of waste disposal going to be changed to one that is scientifically-based? What do you suggest?

## **Answer by Dr. Rutala:**

There is an effort in several states in the U.S. to reduce the number of types of medical waste that are treated as regulated medical waste. So far, however, there is no federal legislation, although a number of groups, including the American Medical Association and the American Hospital Association are espousing the use of epidemiologic and microbiologic data to develop the most sound definition of medical waste.

## Question for Dr. Rutala:

Please reexplain why some states have ruled out incineration of medical or infectious waste as an acceptable decontamination procedure.

## **Answer by Dr. Rutala:**

Essentially, incineration has not been ruled out as an acceptable decontamination procedure. In some states in the U.S., however, hospital incinerators can no longer be used because of emission restrictions. These chemical emission restrictions are based upon the best available technology and unless the hospital has the best available technology, the incinerators cannot be used.

## **Question for Dr. Jarvis, Centers for Disease Control, U.S.A.:**

Do you have evidence concerning nosocomial infections which resulted from a sterility failure in medical products?



## **Answer by Dr. Jarvis:**

No, I do not. The purpose of my presentation was to point out that the sterility assurance levels that are in existence today are in fact more than adequate and we do not have a problem with contamination of medical devices causing nosocomial infections. Rather, we have inadequate handling of devices and products by medical personnel before the products are inserted. Extrinsic, rather than intrinsic, contamination is the problem and education of health care workers is needed. I wanted to provide those examples because I think it is necessary to take the epidemiologic data that we have from outbreak investigations and surveillance and put it together with the data from industry to provide guidance on what are the appropriate sterility assurance levels to be used in the future.

## Question for Dr. Jarvis:

In one of the anaphylactic reaction outbreak hospitals in your presentation — Hospital B — 4 out of 10 pediatric patients had a sensitization to ethylene oxide residuals. Could you further characterize the magnitude of such sensitization? If latex residuals were removed from these patients would the ethylene oxide reactions be of an anaphylactic level?

## **Answer by Dr. Jarvis:**

Since we have not performed large scale population studies of the pediatric populations, I cannot comment on the prevalence of such reactions. I can say, however, that in the patients at this hospital, a latex sensitivity was still apparent when the ethylene oxide antibodies were absorbed out. Based on the epidemiologic data, we feel that the latex sensitivity was much more important. It is important to remember that in these populations, patients have multiple surgical procedures and therefore the likelihood that they will come in contact with medical devices that have been sterilized with ethylene oxide is very great. In subsequent studies, however, we have not found a link with ethylene oxide but we have found data supporting latex as the sensitizing agent both in national studies and in other outbreak investigations.

## **Question for Dr. Jarvis:**

Could you comment on the efficacy of the coated latex products developed for hypoallergenic use. Are they adequate to prevent anaphylactic reactions of the type described?

## Answer by Dr. Jarvis:

I cannot really comment on the elimination of anaphylactic reactions if coated latex products developed for hypoallergenic use are used instead since we have not performed such a study. We have found, however, that in the centers where pediatric patients had anaphylactic reactions, if a good history of latex reactions was obtained — i.e., does the patient have angioedema when he/she blows up a balloon; has he/she had other reactions to other rubber products — this information, along with the history of allergy or asthma, are very useful in identifying patients at risk if you then provide a “latex-free” environment. Those of you in manufacturing know that this is very, very difficult. If you go into an operating room environment it is almost impossible to identify which products have latex in them and which ones do not. The U.S. FDA is seriously considering requiring manufacturers to identify those products which contain latex to try and help with the situation. If this is done, these reactions can either be eliminated or, at best, minimized. There have been no serious reactions of the type I described that have occurred since this has happened. The other thing to keep in mind is that the majority of the reactions we have seen have been due to latex gloves. This is probably due to the powder on the gloves which comes off and the latex protein getting carried into the respiratory tract leading to the reaction. There is tremendous variation from manufacturer to manufacturer as well as within a manufacturer’s product in the amount of latex which comes off a glove.

## **Question for Dr. Martone, Centers for Disease Control, U.S.A.:**

What is the role of vaccination in the transmission of tuberculosis in health care workers?

## **Answer by Dr. Martone:**

The issue of BCG vaccination in health care workers in the U.S. is a recurrent one. Until recently, it was not felt that U.S. health care workers should receive the BCG vaccination for a number of reasons. Importantly, until now, the incidence of tuberculosis has been very low and receiving BCG vaccinations would eliminate a good epidemiologic and clinical marker of recent infection for which we had very good prophylactic therapy. Since the upsurge in the number of cases of tuberculosis, and in particular with the occurrence of drug-resistant tuberculosis, the issue of whether or not to provide BCG vaccination in high-risk areas has resurfaced. This issue is currently being reexplored as a possible recommendation by the Advisory Committees on Immunization Practices and the Elimination of Tuberculosis. I don't have any preliminary information at this time as to what direction those recommendations are going.

## **Comment from the Floor:**

I would like to comment about the fact that skin testing cannot be used as a tool once BCG vaccinations are given. I do not believe that this is exactly true because a skin reaction can be quantified. If you receive a BCG vaccination you have a rather weak reaction, but if you are then exposed to tuberculosis you get a rather strong reaction which can be quantified. Among hospital workers in France a BCG vaccination is given if the skin test is negative; therefore, most workers get vaccinated. Yet it is still possible to investigate cases of exposure to patients with tuberculosis with skin testing.



## **Question for Dr. Martone:**

Do non-immunocompromised patients or staff usually proceed to a latent infection?

## **Answer by Dr. Martone:**

Exposure to tuberculosis will cause an infection that will remain latent and for most non-immunocompromised individuals will not result in infection. The risk of infection is between 5 and 10% over the course of a lifetime, most of that occurring within the first year. Receipt of INH prophylaxis for 6 months to one year will result in a marked reduction in that risk, about 1%. In patients with AIDS, however, exposure to tuberculosis will usually proceed to a fulminant, primary infection. Patients with AIDS who had prior exposure to TB before they developed HIV infection and AIDS will result in a reactivation of TB at a rate of 10%/year.

## **Question for Dr. Martone:**

How often do you recommend skin testing in health care workers?

## **Answer by Dr. Martone:**

Current recommendations are about once a year. We recommend more frequent testing in high-risk situations, approximately every 6 months. I believe that Dr. Jarvis has recommended every 4 months in some cases.

## **Comment by Dr. Jarvis:**

In some of the hospitals, we have recommended testing every 3 to 4 months in the outbreak wards.

## Question for Dr. Martone:

How long does it take to develop a positive skin test? The time graphs tend to show an instantaneous conversion.

## **Answer by Dr. Martone:**

It is usually about 4 to 6 weeks. That graph may have been misleading because there were a series of negative skin tests results.

## **Question for Dr. Martone:**

Clinicians are always pressing us to discharge patients as soon as possible. Should we wait until sensitivity tests have been completed?



## **Answer by Dr. Martone:**

It depends on the epidemiologic milieu in which you reside. A patient can be released much sooner in a situation where sensitive strains of tuberculosis are being isolated. In highly endemic multiple drug resistant hospitals, however, I think it is important to keep the patients in isolation until the sensitivity results have been obtained.

## **Comment by Dr. Jarvis:**

The current CDC guideline recommends that patients who have drug-susceptible tuberculosis can be removed from isolation when they have clinical improvement and/or their smear shows a decrease in the number of organisms. These recommendations are going to be changed. At the time you are removing or thinking of removing a patient from isolation, you generally do not know whether he/she has drug-susceptible or drug-resistant tuberculosis since susceptibility testing can take anywhere from 2 to 6 months. Therefore, the new guideline will probably recommend that no patient with tuberculosis should be removed from isolation until clinical improvement is seen and a patient has had at least three negative smears on three consecutive days.

## **Question for Dr. Meunier, European Organization for Research and Treatment of Cancer, Belgium:**

I got the impression that you were quite negative concerning the use of antifungal prophylaxis. I remember, however, that it is widely used, especially with AIDS and HIV-infected patients and there are papers proving that there is a reduction in the subsequent events in the prophylactic patient.

## **Answer by Dr. Meunier:**

I totally agree. In Europe I was one of the first to fight to get the idea of prevention across, particularly in cancer patients. In the U.S., however, there are still major oncology centers which are not convinced of the role of prophylaxis even for bacterial infections such as granulocytopenia. However, there is no single panacea which is active against all pathogens. Therefore, we still need to develop optimal modalities, and in your own clinical setting, you must choose a drug which decreases the risk of the most common types of infection.

**Session II**  
**Pharmaceutical Emerging Issues**  
**Chairman: Bryan H. Hartley**  
*U.K.*



# Opening Remarks

Bryan H. Hartley, B Pharm, FR Pharm S

*Department of Health, U.K.*

# Introduction

Four topics will be discussed in this session: aseptic processing, terminal sterilization, sterility assurance for aseptic processing, and the use of hydrogen peroxide as a decontaminant. While we all strive to achieve the same end-point, i.e., a sterile product, there are many ways of achieving this, some more reliably than others, which is where the concept of sterility assurance comes into play. With terminally sterilized products it is possible to assign a probability to sterility assurance and thus obtain a sterility assurance level (SAL). This is defined as the probability of a product being contaminated with a viable microorganism. It is not appropriate to assign a sterility assurance level for aseptically processed products because the process relies upon removal of microorganisms and prevention of contamination as opposed to microbial death rate kinetics. The Parenteral Drug Association Technical Monograph No. 2, "Validation of Aseptic Filling for Solution Drug Products" puts it very succinctly, "The level of sterility assurance attained is a cumulative function of all the process steps involved in the product's manufacture. The final level of sterility assurance claimed for the product cannot be greater than that of the processing steps providing the lowest probability of sterility." (7) To date it has not been possible to assign probabilities to all of these steps and indeed it may not even be feasible. The weakest link in the chain is the human element. Not only can a person make a simple mistake such as forgetting to put an O-ring on a filling vessel but can also make fundamental mistakes in the design, validation, and operation of equipment or processes. Both types of mistakes are, unfortunately, not uncommon and are certainly not restricted to small companies. While many aspects of aseptic processing do not have probabilities assigned to them, it has recently been possible to assign probabilities to certain environmental factors. This work can help manufacturers control certain aspects of sterility assurance to a higher degree. I believe that some of the papers in this session will take us a step forward in being able to quantify the sterility assurance for parts of the aseptic process.

In the interim, it is interesting to note a convergence of views and standards regarding aseptic processing between Europe and the U.S. The E.C. Guide to GMP states that, "Where possible and practicable, heat sterilization is the method of choice." This is similar in concept to the FDA proposed rule entitled, "Use of Aseptic Processing and Terminal Sterilization in the Preparation of Sterile Pharmaceuticals for Human and Veterinary Use."



# Aseptic Processing

Aseptic processing has enabled a number of significant medicinal products to be brought onto the market place, notably those of biological origin. Many lives have been saved and suffering alleviated because of this process. Much credit must go to the pharmaceutical industry, the filter manufacturers, and to academia for the amount of time, money, and effort expended in reducing the microbial contamination rate of aseptic products. In the space of 20 years we have moved from an average contamination rate of approximately 3 in 3000 to 1 in 10,000 units in correctly operated and controlled facilities. This contamination rate may continue to improve with the use of isolator technology, which is being embraced wholeheartedly by the pharmaceutical industry, and also by the ongoing improvements in filter technology.

One emerging issue, however, is that of aseptically processing a product that is capable of being terminally sterilized but its container is not. This raises a number of questions that cover not only sterility assurance but also user safety (i.e., from broken ampoules), patient safety (i.e., glass spicules from ampoules), convenience, and cost. Some or all of these factors may be taken into account at the licensing stage.

Looking to the future, much interesting work is currently being performed on increasing the stability of proteins to heat (2). Traditionally, proteins have had to be aseptically processed but recent work (3, 4, 6) has shown that the stability of proteins can be increased by replacing lysine residues with arginine and also by increasing the number of disulphide bridges to the molecule. The stability of glucose isomerase, which is used industrially to convert glucose to fructose under conditions of high temperatures, has been increased considerably by replacing the lysine at position 253 with arginine. Thermostability has also been improved for human copper, zinc-superoxide dismutase. Over the years this work may impact the thermostability of proteins produced by genetic engineering and thus allow such products to undergo a terminal heat treatment if not sterilization.

# Terminal Sterilization

There have been many advances over the past 20 years. Microprocessor controlled sterilizers and irradiation plants now enable fine control over the cycle thus enabling a number of thermolabile drugs to be terminally sterilized. Our knowledge about microbial death rate kinetics has increased greatly because of the commitment of industry and academia into research on this subject which has resulted in the refinement of terminal sterilization cycles.

Such is the wealth of knowledge that international standards are, or soon will be, available for ethylene oxide sterilization, radiation sterilization, and moist heat sterilization. This is not to say that problems with terminally sterilized products do not exist, however. Two main areas of concern exist. First, the integrity of the container closure system which is particularly relevant to vials. Few companies adequately control the stoppering and capping of vials and thus the integrity of the vial may be breached, particularly during the cooling stage of the sterilization cycle (see 8). Capping and sealing force transducers which monitor the process are available, as are seal force testers, yet few companies actually possess them. Secondly, defective sterilization cycles. Regardless of how new or modern an autoclave is, defective cycles can and do still occur. While most of these cycles are identified by the chamber and drain thermocouples, there have been a number of instances where they have not. It is important not to become too complacent about terminal sterilization and to ensure that all autoclaves are adequately revalidated on a regular basis.

# Hydrogen Peroxide Decontamination

Hydrogen peroxide has been used as a decontaminant in many diverse roles. It has been used to decontaminate spacecraft, in particular the Mariner Mars 1971 flyby spacecraft (11), hydrophilic contact lenses (5), and food packaging equipment and material (9,10). Its role in the pharmaceutical industry has recently been expanded to include decontamination of isolators. Recent work performed by Edwards (1) has shown that gas phase hydrogen peroxide can be an effective decontamination agent for isolator surfaces as well as for filling equipment provided that the filling system runs continuously throughout the decontamination cycle, obviously without the product being processed. The use of hydrogen peroxide as a decontaminant is bound to increase as more isolators come on stream.

# Conclusion

While considerable advances have been made in sterility assurance over the last 50 years, there is still much research ongoing, particularly with regards to aseptic processing, that may eventually enable the pharmaceutical industry to reach the ultimate goal — the absence of viable microorganisms in each and every unit produced.

# References

1. Edwards LM. Hydrogen peroxide gas sterilization of an enclosed vial filling machine. *Pharm Engineering* 1993;50-54.
2. Goodenough PW. Protein engineering. *Biologist* 1993;40(2):67-72.
3. Jenkins J, Janin J, Chiadmi et al. Protein engineering of xylose (glucose) isomerase from *Actinoplanes missouriensis*; 1. Crystallography and site-directed mutagenesis of metal binding sites. *Biochemistry* 1992;31:5449-5458.
4. Lambeir A-M, Lauwereys M, Stanssens P, et al. Protein engineering of xylose (glucose) isomerase from *Actinoplanes missouriensis*; 2. Site-directed mutagenesis of the xylose binding site. *Biochemistry* 1992;31:5459-5466.
5. Levine WL, Litskey W, Lamm RA. Disinfection of hydrophilic contact lenses with commercial preparations of 3% and 6% hydrogen peroxide. *Dev Ind Microbiol* 1981;22:813-819.
6. Mrabet NT, Van den Broeck A, Van den Brande I, et al. Arginine residues as stabilising elements in proteins. *Biochemistry* 1992;31:2239-2253.
7. Parenteral Drug Association. Technical Monograph No. 2: Validation of Aseptic Filling for Solution Drug Products.
8. The Parenteral Society. Technical monograph No. 3. The Prevention and Detection of Leaks in Ampoules, Vials and other Parenteral Containers.
9. Toledo RT, Escher FE, Ayres JC. Sporicidal properties of hydrogen peroxide against food spoilage organisms. *Applied Microbiol* 1973;26(4):592-597.
10. Wang J, Toledo RT. Inactivation of microorganisms on polyethylene exposed to hydrogen peroxide vapors in air at various temperatures. *Current Tech in Flexible Packaging* 1986;912:37-48.
11. Wardle MD, Renninger GM. Bactericidal effect of hydrogen peroxide on spacecraft isolates. *Applied Microbiol* 1975;30(4):710-711.



# **Aseptic Processing and Terminal Sterilization: European Pharmacopoeia View**

Henning G. Kristensen, Ph.D., Dr.Pharm.

*The Royal Danish School of Pharmacy, Denmark*

# Introduction

The European Pharmacopoeia standard on Methods of Sterilization (1) presents the methods and conditions of sterilization of products which can be sterilized in their final container. In addition, methods for the preparation of products which cannot be terminally sterilized are described. This standard is placed in an Annex to the Pharmacopoeia to provide guidance only. Because of decisions on a national level, however, the standard has become a mandatory requirement in many countries effecting the licensing of pharmaceutical products.



# Standards for Medicinal Products

The European Pharmacopoeia is elaborated in pursuance of the Convention on elaboration of a European Pharmacopoeia of the Council of Europe. The contracting parties decided to take the necessary measures to make the Pharmacopoeia standards applicable in their respective countries. The present number of states joining the work on the Pharmacopoeia numbers 20. This means that the Pharmacopoeia is enforced in a wider number of countries than those belonging to the EEC. Several East-European states have joined the work on the Pharmacopoeia as observers to the Commission together with Canada, WHO, and the EEC Commission. The Pharmacopoeia standards therefore have an impact upon the control of pharmaceutical products which goes far beyond the contracting states.

In the near future, the EEC Commission will become a contracting party to the Convention and will act on behalf of the EEC countries on issues which are not purely technical. The participation of the EEC Commission is a sign of the changing role of the Pharmacopoeia into a situation where its standards are elaborated to serve the industry and licensing authorities in the registration of drug products.

Until now, pharmacopoeial standards have been elaborated to serve the quality assessment of finished products by an independent controller who is not supposed to have specific knowledge about the manufacture of the product. This is the essential reason why products, claimed to be sterile, are required to meet the Test for Sterility. The policy of the Commission is to change the role of the pharmacopoeia so that its standards become an instrument in the licensing of drug products. In this light, the membership of the EEC Commission is interesting because it reflects a common interest in the development of the Pharmacopoeia.

In the past 2 years there has been an important new development in the field of standards for drug products. Collaborative work has been established between the three major pharmacopoeias in the world, i.e., the United States Pharmacopoeia, the Japanese Pharmacopoeia, and the European Pharmacopoeia. The changing role of the pharmacopoeias, with a greater emphasis on meeting the needs of industry, has stressed the importance of harmonization of the general standards of the pharmacopoeias. Collaborative work has been initiated on standards for excipients and on some technological test methods. If these first steps prove successful, we may also expect future harmonization between the pharmacopoeias in other fields.

A pharmaceutical product can only be marketed when it has been approved by national health authorities. In this process, the standards of the European Pharmacopoeia are normally applied, but in justified cases a different standard can be approved and authorized for the particular product. In brief, the Pharmacopoeia devises the standard for a raw material, for a method of analysis, or for a manufacturing method and its control. The standards of the European Pharmacopoeia are authorized by the EEC Directives on human and veterinary products. In addition to the standards, for example, the EEC Guide to Good Manufacturing Practice and its recommendations about sterilization methods and aseptic processing of pharmaceutical products are important to the industry.

There is a long tradition of rules and guidelines for the control of drug products. In the field of medical devices, a very different system has developed within the EEC. The general safety

requirements are given in the EEC Directives and different types of standards are elaborated in the regimen of CEN. The marketing of a medical device does not imply approval of the particular product by the health authorities as is the case with drug products but, dependent on the device, implies inspection or other types of control by a notified body. Standards of all types are, therefore, essential to that system, and it is understandable that they must be shaped differently from the pharmacopoeial standards and visa versa.

Therefore, the future situation for medical products in Europe is that in which there are standards for pharmaceutical products in the European Pharmacopoeia and CEN standards for medical devices. There must necessarily be a considerable overlap between the two sets of standards. For industry, harmonization of these standards is essential. A letter of understanding has been elaborated and signed between CEN and the European Pharmacopoeia Commission, but it is too early to assess whether the agreed exchange of information and draft standards will have an effect upon the substance of the standards.

# Sterile Preparations

A very important example of the need to achieve harmonization between the European Pharmacopoeia and CEN is the definition of a sterile product. According to the European Pharmacopoeia, products described as sterile are required to comply with the Test for Sterility. This is not a strong criterion. In practice it means that a sterile preparation, when tested, has to meet the test requirements. In the manufacturer's release control, alternative methods can be employed, such as the parametric release of heat sterilized products.

It is more important that the Pharmacopoeia states that, in addition to any sterilization process, a range of procedures and precautions needs to be employed in order to give a theoretical level of not more than one living microorganism in  $10^6$  sterilized units of the final product, i.e., a sterility assurance level (SAL) of  $10^{-6}$  has to be achieved by terminal sterilization. This sterility assurance level seems to be generally accepted by the European pharmaceutical industry as well as by the licensing authorities.

One of the CEN technical committees has initially proposed the same standard for sterile medical devices. By doing so, the coming CEN standard for sterile products may be more restrictive than the European Pharmacopoeia standard if it will apply to any product irrespective of whether it is terminally sterilized or not.

Products which cannot be terminally sterilized by an efficient method may not meet the  $10^{-6}$  level. Within CEN, there is an ongoing discussion on the terminology of such products. The terminology which identifies products having a probability of sterility of  $10^{-3}$  to  $10^{-6}$  should be distinct from the term "sterile" to avoid confusion. If a proper descriptive term for such products can be found, it may influence the terminology of the Pharmacopoeia too. In accordance with the European Pharmacopoeia, products that are not terminally sterilized but rather are aseptically processed and subjected to a final heat treatment can be labeled sterile. In order to avoid confusion among manufacturers of pharmaceuticals and medical devices I will, however, make the plea that a SAL of  $10^{-6}$  become accepted as the general standard for sterile preparations.

# Methods of Sterilization

According to the European Pharmacopoeia, sterilization may be carried out by one of the following methods:

- heat sterilization by saturated steam or dry heat,
- radiation sterilization, or
- sterilization by gas.

These methods and procedures can be modified provided there is demonstration of the efficiency of the modified method which involves the measurement of physical parameters as well as the use of biological indicators.

## *Saturated Steam*

Sterilization by saturated steam is the preferred method, and the reference conditions include heating at 121°C for 15 minutes. In the routine control of heat sterilization processes, parametric release is applied. It is based upon the measurement of the time-temperature profile of at least two containers and the time-pressure profile. The total lethal effect of the treatment using the  $F_0$ -concept can be assessed from the time-temperature profile and used as documentation for the process. The European Pharmacopoeia presents standardized biological indicators for heat sterilization processes (2), but it is clear that the use of bioindicators is considered only as an additional method to the measurement of the physical parameters.

## *Dry Heat*

The recommended conditions for sterilization by dry heat are 160°C for at least 2 hours, 170°C for at least 1 hour, or 180°C for at least 30 minutes. Sterilization at 140°C for at least 3 hours, for example, is likely to be applied to oily liquids, such as solutions based on vegetable oils, which cannot resist higher temperatures.

## *Radiation*

Radiation sterilization may be used for sterilization of heat sensitive materials. There is no indication of the applied dose, but instead it is stated that the absorbed dose is sufficient to attain the prescribed degree of safety for the product to be sterilized. The lack of precise information reflects a dispute among European countries at the time the standard was created about 10 years ago. Since then, a dose of 2.5 megarads (Mrad) has been practiced but it may be desirable and acceptable to employ lower doses for certain drug products, or higher doses for other products.

## *Gas*

Sterilization by gas implies sterilization by ethylene oxide and formaldehyde. Although mentioned in the Pharmacopoeia, formaldehyde sterilization is rarely accepted as an effective sterilization method by the licensing authorities.

According to the EEC Guide for Good Manufacturing Practice, ethylene oxide sterilization should only be used when no other method is acceptable. Apart from the correct conditions as to temperature, humidity, pressure cycle, and concentration of ethylene oxide, the sterilization cycle has to be monitored by a suitable biological indicator using an appropriate number of test pieces distributed throughout the load. A suitable bioindicator is in itself a problem and therefore, it is essential that the performance of the indicator is checked by positive controls.

Ethylene oxide sterilization is used less extensively by the pharmaceutical industry than by the medical device industry. Manufacturers of medical devices need to develop procedures for parametric release of ethylene oxide sterilized products. To my knowledge, parametric release has not been authorized for any pharmaceutical product in Europe to date. Ethylene oxide sterilization is typically used for the sterilization of starting materials for pharmaceutical preparations. It is not allowed within the EEC for the decontamination of herbal remedies due to the risk of gas residues. In Europe, therefore, marketed herbal products have a contamination of aerobic bacteria of up to  $10^6$ - $10^7$  spores per gram and also a high load of fungi. It is difficult to find acceptable alternatives to decontaminate herbal remedies, although one way to achieve a more acceptable level is to encourage the GMP aspects of the growing, sampling, drying, and storage of these products. A pending draft for a pharmacopoeial standard suggests the acceptance of a relatively high level of microbial contamination in order to avoid the illegal use of ethylene oxide sterilization, as well as to encourage improved GMP procedures.

### *Bacteria-Retentive Filters*

As mentioned earlier, the European Pharmacopoeia devises the sterilization methods standards. Methods other than those described in the Pharmacopoeia can be authorized for a particular product, however, provided that their efficacy has been demonstrated and validated. An alternative method might be sterilization by filtration through bacteria-retentive filters. This method is not specified in the European Pharmacopoeia as a sterilization method, but as a means in aseptic processing.

Filtration through bacteria-retentive filters, such as membrane filters of a nominal pore size of 0.22  $\mu\text{m}$ , has been accepted by some national authorities for sterilization of specialized products (i.e., the sterilization of the large volume preparations used for hemofiltration). The filtration technology available today is likely to provide an alternative to heat sterilization of solutions. This does not imply, however, that sterilization by filtration is likely to be included among the recommended methods for sterilization. In recent years, experience on the national level have shown that the failures and products withdrawn from the market are caused by problems with filtration through bacteria-retentive filters.

# ***Aseptic Processing***

Products which cannot be sterilized in their final container are prepared under conditions designed to avoid microbial contamination, i.e., aseptic processing. The standard prescribes that the equipment, containers, and closures are subjected to an appropriate sterilization procedure as are the ingredients whenever possible. It is recommended that the aseptic processed solutions are passed through a membrane filter having a nominal pore size of 0.22  $\mu\text{m}$  or another type of filter known to have properties of a bacteria-retentive filter.

An important aspect of the manufacture of preparations which cannot be sterilized in their final container is that, in addition to aseptic processing and filtration through bacteria-retentive filters, the preparations are subjected to a final heat treatment which is consistent with the stability of the product. As mentioned previously, the resulting products may be labeled sterile.

The Pharmacopoeia standard is certainly incomplete with regards to good manufacturing practice and validation. The guidelines of the EEC Guide to Good Manufacturing Practice need to be employed.

# Conclusions

The proper processing of sterile products is largely dependent on good manufacturing practices. The role of the Pharmacopoeia in this context is to devise the standards for the commonly accepted methods of sterilization and aseptic processing. These standards should reflect the present technology and be as precise as possible. It is important that the standard gives enough flexibility to deal with particular products and particular cases, and that the standard never becomes an obstacle to improved technologies. The present standard of the European Pharmacopoeia on Methods of Sterilization largely meets these expectations.

# References

1. European Pharmacopoeia. *Methods of Sterilization*, 2nd Edition, Annex IX.1, 1983.
2. European Pharmacopoeia, *Biological Indicators for the Verification of Sterilization Procedures*, 42nd Edition, Annex IX.1.1, 1983.





# An Overview of Aseptic Processing Versus Terminal Sterilization<sup>1</sup>

R. Michael Enzinger, Ph.D. and William R. Frieben, Ph.D.

*The Upjohn Company, U.S.A.*

The FDA has recently taken the position that terminal sterilization is the sterile product manufacturing technology of choice and that aseptic processing should only be used in those cases where terminal sterilization is not feasible (6). FDA proposed that aseptic processing could be used in those cases where the drug product or the container/closure system could not withstand heating. Biologicals were also exempted because of their known sensitivity to heat. This proposal points out that a FDA analysis of recall data from October, 1981 to September, 1991 demonstrated that virtually all sterile drug products for human use that were subject to the 40 recalls for problems involving sterility assurance had been aseptically processed. It should be pointed out that aseptic processing can provide sterile products with a high degree of sterility assurance when it is performed under stringent conditions with well-defined process standards. It is our belief that the recalls noted in the FDA proposal do not represent the true capabilities of aseptic processing with regard to sterility assurance, but represent problems with how aseptic processing is being carried out in some situations.

It should be recognized that while terminal sterilization now provides a consistently high level of sterility assurance for medical products, it has not always been a reliable and reproducible process. The concerns and issues raised over the sterility assurance of products sterilized by aseptic processing is similar to the situation that occurred with large volume parenteral (LVP) drug products in the early 1970s (2). Recalls of LVPs occurred due to concerns over their sterility assurance and evidence suggested that the problems were attributed to deficiencies in the terminal sterilization process. The technology of terminal sterilization was not abandoned, however. Instead, specific criteria for the design, performance, monitoring, and validation of terminal sterilization by steam were developed and implemented to improve the technology and make it a more reliable and reproducible process. In the past 10 years similar activities have begun to occur in companies using aseptic processing. Activities such as use of high-speed, in-line filling operations that integrate container washing, sterilization, filling, and sealing operations into one continuous, straight-line process minimize human intervention and product exposure to the manufacturing environment.

Advances in aseptic processing are characterized by mechanical improvements to processing equipment such as sterilize in-place techniques to eliminate or reduce aseptic connections; use of form, fill, seal technologies that significantly reduce environmental exposure time; use of barrier systems that prevent interchange between the protected and unprotected environment; use of process automation such as robotics to minimize or eliminate human intervention; design of equipment and facilities so that equipment can be maintained without personnel entering the cleanroom; and finally use of micro-environment processing which protects critical segments of the line from both the environment and human interaction in

order to prevent product contamination (Table I). These activities will continue to further improve the sterility assurance of aseptic processing operations.

**Table I. Advances In Aseptic Processing**

---

Minimize or Eliminate Human Intervention

- High speed, continuous lines
  - Sterilize in-place equipment
  - Elimination of aseptic connections
  - Form-fill-seal
  - Barrier systems
  - Process automation
  - Non-sterile side maintenance
  - Micro-environment processing
- 

Sterility assurance of aseptic processes can also be enhanced by utilization of preservatives or adjunct processing procedures after aseptic filling. Processing such as tyndallization, pasteurization, and high temperature short-time techniques may be acceptable in eliminating all but the most heat resistant of organisms. Patient protection may be further enhanced by the establishment of formulation characteristics which prevent microbial growth, such as lyophilization and dry powder dosage forms, or through the use of high osmotic pressure, pH, or co-solvents.

The decision as to which sterile product manufacturing technology to use — terminal sterilization or aseptic processing — is a complex one involving consideration of many factors since the safety and efficacy of a sterile product can be affected by the choice of manufacturing technology. One needs to select a technology that provides acceptable sterility assurance without jeopardizing the chemical, physical, or pharmacological properties of the formulation throughout its shelf life. In deciding on which process to employ, the manufacturer must evaluate which process provides a product with the highest total quality. For example, terminal sterilization may provide a high level of sterility assurance for a product in its final container. However, all methods of terminal sterilization require the input of substantial amounts of energy which can adversely affect the critical quality parameters of many products.

Aseptic processing has a less detrimental effect on the formulation and package, but is more vulnerable to random events of contamination. The sterility assurance of aseptic processing has improved significantly in the past 10 years, however. Because of these improvements, other factors need to be considered in the decision to employ aseptic processing or terminal sterilization. As summarized in Table II, both processes have their inherent advantages and disadvantages. One must be careful not to overlook the negative aspects of terminal sterilization in favor of the level of sterility assurance it provides. Indeed, sterility assurance must be weighed against other key product quality attributes such as increased product degradation, an increase in particulates, adverse effect on physical characteristics of suspensions, increased extractables or impact on integrity of containers/closures, limitations in packaging due to effects of heat, adverse chemical interactions in the formulation affecting

efficacy or safety, and increased variability of key chemical and physical attributes among and between lots. It is important that all key product quality attributes are considered in selecting a sterile product manufacturing technology.

**Table II. Characteristics of Sterilization**

Characteristic	Terminal Sterilization	Aseptic Processing
Sterility assurance	Greater	—
Product degradation	Greater	—
Particulate formation	Greater	—
Effect on physical properties	Greater	—
Effect on closure extractables	Greater	—
Adverse effect on container/closure	Greater	—
Packaging flexibility	—	Greater
Effect on chemical properties	Greater	—
Effect on interlot and intralot chemical and physical variability	Greater	—

What are the sterility assurance capabilities of aseptic processing? As early as 1974 one company reported an average sterility assurance of  $2 \times 10^{-4}$  as measured by media fill for its aseptic processing operations (4). Aseptic processing has changed considerably since then, however. New aseptic processing technologies have emerged that are capable of minimizing or eliminating human intervention to a greater extent than in the past. Aseptic processes are capable of providing sterility assurance levels (SALs) that approach those of the regulatory requirements applied to terminal sterilization. For example, several investigators (1,3,5) have demonstrated that aseptic processing is capable of providing SALs of  $10^{-5}$  to  $10^{-6}$  as measured by media fills.

Sharp showed in two different studies that form, fill, seal technologies provided a high level of sterility assurance (5). At Boehringer Ingelheim (UK) the positive rate by media fill was 1 in 111,000 units during 18 separate runs (Table III), and with Waverly/Steripak (Table IV) there was a positive rate of 3 in 276,000 units during 43 separate runs (5). In addition, at Upjohn we have filled approximately 186,000 units in 26 separate media fill runs on an in-line, high speed filling operation. Only one non-sterile unit has been found for an overall estimated SAL of  $5.4 \times 10^{-6}$ .

**Table III. Capabilities of Aseptic Processing**

Boehringer Ingelheim (UK) Media Fills (July 88 to July 89)<sup>1</sup>

M/c No.	No. of Runs	Total Units Filled and Incubated	Units Showing Growth Total
1	14	87,680	1
2	4	23,590	0
<b>Totals</b>	<b>18</b>	<b>111,270</b>	<b>1</b>

**Table IV. Capabilities of Aseptic Processing**

Waverley/Steripak — Media Fills (August 1987 to September 1989)<sup>1</sup>

M/c No.	No. of Runs	Total Units Filled and Incubated	Units Showing Growth Total
AR2	12	72,000	1
AR3	6	36,000	0
AR4	7	42,000	0
AR5	6	36,000	1
AR6	3	24,000	0
AR7	4	30,000	1
AR8	5	30,000	0
Totals	43	276,000	3

<sup>1</sup> Sharp JJ. Aseptic Validation of a form/fill/seal installation: Principles and practice. Par Sci Tech 1990;44(5):289.

The concept “estimated sterility assurance level” for aseptic processing needs to be qualified. With terminal sterilization, sterility assurance is estimated by application of the lethality equation:

$$F_0 = D (\log A - \log B)$$

$$B = \text{Sterility Assurance} = \log^{-1} A - F/D$$

One estimates sterility assurance by solving for B. The validity of this estimate is based on the assumption that first order death kinetics apply, allowing extrapolation of microbial inactivation over several orders of magnitude.

With aseptic processing the best available method for estimating sterility assurance is the media fill test. The validity of the estimate is dependent on the:

- degree that the media fill simulates the manufacturing process;
- degree that contaminating organisms capable of surviving in product also grow in media;
- degree of bias introduced by personnel due to the knowledge that they are being tested; and
- degree that the process is reproducible from day-to-day.

It is our belief that estimated SALs determined with media fills represent a worst case estimate of an aseptic processing operation since the media is growth promotive. In contrast, small volume parenterals are often inimical to microbial growth/survival due to the presence of antimicrobial preservatives or hostile formulation characteristics. Hostile formulation characteristics can play a vital role in upgrading the product’s sterility assurance beyond that determined by media fill.

Summation of media fill data has been mentioned as a means to estimate sterility assurance when a process has been conducted a number of times. The validity of the estimate

is dependent on the degree of reproducibility inherent in the process. As the reproducibility improves so does the estimate derived from summation of media fills. Of the two processes represented in Figure 1, the graph on the left represents a non-reproducible process. The summation of media fill result of this process would have a large variation and would not be a good estimate of sterility assurance for any specific run. The right graph represents a reproducible process. In each case there is a positive result which is represented by one contaminated unit per 6,000 units. As stated previously, the validity of the media fill average as an estimate is dependent on the reproducibility of the process. The average media fill result would be a valid estimate of the sterility assurance for the process represented in the right graph given that the media fill test adequately simulates the process.

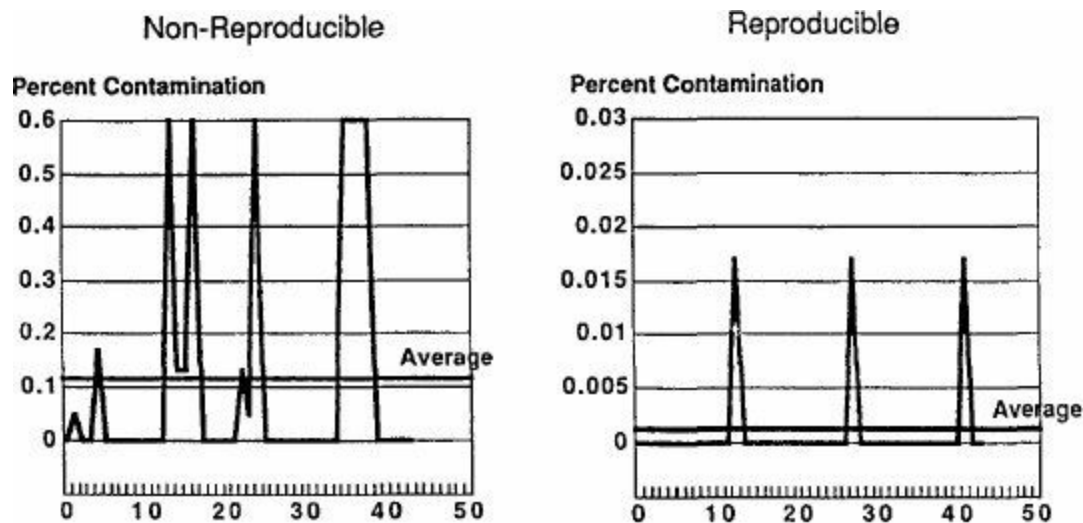

Figure 1. Media Fill Tests

The technical advances in aseptic processing tend to diminish the sharp difference in SALs between aseptic processing and terminal sterilization. However, improvement is still needed in the measurement of the higher levels of sterility assurance resulting from the improvements in aseptic processing. It may be impractical to continue to rely upon media fill challenges alone to assess these improved SALs because it is not feasible to manufacture several hundred thousand units in a media fill test in order to empirically determine the sterility assurance. One could sum historical data on media fills, but this might require a long period of time to accumulate a sufficient number of units. Media fills must also meet the previously stated criteria. There is a need for an evaluation and acceptance of one or more mathematical models to assess the improved sterility assurance levels of advanced aseptic processing operations.

How would one estimate sterility assurance capabilities of aseptic processing? One example is William Whyte's proposed sterility assurance model (Table V) that estimates contamination rate by the number of particles that may enter a container from the air (7). This model takes into consideration the concentration of microorganisms in the air, equivalent particle diameter, the area of the container opening, and the time the container is open. An important assumption with this model (and presumably any model we would use) is that human intervention is removed. This model does not account for potential contamination at critical sites due to human intervention. Empirical verification of this model at several sites will be necessary in order to confirm its validity.

**Table V. Whyte's Sterility Assurance Model**

---

$$\text{Contamination Rate} = 0.032D^2CA_NT$$

Where:

d = The equivalent particle diameter, i.e., 5  $\mu\text{m}$

c = Airborne microorganism concentration per  $\text{cm}^3$

$A_n$  = The area of the container neck ( $\text{cm}^2$ )

T = The time the neck is open (sec.)

---

A second approach could be to empirically determine the contamination rate caused by a high airborne concentration of challenge microorganisms and then extrapolate the estimated SAL when the airborne concentration of microorganisms was reduced to the level expected in controlled environments. Figure 2 presents data from Bradley's study (1) showing product contamination rate as a function of airborne concentration of microorganisms. The objective of this study was to show a relationship between the level of airborne microorganisms in the environment (X axis) and product contamination rate (Y axis). To achieve this end, controlled challenges of microorganisms dispersed in the air were generated within a containment room housing ampoules filled with medium that supported the growth of the challenge microorganisms.

At a challenge of  $10^4$  spores/ $\text{M}^3$  the product contamination rate was  $10^{-3}$  (with air shower on) and at  $10^7$  spores/ $\text{M}^3$  the product contamination rate was greater than  $10^{-1}$ . When the curves were extrapolated to lower challenge concentrations they estimated that a challenge below  $10^2$  spores/ $\text{M}^3$  (air shower on) produced a sterility assurance between  $10^{-5}$  and  $10^{-6}$ .

There would be fundamental obstacles in using this approach on a routine basis due to the requirements to introduce large populations of viable organisms into the cleanroom. It is conceivable, however, that this approach could be used on a restricted basis to test William Whyte's model under a variety of cleanroom conditions.

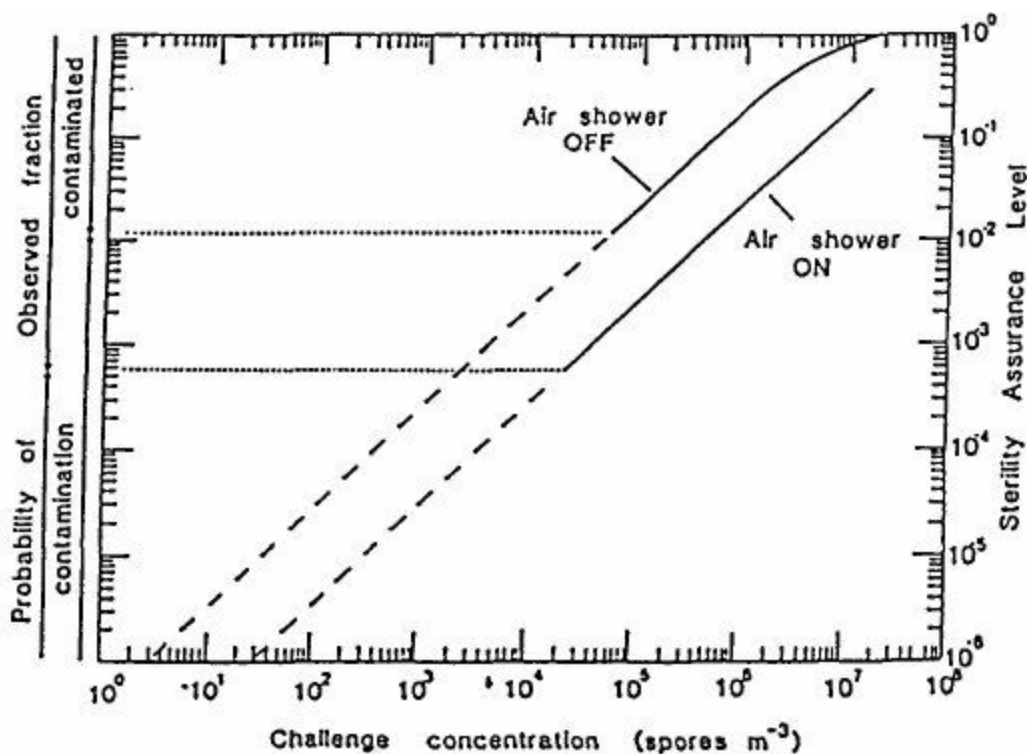

Bradley A, Probert SP, Sinclair CS, Tallentire A. Airborne microbial challenges of flow/fill/seal equipment: A case study. *J Par Sci Tech* 1991;45(4):187.

Figure 2. Extrapolation of Experimentally Derived Curves

In summary, the decision of which sterile processing technology to use, aseptic versus terminal, is a complex one and all key product quality attributes need to be considered. One needs to select a technology that provides acceptable sterility assurance and provides a product of the highest total quality. One also needs to consider that heat can adversely affect product quality in terms of drug degradation, particle generation, adverse suspension characteristics, increased extractables, effect on container/closure integrity, packaging flexibility, chemical properties, preservative degradation, and interlot and intralot chemical and physical variability.

In conclusion, aseptic processing has sterility assurance capabilities considerably better than  $10^{-3}$ . In fact, by minimizing human intervention and environmental exposure, advanced aseptic processing can meet sterility assurance guidelines that would be acceptable to regulatory agencies. Under these conditions, the sterilization strategy, whether it be terminal sterilization or aseptic processing, should take into consideration the manufacturer's knowledge of product characteristics, sterilization capabilities, and economics of sterile product manufacturing.

Terminal sterilization would be the process of choice with heat-stable products (Table VI). However, most pharmaceuticals are not heat-stable and important quality attributes will be adversely affected by heat. For this reason, we suggest that aseptic processing be considered for heat sensitive and most non-growth promoting formulations. Non-growth promoting formulations include lyophilized, dry powder, non-aqueous, or even cidal aqueous formulations.



## Terminal Sterilization:

- heat stable product

## Aseptic Processing:

- heat sensitive product
  - non-growth promoting formulations
  - lyophilized
  - dry powder
  - non-aqueous
  - aqueous cidal formulations
- 

Given the sterility assurance capabilities of well controlled advanced aseptic processes and the adverse effects of heat on product quality, we believe that aseptic processing will frequently become the process of choice.

# References

1. Bradley A, Probert SP, Sinclair CS, Tallentire A. Airborne microbial challenges of blow/fill/seal equipment: A case study. *J Par Sci Tech* 1991;45:187.
2. Current Good Manufacturing Practice in the Manufacture, Processing, Packaging, or Holding of Large Volume Parenterals. *Fed Reg* 1976;41(106):22202.
3. Leo F. Blow/fill/seal aseptic packaging technology. In: Olson WP, Groves MJ, eds. *Aseptic Manufacturing Technology for the 1990's*. Prairie View, Ill: Interpharm Press Inc.; 1987; 195.
4. Raiman HL. Microbiological environmental monitoring. *Bull Par Drug Assoc* Nov.-Dec. 1974;28:253-260.
5. Sharp J. Aseptic validation of a form/fill/seal installation: Principles and practice. *J Par Sci Tech* 1990;1(44):289.
6. "Use of Aseptic Processing and Terminal Sterilization in the Preparation of Sterile Pharmaceuticals for Human and Veterinary Use," *Fed Reg* 1991;56(198):51354.
7. Whyte W. Sterility assurance models for assessing airborne bacterial contamination. *J Par Sci Tech* 1986;40:188.

---

<sup>1</sup> Parts of this manuscript were previously published in *Journal of Parenteral Science and Technology*, "Sterile Product Manufacturing Technology", 1992;46(3).



# **Predictive Sterility Assurance For Aseptic Processing**

Colin S. Sinclair, Ph.D. and Professor Alan Tallentire

*University of Manchester, U.K.*

# Introduction

Terminal sterilization and aseptic processing constitute the two principal methods of manufacture of sterile pharmaceutical products. Of these two methods, aseptic processing has become associated more often with sterility failure. Inevitably, this has led aseptic processing to be placed under considerable scrutiny from Regulatory Authorities, none more so than the Food and Drug Administration. Authorities have increasingly expressed the view that the sterility assurance of products processed by aseptic methods must be improved in order to reduce the risk of public harm (1).

Conventional methods to estimate sterility assurance for products prepared by aseptic processing are based upon 'medium-fill' studies. Typically in such a study, sterile microbial growth medium is processed through the entire manufacturing and filling operation, followed by incubation of the final product and subsequent examination for bacterial growth (2). Routinely, at least 3,000 units are filled to detect a contamination rate of not more than one contaminated unit per thousand units filled. The resultant estimate of contamination level of  $10^{-3}$  compares unfavorably with a sterility assurance level (SAL) of  $10^{-6}$  targeted for products processed by terminal sterilization. However, it is often claimed that advanced aseptic processing technologies which eliminate or minimize human intervention can achieve contamination rates considerably lower than the usual target rate of 1 in 1,000. To test the validity of such claims, a new approach to estimating sterility assurance for aseptic processing is essential.

Blow/Fill/Seal processing is a fully automated technology that is designed to be operated remotely when contained within a controlled environment. Thus it is an ideal test system for examination of the relationship between the extent of product contamination by airborne microorganisms during medium-fill studies and the level of airborne microorganisms in the environment. Moreover, noting experimentally how changes in operating conditions influence the level of product contamination may well provide a better understanding of the manner in which processing factors impact the microbiological quality of products. Given this understanding, prediction of sterility assurance for aseptic processing becomes a realizable goal.

This article describes a series of experiments (designated Study 2) that are a follow-up to earlier published work describing Study 1 (3). Together, these two studies are aimed at defining the exact relationship between fraction of product contaminated and level of microbial challenge over an extensive range of challenge concentrations for Blow/Fill/Seal processing operating under a particular set of conditions. Study 2 was designed to examine whether the mode of air shower operation, variation in production cycle time, and 'interventions' may produce discernible effects on the fraction of product contaminated.

# Microbiological Challenge Studies — Design Considerations

The following are certain specific problems to be considered in designing an airborne microbiological challenge test for aseptic processing.

## *Nature and Production of the Microbial Challenge*

In view of the diversity of microorganisms present in the environment and the form in which they occur, it can be justifiably argued that more than one type or species of organism should be employed in challenge studies. In choosing any organism, however, due regard must be given to non-pathogenicity, ease of production and recognition, viability, average cell size, and size distribution. Furthermore, an airborne challenge may consist of the microorganisms contained within liquid droplets, located on solid particles, or as a dispersion of discrete cells in air. For a given species of microorganism, a dispersion comprising discrete cells is made up of the particles of the smallest possible dimension for that species and is very likely the most rigorous challenge that can be devised. Logically, such a dispersion is the challenge of choice. The production of a dispersion can be achieved by aerosolization of a liquid suspension of cells into droplets of sufficiently small size that, on expansion into a gaseous fluid, instantaneous evaporation of the liquid droplet occurs, leaving the discrete cells suspended in the gas. Dispersions so formed are referred to as 'dry'. Nebulizers restricting droplet size and thus giving rise to dry dispersions have been described (4).

## *Sampling of the Microbial Challenge*

In order to estimate the concentration of the microbial dispersion used to challenge the process, there is a requirement to accurately detect, with a high degree of precision, microorganisms present in a known volume of dispersion. Quantitative detection is best achieved by making use of any one viable microorganism recovered from the dispersion to produce a visible colony when incubated on solidified growth medium. In practice, the collecting device must be able to recover microorganisms from air dispersions containing a wide range of concentrations. The characteristics, specifications, and performance of various devices for collecting microorganisms have been detailed (5). An air sampler, based upon filtration, has proven particularly useful for sampling microbial challenges over a wide range of challenge concentrations.

## *Containment of the Microbial Challenge*

In order to present the microbial challenge to the Blow/Fill/Seal machine in a controlled and reproducible fashion, it is necessary for the air-dispersed microorganisms to be contained within defined limits. However, all contained dispersions of air particles undergo decay primarily due to the influence of gravity, i.e., particles fall out (6). A form of decay known as 'stirred-settling' occurs if sufficient air turbulence is created so that, even though the dispersion is decaying under the influence of gravity, a uniform distribution of particles generally exists throughout the contained volume. Under these conditions, the rate of decay for a given

particle mass is independent of particle concentration but inversely related to the height of the containment volume (6). To maintain dispersion concentration under stirred-settling conditions, it is then necessary to balance the loss of particles from the dispersion through decay with the controlled introduction of dispersed particles into the containment volume.

# Microbiological Challenge Studies — Developmental Work

## Laboratory-Based Studies

In order to develop the basic techniques to generate controlled microbial challenges, laboratory-based studies have been carried out to investigate the production and containment of air-dispersed microorganisms.

As shown in Figure 1, a containment vessel with a volume of  $0.13 \text{ m}^3$  was constructed from sheet aluminum with the specified dimensions. Four access ports were located in the chamber walls. Two of these ports were used in charging the chamber with dispersion; the inlet port was connected directly to a modified Collison nebulizer (4), and the outlet port exhausted to atmosphere via a filter to allow equilibration of pressure within the chamber during nebulization and sampling. The two remaining ports were used for sampling purposes. An 'upward drift' electrically-driven fan ( $\sim 300 \text{ r.p.m}$ ) was positioned centrally on the base of the chamber.

Figure 2 shows the behavior of air-dispersed spores of *Bacillus subtilis* var. *niger* contained under stirred-settling conditions within this laboratory vessel. Dispersions at concentrations ranging from  $10^1$  to  $2 \times 10^6$  spores  $\text{dm}^{-3}$  were generated by a 30-minute aerosolization of spore suspensions at different concentrations ranging from  $1 \times 10^4$  to  $7 \times 10^8$  spores  $\text{cm}^{-3}$ . Following the initial 30-minute charging of the vessel, the spore dispersions were held under stirred-settling conditions, without further nebulization, and sampled at 60-minute intervals over a 300-minute period. It is clear from this Figure that spore dispersions undergo decay with a constant rate of dispersion decay over the 300-minute period (half-life of 188 minutes) with essentially the same results over a  $10^5$ -fold change in spore concentration.

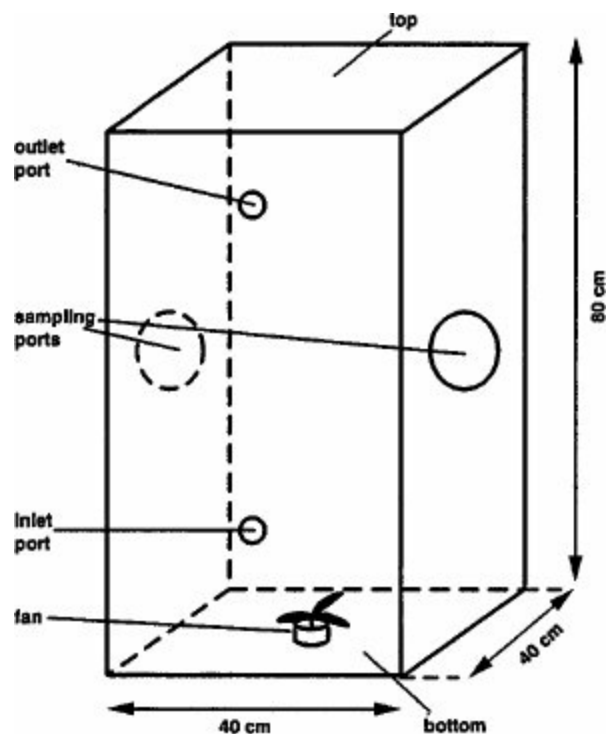

Figure 1. Schematic Representation of the Laboratory Containment Vessel



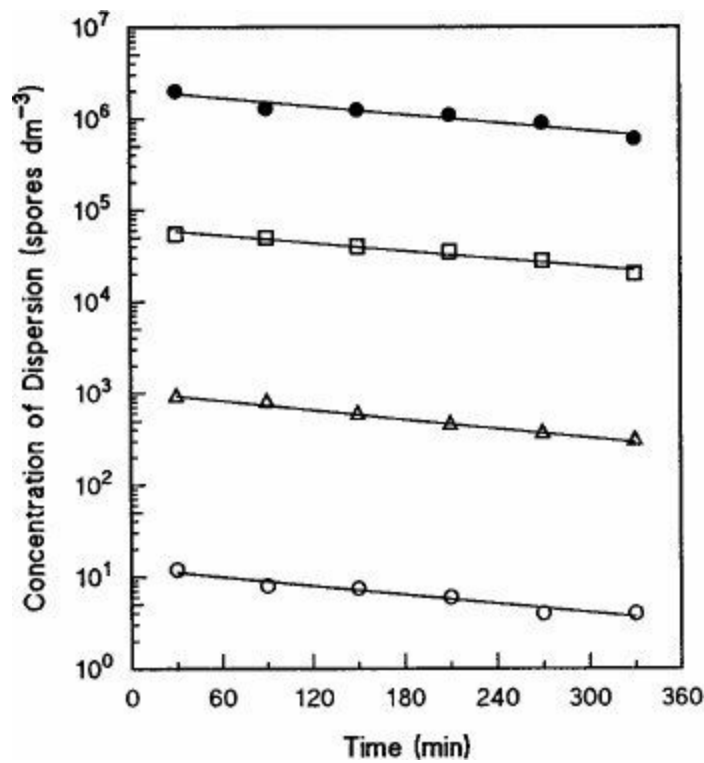

Figure 2. Stirred-Settling Decay of Spore Dispersions Held Within the Laboratory Vessel

- (○) concentration of aerosolized suspension  $1 \times 10^4$  spores  $\text{cm}^{-3}$
- (Δ) concentration of aerosolized suspension  $9 \times 10^5$  spores  $\text{cm}^{-3}$
- (□) concentration of aerosolized suspension  $4 \times 10^7$  spores  $\text{cm}^{-3}$
- (●) concentration of aerosolized suspension  $7 \times 10^8$  spores  $\text{cm}^{-3}$

The behavior of spore dispersions held within the laboratory vessel under stirred-settling conditions during the continuous aerosolization of spore suspensions at different concentrations ranging from  $1 \times 10^4$  to  $7 \times 10^8$  spores  $\text{cm}^{-3}$  is shown in Figure 3. It is evident from this Figure that, for each of the four different dispersions, the concentration of air-dispersed spores attains a plateau level after approximately 60 minutes of aerosolization, and that this level is maintained throughout the subsequent period of nebulizer operation. Furthermore, the spore concentration at the plateau level is directly related to the spore concentration of nebulized suspension. These findings demonstrate the potential of employing containment conditions of stirred-settling, coupled with continuous introduction of dispersion to the contained volume, to generate microbial dispersions of fixed and controlled concentration.

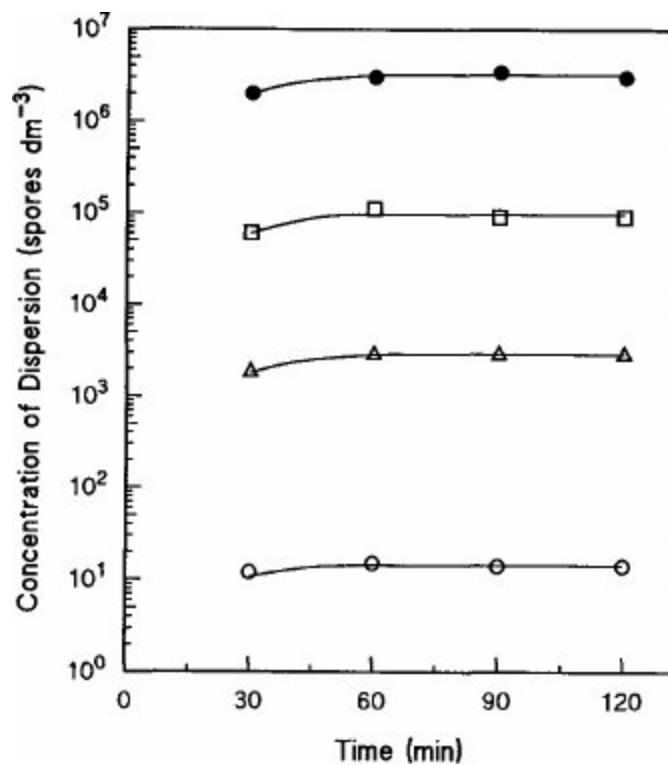

Figure 3. Spore Concentration of Dispersions Within the Laboratory Vessel During Continuous Aerosolization of Suspensions at Different Spore Concentrations

- (○) concentration of aerosolized suspension  $1 \times 10^4$  spores  $\text{cm}^{-3}$
- (Δ) concentration of aerosolized suspension  $9 \times 10^5$  spores  $\text{cm}^{-3}$
- (□) concentration of aerosolized suspension  $4 \times 10^7$  spores  $\text{cm}^{-3}$
- (●) concentration of aerosolized suspension  $7 \times 10^8$  spores  $\text{cm}^{-3}$

### Scale-Up Studies

To develop the above laboratory-based methods which allow generation and maintenance of controlled airborne microbial challenges over prolonged time periods in the environment surrounding a Blow/Fill/Seal machine, it has been necessary to initially perform a number of scale-up experiments. This work was conducted using a 'mobile cabin' modified to serve as a containment room (Figure 4); the volume of the cabin was  $24.6 \text{ m}^3$ , representing about a 190-fold increase in volume over the laboratory vessel. A sampling port was located on each of the two end walls of the cabin, Port 1 at a height of 0.5 meters and Port 2 on the opposite wall at a height of 1.5 meters. A multi-jet climbing column nebulizer (3) was positioned centrally within the cabin at a height of 1 meter; a supply line to the nebulizer ensured that it could be recharged with spore suspension during operation. Four electrically-driven 'upward-drift' fans were placed at floor level and located on diagonal axes 1 meter from each corner.

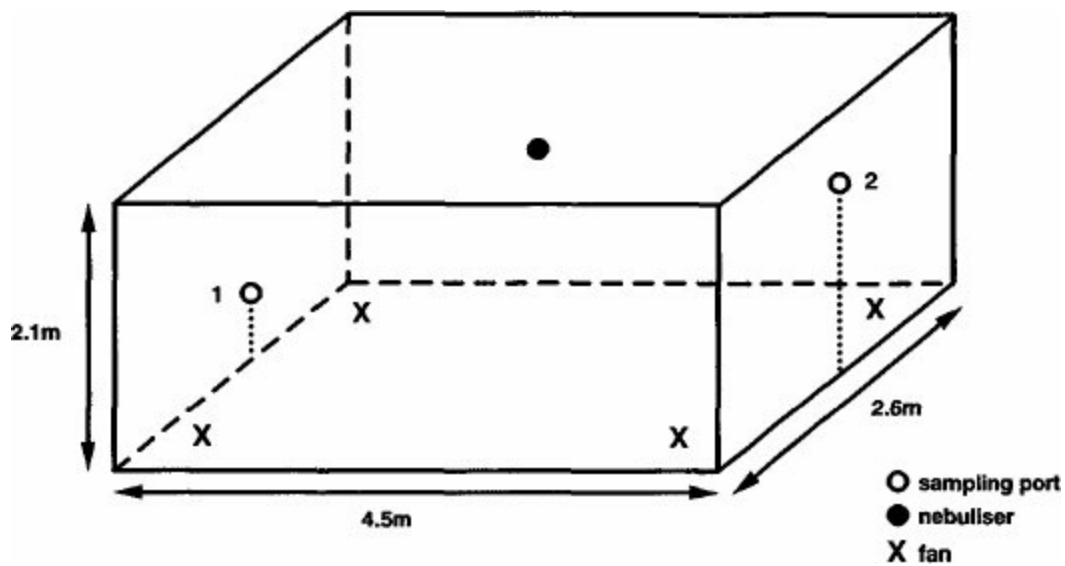

Figure 4. Schematic Representation of Modified Mobile Cabin

Figure 5 shows the behavior of a given spore dispersion held within the mobile cabin as a function of time; this particular dispersion was generated by continuous aerosolization of a  $3 \times 10^3$  spores  $\text{cm}^{-3}$  suspension. It can be seen from this Figure that, over an extended experimental period (0.5 to 9.25 hours), spore concentration as estimated at the two distant locations of differing heights, falls around a mean level of  $6.5 \times 10^2$  spores  $\text{m}^{-3}$ . The constancy of spore concentration within the room throughout the 8.75-hour experimental period provides strong evidence of the feasibility of producing controlled microbial challenges within the relatively large volume needed to enclose a Blow/Fill/Seal machine.

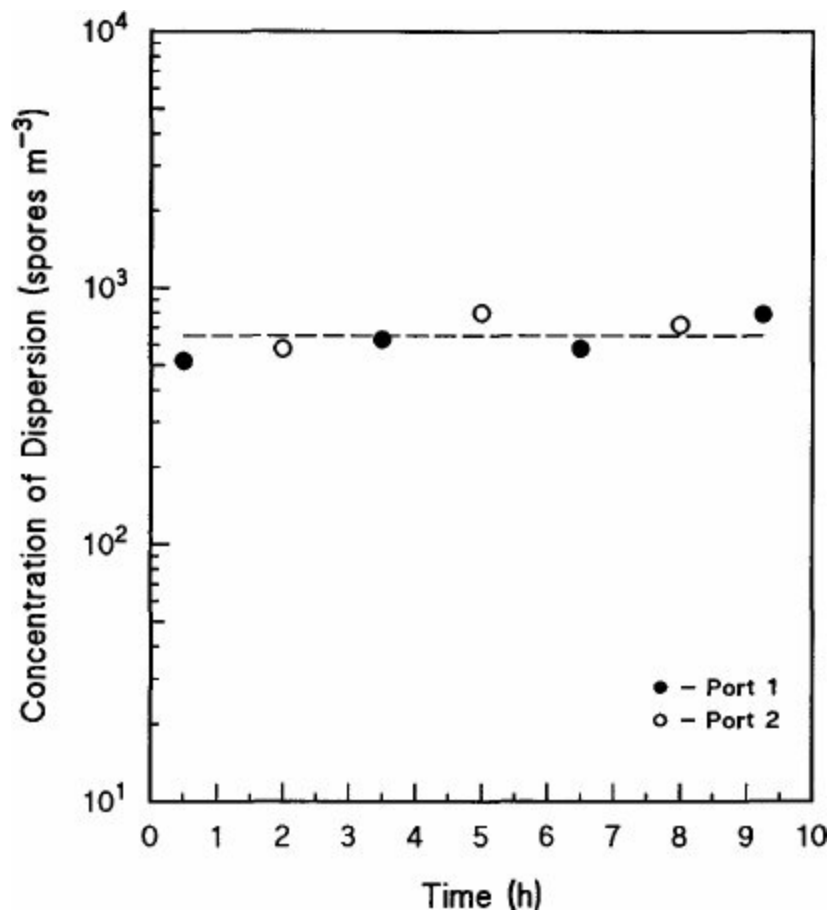

Figure 5. Estimates of Dispersion Concentration Within the Mobile Cabin Generated by Continuous Aerosolization of a Suspension of  $3 \times 10^3$  spores  $\text{cm}^{-3}$

Solid points represent estimates made at Port 1 while open points represent those made at Port 2.

# Material and Methods

## *Study Set-Up*

A previous communication (3) gave a detailed description of the experimental set-up used to generate and maintain over specified time periods controlled airborne microbial challenges in the enclosed space surrounding an operating Blow/Fill/Seal machine. The test method, basic test design, and Blow/Fill/Seal machinery used in the present work were identical to those previously described.

The containment room (67.5 m<sup>3</sup>) was sited at Weiler Engineering, Elk Grove, Arlington Heights, Chicago, a location where no sterile pharmaceutical production is carried out. Blow/Fill/Seal machine, ALP 624-017, was tooled to the same specification and mold configuration as those of ALP 624-015, the machine used in Study 1. The configuration provided 24 molded ampoules, each with a 2 cm<sup>3</sup> fill volume. The operation of the machine was identical to that used in Study 1, namely, production of 24 ampoules (1 cycle) every 12 seconds to give an overall production of 120 ampoules min<sup>-1</sup>.

The air shower unit of machine ALP 624-017, developed to provide 'local protection' of filling mandrels, was of the same basic design as previously described (3). Prior to commencement of the experimental work, the HEPA filter unit within the air shower assembly was DOP tested and rated as 99.99% efficient. By controlling the speed of the fan located in the unit, the velocity of air emerging from the air shower outlet (a slot running the length of the base of the shower enclosure) could be varied between 1.6 and 3.7 m s<sup>-1</sup>; at a given fan speed, the velocity of emerging air was found to be constant over the entire length of the slot.

For each challenge test, the Blow/Fill/Seal machine was set-up according to the machine manufacturer's protocol for 'medium-fill validation'. The fill medium used was heat-sterilized Tryptone Soya Broth, tested to meet the minimum USP fertility level. The medium was delivered to the point-of-fill after passing through two in-line liquid filters (nominal pore size 0.2 μm) that were tested for integrity at the end of each day's experimentation.

## *Microbial Challenges*

Air-dispersed spores of *B. subtilis* var. *niger* (NCIMB 8056) comprised the microbial challenge. At a predetermined concentration, aerosolization of an aqueous spore suspension gave spores dispersed throughout the air of the containment room at a given challenge concentration over the range  $3 \times 10^2$  to  $3 \times 10^6$  viable spores m<sup>-3</sup>. The test duration, during which the challenge spore concentration was maintained at a nominal level, varied according to concentration: the lower the concentration, the longer the duration. A longer test duration was required at a low spore challenge concentration to allow detection of the frequency of ampoule contamination. In practice, test durations ranged from 1 to 10 hours. The concentration of spores in the air of the containment room was monitored Intermittently during each challenge test by collecting spores present in sample volumes of air, drawn isokinetically from the room via three sampling ports (3).

## *Test Design*

Irrespective of test conditions, the following activities were carried out throughout the duration of the test:

1. continuous operation of the Blow/Fill/Seal machine employing medium-fill
2. continuous aerosolization of appropriate spore suspension
3. periodic sampling of the containment room air

In practice, a minimum of four sampling operations, comprising replicate sampling at the three access ports, were carried out for each challenge test. As previously described (3), each port was positioned at a selected location on one of three walls of the containment room, i.e., east (E), south (S), and west (W). For a given challenge test, the spore challenge concentration is the mean value of spore concentration derived from individual estimates of concentration made at the different sampling locations during the test time.

Immediately after production, all ampoules were incubated at 30-35°C for 14 days so that contamination of ampoules could be assessed by appearance of visible growth. To allow measurement of fraction of product contaminated, expressed in terms of the ratio of number of contaminated ampoules to total number of ampoules produced, each individual ampoule was identified relative to time of production and filling location.

# Results

## *Stability and Uniformity of the Spore Challenge*

The challenge concentration generated by nebulization of a spore suspension containing approximately  $6 \times 10^7$  spores  $\text{cm}^{-3}$  has been chosen to illustrate the general findings when spore challenges were generated within the contained environment housing an operating Blow/Fill/Seal machine.

Figure 6 is a plot of the estimates of the concentration of spores in the containment room air sampled at the three different locations (E, S, and W) against time covering the entire challenge period (530 minutes). Aerosolization of the spore suspension commenced at  $t = 0$  minutes and was maintained throughout the entire challenge period. Estimates of spore concentration were made at the three different sampling locations at  $t = 30$  minutes, and at regular intervals ( $\sim 30$  minutes) throughout the challenge period. It is evident from Figure 6 that, at each sampling occasion, the three estimates of spore concentration fall within a 2-3 fold range; this relatively narrow range indicates active dispersal of spores throughout the air within the containment room to give rise to a reasonably homogenous distribution. It can also be seen from this Figure that the spore concentration of dispersion was maintained at a fixed level (around  $3 \times 10^6$  spores  $\text{m}^{-3}$ ) over the challenge time extending from 30 to 530 minutes. As in the earlier study (3), the first 30 minutes of aerosolization were excluded from the challenge period as this period was utilized to establish the concentration of dispersed spores within the containment room.

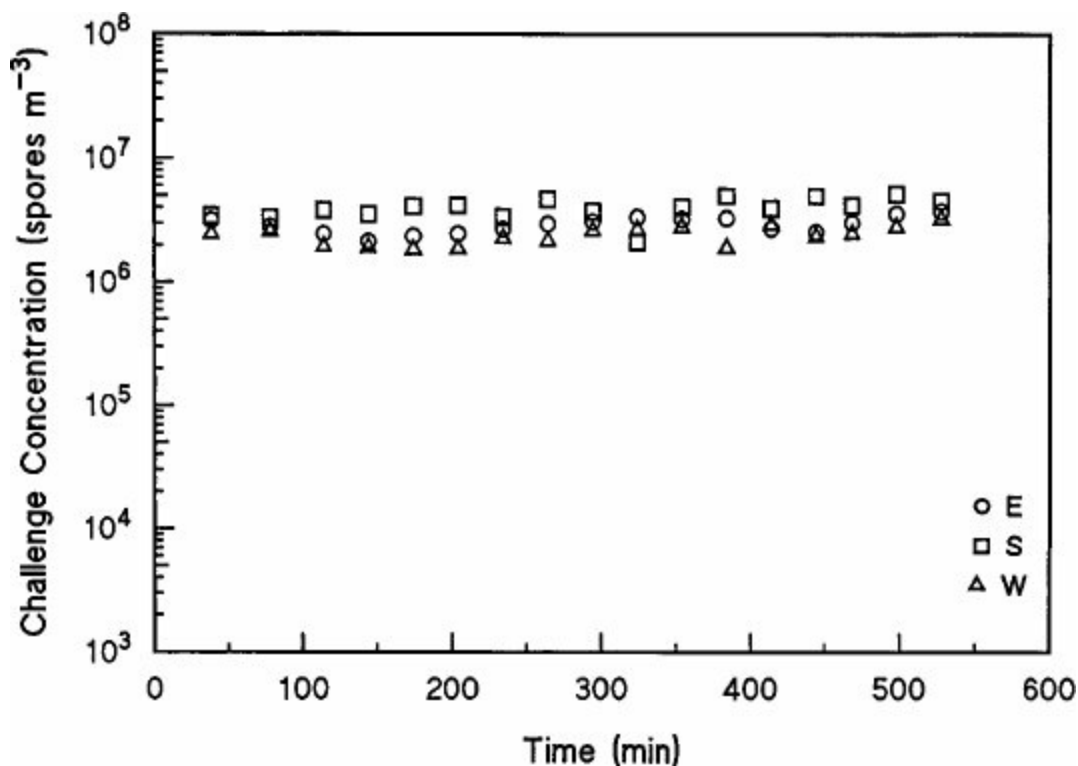

Figure 6. Estimates of Dispersion Concentration Made at the Three Sampling Ports (East [E], West [W], South [S]) of the Containment Room During Aerosolization of a Suspension of  $6 \times 10^7$  spores  $\text{cm}^{-3}$

## Relationship Between Fraction of Product Contaminated and Microbial Challenge Level

Figure 7 is a plot, on a logarithmic scale, of fraction of contaminated ampoules against spore challenge concentration for the Blow/Fill/Seal machine operating without the air shower functioning. The four closed points represent data generated in Study 2, whereas the three open points represent previously reported data generated in Study 1 (3) using the identical machine specification and operating conditions. It is immediately evident that both sets of datum points fall around the same curve (the dashed line is the extrapolation of the curve to lower levels of product contamination). Datum points from both studies comprehensively define the form of the relationship between fraction of product contaminated and level of spore challenge concentration over a 50,000-fold range of spore concentration. Moreover, the datum points show that the linear portion of the curve defining the direct relationship is experimentally demonstrable, and holds over an approximately 7,000-fold change in challenge concentration.

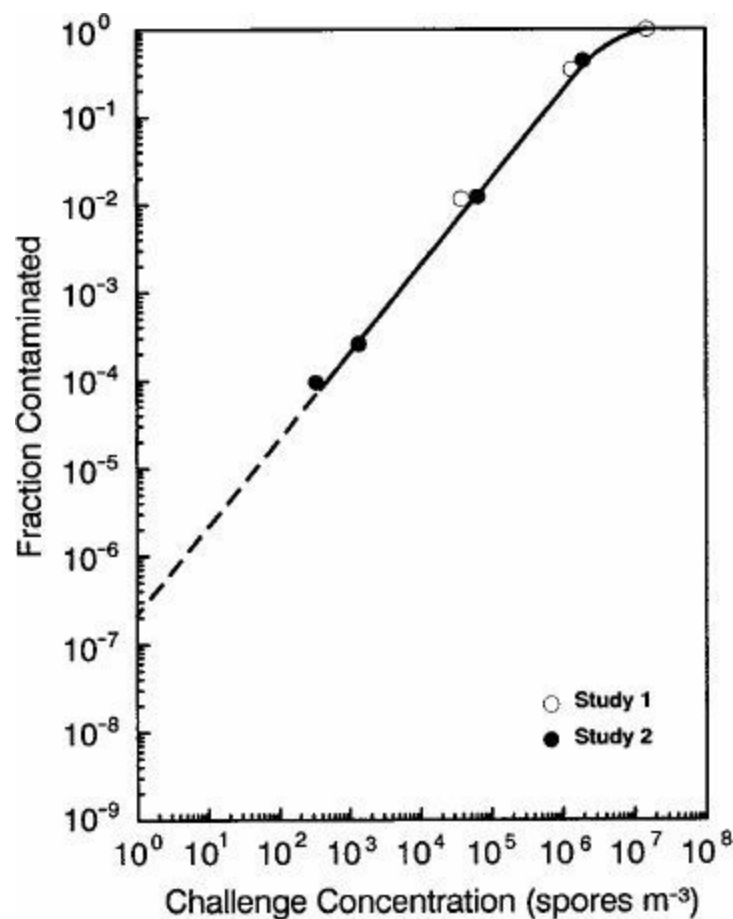

Figure 7. Fraction of Contaminated Ampoules as a Function of Spore Challenge Concentration for the Blow/Fill/Seal Machine Operation Without the Air Shower Operating

Dashed line is extrapolate of the curve.

## Operation of Air Shower

Data generated for the Blow/Fill/Seal machinery operating with the air shower at maximum setting (open points represent data generated in Study 1 and solid points represent data



generated in Study 2) is shown in Figure 8. The uppermost curve and its extrapolate depicted in Figure 8 represent the common behavior defined by data generated in both studies with the air shower off (taken from Figure 7). These plots reveal that, for each study, there is a distinct relationship between fraction of product contaminated and spore challenge concentration with the air shower operating maximally. Furthermore, the two curves derived with the air shower operating at maximum setting and the common curve derived with the air shower off are, in effect, parallel. However, the two curves generated with the air shower operating maximally are shifted downwards from that seen without the air shower operation, the magnitude of this shift being approximately 9- and 70-fold for machines employed in Study 1 and Study 2, respectively.

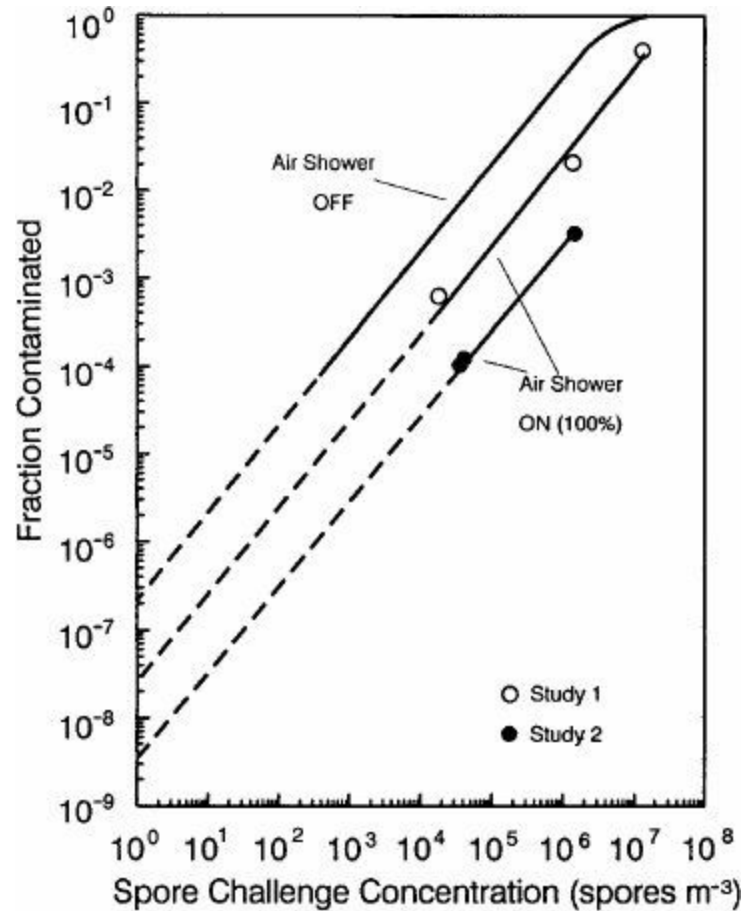

Figure 8. The Relationships Between Fraction of Contaminated Ampoules and Spore Challenge Concentration for the Blow/Fill/Seal Machine Operating with the Air Shower at Maximum Setting for Study 1 and Study 2

Dashed lines are extrapolates of the two curves; the uppermost curve and its extrapolate are the common behavior seen with air shower off (taken from Figure 7).

### *Variation in Cycle Time*

Production using Blow/Fill/Seal technology is an incremental process. The production cycle comprises container molding, filling, sealing, and discharging of product, with transfer of molded container(s) from the molding station to the filling station being achieved via a mold carriage which, at the end of the cycle, returns to the molding station. In the present study,

adjustment in cycle time was achieved through changing the period of time taken for the mold carriage to move from the molding station to the filling station; the filling, sealing, and returning of mold carriage elements of the cycle were held constant.

At cycle times of 12 and 14 seconds, determinations were made of the fraction of ampoules contaminated for the Blow/Fill/Seal machine (Study 2) with air shower both off and operating maximally. The upper solid line of Figure 9 is the curve, originally depicted in Figure 7, relating the fraction of product contaminated and level of spore challenge concentration for a cycle time of 12 seconds without the air shower operating, and the lower solid line (taken from Figure 8) is the curve for the same cycle time derived in Study 2 with the air shower at maximum operation; these two lines are given for comparative purposes. The two datum points represent the findings obtained with a 14-second cycle time, the closed point indicates the air shower off and open point indicates the air shower on at maximum. As observed, each datum point falls above the corresponding curve generated for a cycle time of 12 seconds; the magnitude of the displacement is small for air shower off but is approximately 20-fold greater for air shower operating maximally.

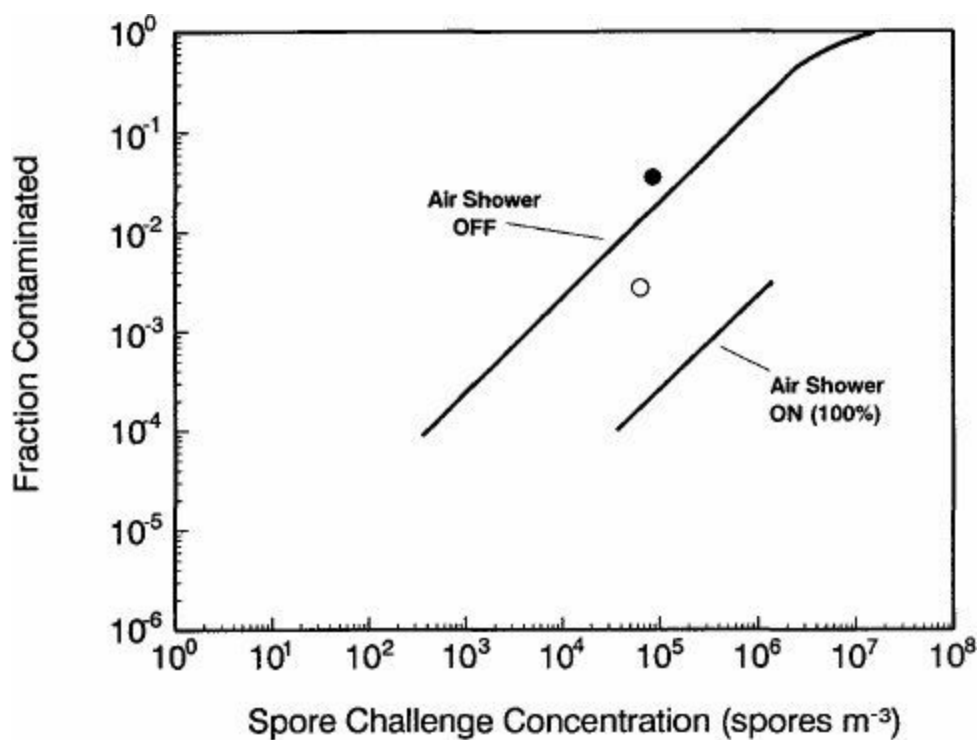

Figure 9. Datum Points Generated for the Blow/Fill/Seal Machine Functioning With a 14-Second Cycle Time

The closed point indicates the air shower off and open point indicates the air shower on; the upper solid line is the curve for a cycle time of 12 seconds with air shower off (taken from Figure 7) and the lower solid line is the corresponding curve for 12-second cycle time with air shower operated maximally (taken from Figure 8).

### Simulated Interventions

At a given spore challenge concentration (nominally  $3 \times 10^6$  spores  $m^{-3}$ ), two gross interventions were simulated through switching the air shower off from maximum setting (in so

doing, compromising local protection of the filling mandrels) and then, after a fixed time period (5 or 15 minutes) switching the air shower back on to maximum. Figure 10 is a plot of the fraction of contaminated ampoules observed in each successive five production cycles (~1-minute production) throughout the challenge period (330 minutes). The two sets of dashed lines delineate the boundaries of the two intervention periods of 5- and 15-minute duration, designated X and Y, respectively, and values in parentheses give the overall fraction of contaminated ampoules during the experimental periods before intervention X, between interventions X and Y, and after intervention Y.

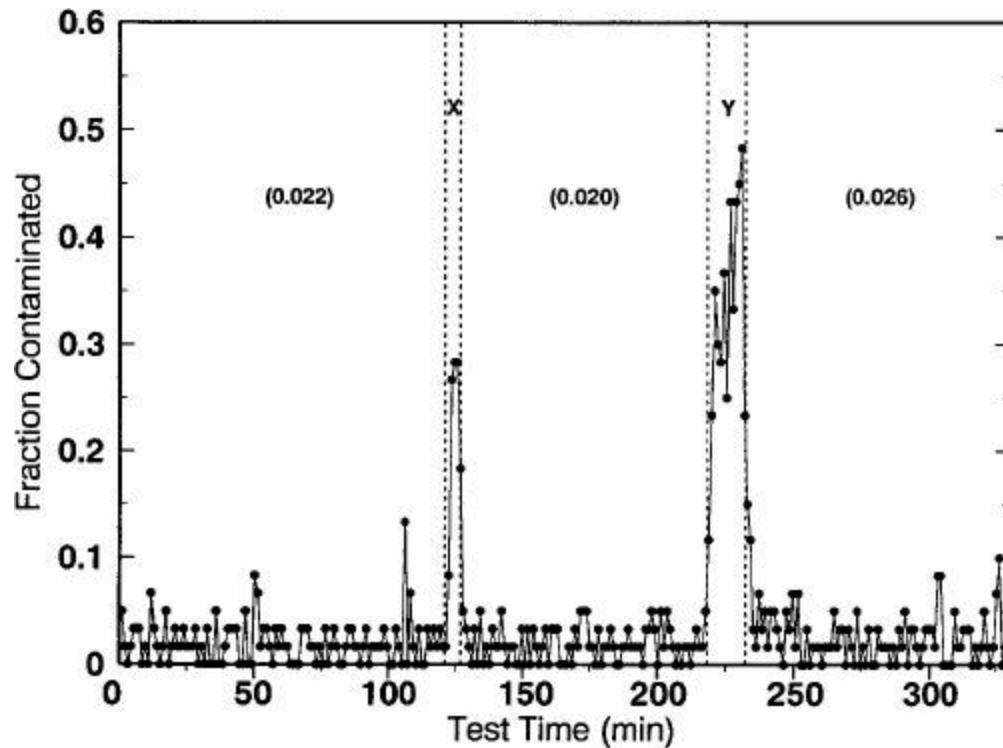

Figure 10. Fraction of Ampoules Contaminated for Increments of Five Production Cycles Throughout the Experimental Period Covering the Two Simulated Interventions (X and Y)

Intervention is defined as the time during which air shower was switched off from maximum setting. The dashed lines delineate the boundaries of the two interventions of 5- (X) and 15-minute (Y) duration.

It can be seen from Figure 10 that, prior to the first intervention X, the fraction of ampoules contaminated, at production intervals of five cycles, fell within the range 0 to 0.13, the overall fraction of ampoules contaminated throughout this first period (test time 0 to 121 minutes) was 0.022. At the start of intervention X (test time 122 minutes) switching off the air shower was seen to have an immediate impact on the fraction of ampoules contaminated, the level increased to a maximum of 0.28 (around a 13-fold increase above the mean contaminated fraction that existed prior to intervention X). At the end of intervention X (test time 127 minutes) restarting operation of the air shower was seen to bring about an immediate fall in the fraction of contaminated ampoules; within one 5-cycle increment of production (corresponding to 1 minute), the fraction fell to a level within the pre-intervention range. For the period following intervention X up to the start of intervention Y (test time 128 to 217

minutes), the overall fraction of ampoules contaminated was 0.020. This level did not differ significantly ( $p = 0.05$ ) from the level of 0.022 recorded prior to simulated intervention X, demonstrating that machine performance, in terms of fraction of product contaminated, fully returns to the pre-intervention level.

As indicated in Figure 10, a similar behavior for intervention Y is seen with a duration of 15 minutes (test time 218 to 233 minutes). Again, switching off the air shower (start of intervention Y) is observed to bring about an immediate increase in the frequency of ampoules contaminated; in this instance, the fraction contaminated attains a maximum level of 0.48 (around a 22-fold increase above the original pre-intervention level). On restarting the air shower (end of intervention Y), the fraction of ampoules contaminated is again observed to fall rapidly to pre-intervention levels. Following the simulated intervention of 15 minutes, however, the minimum time required to achieve pre-intervention contamination levels is approximately 3 minutes. For the test period following intervention Y (test time 234 to 330 minutes) the overall level of fraction of ampoules contaminated was 0.026. Again, this level did not differ significantly ( $p = 0.05$ ) from that recorded prior to the two simulated interventions, indicating full recovery of machine performance.

# Discussion

The experimental approach underlying the present fundamental investigation of automated aseptic processing has been to establish, over extended time periods, controlled challenges of air dispersed spores distributed throughout the environment within which the Blow/Fill/Seal machine operated. To set a spore challenge concentration within the operating environment, it was necessary to balance the rate of production and the rate of loss of air-dispersed spores. This balance was achieved by continuous aerosolization of spore suspension at a predetermined rate and by regulating dispersion decay via stirred-settling conditions in the containment volume around a machine. Under these experimental conditions, controlled challenges of air-dispersed spores were generated over a wide range of spore concentrations through aerosolization of spore suspensions at different spore concentrations. In practice, it has been possible to generate controlled challenges at spore concentrations extending over a 50,000 fold range for periods of time ranging up to 10 hours.

The results of Study 2, in which an operating Blow/Fill/Seal machine was challenged with air-dispersed spores, again unequivocally demonstrated that the quality of the microbiological environment surrounding the machine impacts upon the fraction of product contaminated. In general, for the Blow/Fill/Seal machine operating under a fixed set of machine conditions, there is a regular and definable relationship between the fraction of product contaminated and the level of airborne microorganisms. For a machine operating with the air shower off, the constancy of the behavior between Study 1 and Study 2 provides strong evidence that, under controlled conditions, Blow/Fill/Seal machine performance with respect to product contamination is highly consistent and reproducible. Overall, when the air shower is off, the relationship between product contamination and the spore challenge concentration has been comprehensively defined over a 50,000-fold range in spore challenge concentration. Moreover, the linear portion of the relationship is amenable to extrapolation providing a means for predicting air quality under which the frequency of product contamination is low and acceptable (see dashed line on Figure 7). For example, for the particular mode of machine operation employed here, a level of one organism per cubic meter of air is predicted to provide a rate of product contamination of  $2.3 \times 10^{-7}$  (i.e., one contaminated ampoule in  $\sim 4.3 \times 10^6$  ampoules produced).

Study 1 had previously shown that operation of an air shower around the filling mandrels reduced the probability of product contamination (3). In the present study, local protection was again seen to reduce the level of product contamination. For Study 2, however, maximal operation of the air shower was observed to bring about a 70-fold reduction in the level of product contamination for a given challenge concentration as represented by the common curve derived with the air shower off as opposed to approximately a 9-fold reduction for air shower operation in Study 1. The difference between the two studies in the extent of protection afforded by the air shower suggests that, for a given machine type, the configuration and arrangement of the air shower is critical to the efficiency of local protection. Nonetheless, the different curves derived for air shower operation in the two studies appeared regular and amenable to extrapolation (lower two dashed lines on Figure 8). They provided, at an average challenge concentration of one organism per cubic meter of air, predicted contamination rates

of around  $2.6 \times 10^{-8}$  and  $3.5 \times 10^{-9}$  for air shower operation in Study 1 and Study 2, respectively. It is worth noting that none of these predicted contamination rates for an average challenge of 1 spore per cubic meter of air, with or without air shower operation, could be assessed by any practical medium-fill study. Furthermore, the above findings provide clear evidence that microbial product contamination occurs during the filling element of the Blow/Fill/Seal process.

The observed increase in rate of product contamination consequent upon an increase in cycle time (both for air shower off and on at maximum) is indicative that the length of time taken by the mold carriage to move from the molding station (Parison head) to the filling station is a critical determinant of product contamination. Clearly, present data are limited and caution must be exercised in making definitive interpretations. Nonetheless, this behavior is in keeping with a second mode of product contamination occurring before the filling process (i.e., during container molding and/or transportation). It is also interesting to note the impact of changes in cycle time on the efficiency of local protection afforded by operation of an air shower around the filling mandrels. For the same air shower operating at maximum setting, a 70-fold reduction in product contamination was recorded at a cycle time of 12 seconds as opposed to about a 10-fold reduction at a 14-second cycle time. This behavior could be explained by hypothesizing that the element of product contamination which occurs prior to filling increases with increasing cycle time and, in so doing, reduces the apparent protection of the air shower operating around the filling mandrels.

Results of simulating gross interventions that compromise local protection of an air shower, achieved through switching the air shower off, have revealed that such interventions immediately impact the rate of product contamination. Resumption of operation of the air shower was also shown to immediately impact the level of product contamination. The rigor of the intervention, as controlled by the length of time when the air shower was not operated, also influenced the level of product contamination. Thus, for an intervention of 5-minutes duration, the fraction of ampoules contaminated was observed to achieve a maximum of 0.28, whereas, for the intervention of 15-minutes duration, a maximum of 0.48 was recorded. Furthermore, the minimum recovery time required to achieve pre-intervention levels was less than 1 minute following a 5-minute intervention as opposed to around 3 minutes following a 15-minute intervention. Clearly, both the establishment and the destruction of local protection afforded by the air shower are time functions. This behavior is in keeping with local protection, provided by filtered air emerging from the air shower, being achieved in part through establishing a compartment of 'clean' air within which critical Blow/Fill/Seal operations are conducted. However, further experimental work is required to provide conclusive proof for the existence of such a compartment. The constancy of the rate of product contamination for the production periods prior to, between, and after the two simulated interventions is also worthy of note. It provides further evidence that, under controlled conditions, Blow/Fill/Seal machine performance, in terms of microbiological quality of product, is highly reproducible and predictable.

It is essential to recognize that the findings described above, and their interpretation, apply only to the particular test machinery operated under the specified conditions. Nonetheless, they demonstrate the potential of employing 'medium-fill' under conditions of controlled microbial challenge to rationalize the performance of Blow/Fill/Seal technology in aseptic

processing. The findings reported here have shown that:

- a) The fraction of product contaminated is determined by the microbiological quality of the Blow/Fill/Seal machine environment.
- b) Under fixed operating conditions, the relationship between the fraction of product contaminated and the level of airborne microorganisms is regular, highly consistent, and reproducible.
- c) The protective shower of air around the filling mandrels reduces the frequency of product contamination; the efficiency of local protection is dependent upon air shower design and machine operating conditions.
- d) The time necessary for the mold carriage to move from the molding station to the filling station is a critical determinant of the rate of product contamination.
- e) 'Interventions' that compromise local protection afforded by the air shower have an immediate and detrimental impact upon the frequency of product contamination; however, the observed effects are fully reversible.

Our work also serves to demonstrate that responses to controlled microbial challenges can provide an effective approach to estimating rates of product contamination for advanced aseptic processing. Furthermore, they allow prediction of operating conditions, including machine operating conditions and environmental quality, under which an acceptably low frequency of product contamination is attained.

# Acknowledgements

The authors wish to thank the following companies for facilities and/or support in undertaking controlled microbial challenges of Blow/Fill/Seal machinery:

Automatic Liquid Packaging Inc., Illinois, U.S.A.

Fisons Pharmaceutical Division, Cheshire, England

Astra Pharmaceutical Production AB, Södertälje, Sweden

Invaluable technical assistance was provided by Mrs. Rita Taylor which is greatly appreciated.



# References

1. Barr DB. FDA'S Aseptic Processing: Proposed Regulation. *J Par Sci Tech* 1993;47(2):57-59.
2. Sharp JR. Manufacture of sterile pharmaceutical products using 'blow-fill-seal' technology. *Pharm J* 1987;239:106-108.
3. Bradley A, Probert SP, Sinclair CS, Tallentire A. Airborne Microbial Challenges of Blow/Fill/Seal Equipment: A Case Study. *J Par Sci Tech* 1991;45(4):187-192.
4. May KR. The Collison nebulizer: description, performance and application. *J Aerosol Sci* 1973;4:235-243.
5. Public Health Monograph No. 60. Sampling microbiological aerosols. U.S. Department of Health, Education and Welfare, Washington, 1964.
6. Dimmick RL. Stirred-Settling Aerosols and Stirred-Settling Aerosol Chambers. In: Dimmick RL, Ackers AB, eds. *An Introduction to Experimental Aerobiology*. New York: John Wiley and Sons; 1969; 127-163.



# Rigid Isolation Barriers: Decontamination with Steam and Steam Hydrogen Peroxide

Irving J. Pflug<sup>\*</sup>, Hans L. Melgaard<sup>\*\*</sup>, Craig A. Meadows<sup>\*</sup>, Jack P. Lysfjord<sup>\*\*\*</sup>, and Paul Haas<sup>\*\*</sup>

*University of Minnesota, U.S.A.<sup>\*</sup>, Despatch Industries, U.S.A.<sup>\*\*</sup>, TL Systems, U.S.A.<sup>\*\*\*</sup>*

# Introduction

In this manuscript, the concepts used in building a rigid barrier system for the aseptic assembly of pharmaceutical products are presented and discussed. In addition, some definitions and concepts which will help in the understanding of the development of filling lines in a rigid barrier isolator will be discussed.

In the U.S., as in Europe, the objective throughout the pharmaceutical manufacturing industry is to produce a product where the sterility assurance level (SAL) is less than  $10^{-6}$  (fewer than one unit in one million units is nonsterile). Since an SAL of  $10^{-6}$  cannot be proven by testing the product, a processing system must exist where the integrity that prevents microbial contamination is controlled in a positive manner. Only a process that has positive control of the critical points of contamination can be validated to produce an SAL of  $10^{-6}$ . This process must be validated similar to an autoclave sterilization process. It is only when a validated process is carried out according to the established protocol that the final product will have an SAL of  $10^{-6}$ .

The two very important words are *control* and *validation*. *We cannot validate a process where we do not have control of the process variables*. We must have a validation process to achieve an SAL of  $10^{-6}$ . Several terms and concepts in this area need to be defined prior to discussing barriers.

## *Containment versus Isolation*

It is only with an isolation system that the control necessary to even consider validating the system to an SAL of  $10^{-6}$  is achieved. In the aseptic assembly of pharmaceutical products in 1993, both containment systems and new small isolation systems exist. A containment type system uses a structure between the sterile area and the nonsterile person or element that will resist but, in general, will not prevent microorganisms from moving from the nonsterile person to the sterile product. We believe that there is general agreement in the industry that a cleanroom production facility that contains a person in protective clothing (in a bunny suit) cannot be validated in the way that an autoclave can be. To validate to an SAL of  $10^{-6}$  a true, positive barrier to limit the movement of contamination must be obtained.

An **Isolation System** is defined as a system having a positive barrier between the sterile area and the surrounding nonsterile area. It is necessary to distinguish between different kinds of isolation systems: **flexible barrier systems** are those systems that have flexible components (e.g., gloves, flexible isolators, half suits, and similar systems); **rigid barrier systems** are systems that have rigid walls where pressures can be produced and maintained that can be used as an input for an integrity control system.

The general goals for our barrier isolation system are to:

1. Protect the product from line operators by removing people from the open-vial filling area.
2. Protect the operators from the new, very toxic pharmaceutical products. It is necessary to have a barrier between the toxic product and the people.

3. Maintain an aseptic assembly environment through the use of HEPA<sup>1</sup> and ULPA<sup>2</sup> filtered air that will produce a probability of contamination of a product unit with an SAL of less than  $10^{-6}$ .
4. Reduce the overall costs of producing aseptically assembled products.
5. Design equipment systems that are flexible and user friendly.

# The Isolation Enclosure

A parenteral product filling line in an isolator is a system that is designed and constructed to ensure that the manufacturing and packaging operation will produce pharmaceutical products with a microbiological SAL of  $10^{-6}$ . The following three activities must be carried out successfully to achieve this.

1. Have a system that has the ability to transfer and deposit the product in the package and close the package so the SAL of the entire unit is  $10^{-6}$ .
2. Have an active, continuous control system in place such that if there is a problem it will first alert the operators and, second, will cause production to stop if critical control points necessary to produce or maintain an SAL  $< 10^{-6}$  fail or move out of specification.
3. Have an acceptable validation and certification program. Validation is the carrying out of a series of tests that substantiate that the specific process or activity will produce the required result. Certification is assembling the results and accumulated reports of the validation program in a package which is then reviewed and approved or signed off on by the responsible persons.

To produce an aseptically assembled product that has an SAL of  $10^{-6}$  in a system using barrier isolation technology (BIT) requires the following parts and inputs to the isolation enclosure (IE).

1. The product, as it arrives for packaging, must have a very low microbial load so that after packaging, the product unit SAL will be less than  $10^{-6}$
2. Packaging in Glass Vials
  - a. Glass vials will arrive at the IE from the discharge end of a continuous glass sterilization-depyrogenation unit.
  - b. Closures must have an SAL of  $< 10^{-6}$  when they enter the isolator.
  - c. A rigid isolation enclosure is a rigid unit of stainless steel, glass, and plastic with openings with doors for assembly and disassembly of equipment. The doors can be sealed so the isolation enclosure becomes a pressure vessel (low pressure). The inside of the enclosure is decontaminated or sterilized prior to start-up. The enclosure will remain sterile because it will be pressurized with HEPA- or ULPA-filtered input air.
3. Microbial Control and Validation of the IE
  - a. Prior to start-up, validate that through wipe-down, decontamination, and/or sterilization the microorganisms inside the barrier enclosure are killed to ensure that there is less than one viable microorganism per 10 square meters of surface at start-up and that there is a validated HEPA or ULPA filter system in place that will provide air to the IE with a very low viable particle count per cubic meter of air.
  - b. A validated control system that will alert operators and stop production if the IE integrity is breached during production.

- c. A validated particulate measurement-control system that will continuously sample the air at the container opening level. It will alert operators and halt production if the particulate count in the air at the filling nozzle/top of the open-vial level exceeds the established control point.

When the requirements listed above are examined, it can be seen that Nos. 1 & 2 are part of the pharmaceutical product manufacturing operation. For the purpose of this paper we will assume that these two items are taken care of since, at the present time, the general assumption is that adequately preserved product is entering the cleanroom manufacturing area and that glass containers, sterilized in a sterilization-depyrogenation tunnel, arrive at the isolator in a sterile condition. The closures will also be presterilized and, therefore, will arrive at the isolator in a sterile condition.

The remainder of this paper describes how requirement No. 3 is met with the barrier isolation system. For this discussion the items identified above have been grouped into the three major topic areas shown below:

1. The Isolation Enclosure
  - a. The rigid wall enclosure, jacketed doors, air seal product exit port, etc.
  - b. Validated HEPA- or ULPA-filtered air supply to maintain the IE under pressure.
2. A Validated Start-Up Sterilization Process — Steam at Atmospheric Pressure, or Steam at Atmospheric Pressure Plus Hydrogen Peroxide
3. Validated Measurement and Control System
  - a. Overpressure in the IE.
  - b. Particulates at the filling nozzle/top-of-vial level (assumption will be made that all particles are viable).

# Design of The Isolation Enclosure

The isolation enclosure has been designed as a practical, reliable processing facility. The walls of the IE are of stainless steel or glass; there are large doors so the filling line equipment can be easily cleaned and serviced. The doors seal tightly so the IE can be pressurized; there are glove ports so that machine adjustments and other control operations can be carried out by the operator outside the IE.

The barrier enclosure unit is constructed with an inner cavity, an upper chamber separated from the inner cavity by filters; an air return system; a means for supplying dry, heated air to heat the system; and a system for supplying a mixture of steam and hydrogen peroxide. The hydrogen peroxide under pressure is atomized into steam through an appropriate nozzle.

HEPA filters are located at the top of the IE so the air flow pattern is vertically down from the top to the bottom; the air returns in a 5-cm wide space at the side of the door panels. Doors are double-hinged so cleaning can occur on both sides of either panel and the glove ports are in the door so there is total access to the interior. A plan view of the IE with filling line in place is shown in Figure 1. A cross section of the IE is shown in Figure 2.

Despatch Industries has designed and constructed sterilization/depyrogenation (SD) tunnels that have the ability to sterilize the cooling zone (8). We envision the barrier isolator as an extension to the SD tunnel. The heating and cooling capability of the SD tunnel is used to supply heated or cooled HEPA filtered air to the barrier isolation enclosure. From an operational standpoint and commonality of utilities, the isolation enclosure and the SD tunnel are considered to be one large integral system as shown in Figure 3.

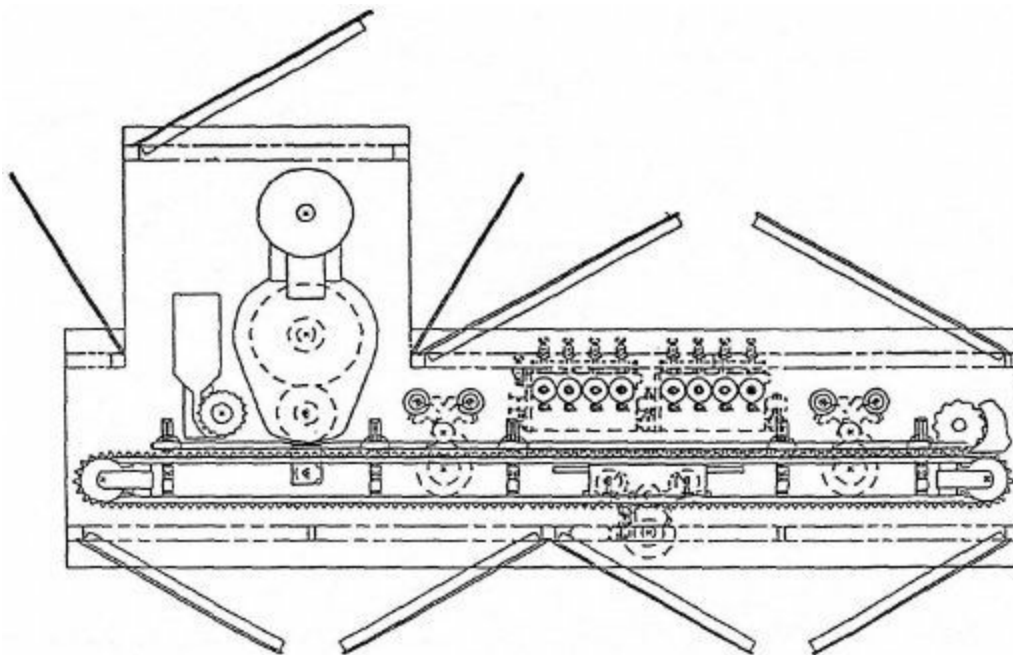

Figure 1. Top View of the Isolation Enclosure With a Filling and Stoppering Machine Inside



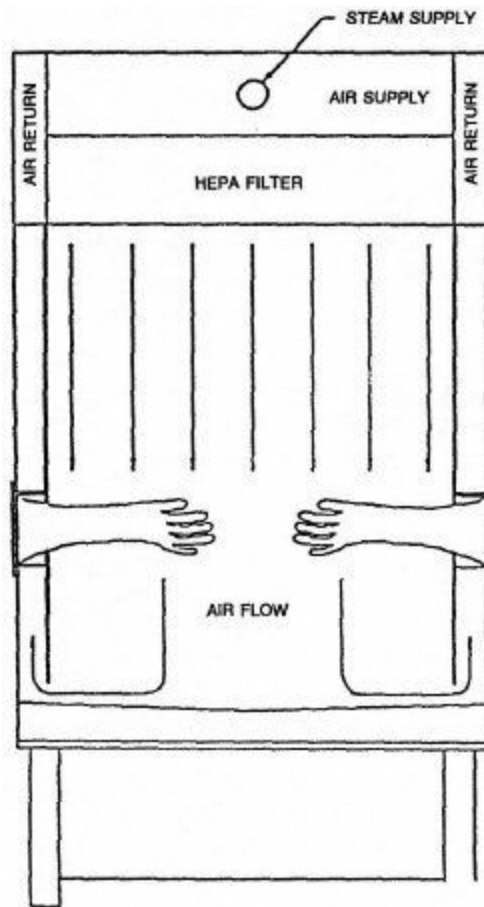

Figure 2. Cross-Section Through the Isolation Enclosure Showing the Air-Flow Pattern, the Location of the HEPA Filters, and the Gloves

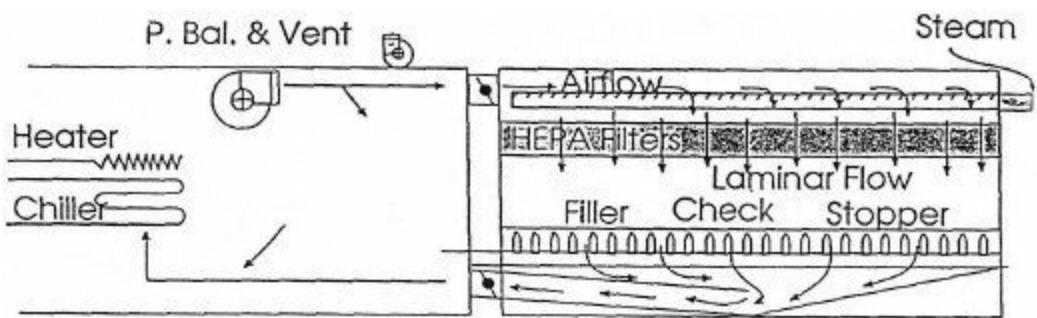

Figure 3. Isolation Enclosure Shown at the End of the Sterilization/Depyrogenation Tunnel With Emphasis on the Commonality of Utilities

*Comments on System Costs*

The economic impact of a barrier isolation system compared to conventional filling and stoppering in a cleanroom has been studied. A summary of the calculations showing the cost savings that can result when switching to a barrier isolation system in a Class 10,000 or Class 100,000 room versus conventional packaging in the traditional Class 100 cleanroom is shown in Table I. This analysis was performed for a 55-square-meter cleanroom. We did not take into account that a conventional Class 100 system will require elaborate change rooms or other

Single user license provided by AAMI. Further copying, networking, and distribution prohibited.

special facilities. In this analysis, the same area was used for all three rooms. The construction cost saving, over Class 100 costs, is \$385,000 for an IE system in a Class 10,000 and \$466,000 for a Class 100,000; the energy cost saving per year is \$132,000 for Class 10,000 and \$138,000 for a Class 100,000. The energy saving is quite significant for a filling line with a 20-year life.

**Table I. Construction and Annual Energy-Use Cost for a 55-Square-Meter Class 100, Class 10,000, and Class 100,000 Room**

<u>Classification of Facility</u>	<u>Dollar Cost, 1992</u>
<u>Construction Cost</u>	
Class 100	\$616,500
Class 10,000	\$231,000
<u>Class 100,000</u>	\$150,000
Construction Cost Earnings:	Class 100 vs. 10,000 = \$385,000 Class 100 vs. 100,000 = \$466,000
<u>Annual Energy Cost</u>	
Class 100	\$150,000
Class 10,000	\$ 18,000
<u>Class 100,000</u>	\$ 12,000
Annual Energy Savings:	Class 10,000 vs. 100 = \$132,000 Class 100,000 vs. 100 = \$138,000

# Start-Up Sterilization Process

In the first isolation barrier enclosure system, saturated steam at atmospheric pressure was used as the decontamination agent. When steam generated from water for injection (WFI) is used there are no chemicals; therefore, there are no chemical residues to deal with which is beneficial from both a people and drug product standpoint.

The test chamber used to evaluate different sterilization-decontamination processes is shown in Figure 4. Inside the test chamber, filling machine components such as pumps, mounting brackets, and a conveyor system were mounted. Thermal imaging was performed with a video camera to determine the coldest locations; thermocouples were installed in these areas as well as hooks to hang plachets for microbiological testing. A vertical longitudinal cross-section diagram of the test isolator enclosure indicating the location of the test plachets is shown in Figure 5.

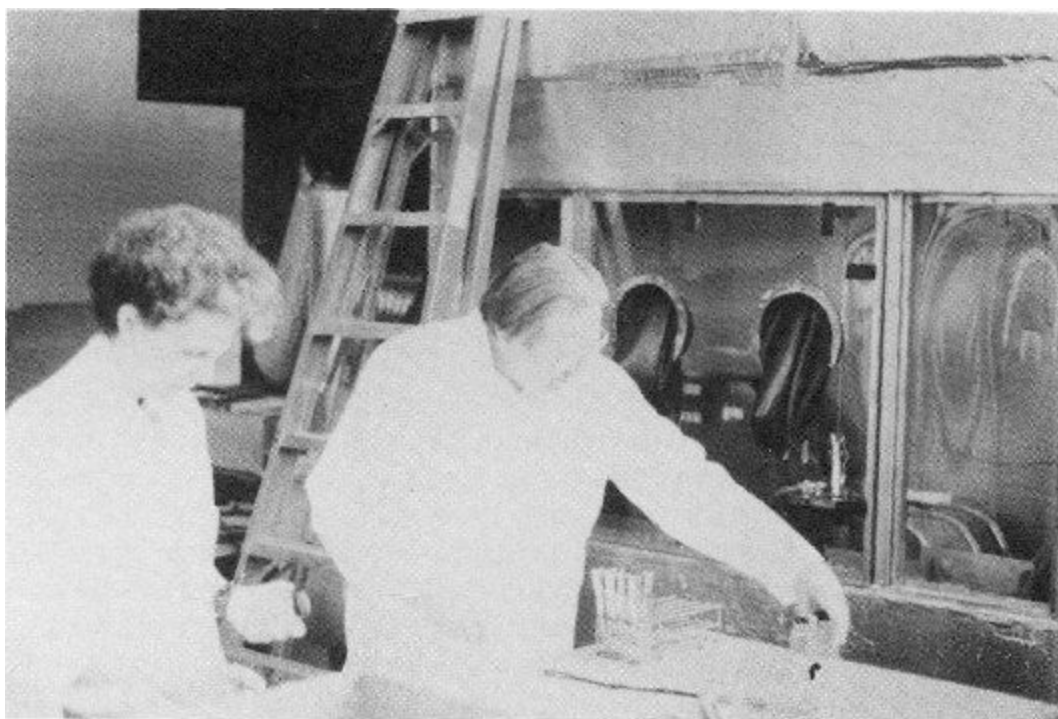

Figure 4. The Barrier Isolation Simulator which was Used to Perform Decontamination/Sterilization Studies

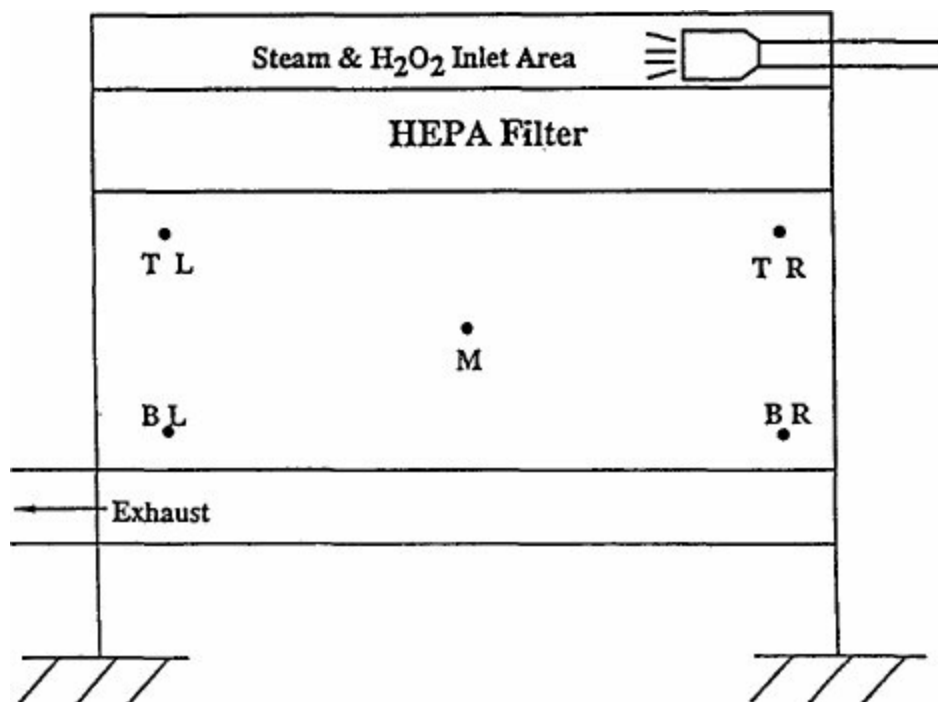

Figure 5. Vertical Longitudinal Cross-Section Through the Barrier Isolator Enclosure

Shown in this figure are the inlet for the steam or steam plus hydrogen peroxide, the HEPA filter bank, the location of the inoculated plachets used in evaluating the system, and the exhaust area

### *Evaluating the Microbial Kill Characteristics of Steam and Steam Plus Hydrogen Peroxide*

In designing the microbial destruction studies for steam or steam plus hydrogen peroxide ( $H_2O_2$ ), survivor data rather than endpoint data were gathered. Enumerating survivors entails considerably more work on a unit basis; the tradeoff, however, is that more information is obtained with fewer replicate units. Two replicate plachets were started at each location but were increased to three replicates in the middle of the study. When enumerating survivors, the spore log reduction can be estimated for each plachet and considerable information can be obtained about the process from only two or three plachets.

Stainless steel (SS) plachets, 1 inch wide and 2 inches long, cut from 0.020 inch thick SS shim stock with a 1/8-inch hole drilled near one end and each with an inscribed identification number, were used as the test spore carriers. Aliquots of a homogeneous culture of bacterial spores, deposited on the stainless steel plachets, were subjected to the steam or steam plus  $H_2O_2$  atmosphere for specific lengths of time. In the atmospheric steam studies, *Bacillus macerans* ATCC 8244 was used while *B. stearothermophilus* ATCC 7953 spores were primarily used in the steam plus  $H_2O_2$  tests.

The general procedures outlined in "Standard Methods for Examination of Space Hardware" (9) were used to recover the spores. The plachets were insonated in 50 mL of buffer solution in 100-mL bottles in an ultrasonic bath for 2 minutes. Following insonation, aliquots of the solution were serially diluted and duplicate plates, usually at two different dilution levels, were prepared. The pour plates, using appropriate agar for the specific spore crop, were incubated

for 48 hours. After incubation, the plates were counted with the aid of a Bactronic plat counter.

In our system at the lowest survival level, we plated, in duplicate, 1 mL from the 50-mL insonation solution. One microorganism on one of the two plates ( $2 \times 1.0$  mL) indicates a survival level of 25 spores per planchet. When both plates had zero counts, it was implied that fewer than one microorganism survived per 2.0 mL of the insonation solution, less than 25 spores per planchet. In this paper, "survivors per planchet" means the total number of organisms recovered in 2.0 mL of insonation solution.

### Saturated Steam

The microbial destruction characteristics of saturated steam are well known (1) and will not be discussed here. Our general procedure for saturated steam decontamination first involves wiping down the inside of the IE with a sporicidal followed by treatment with saturated steam. There are several stages to the steam decontamination process: hot air from the sterilization tunnel is circulated through the IE until the HEPA filter area is heated to about  $120^{\circ}\text{C}$ . At this time the filling line components in the IE are at approximately  $80^{\circ}\text{C}$ . When this has been achieved, the air system is shut down and steam in a super heated condition is introduced above the HEPA filters so that it will pass through HEPA filters in the gaseous state and then into the body of the IE. The high latent heat of the steam that condenses on surfaces immediately brings all the surfaces inside the IE to about  $100^{\circ}\text{C}$ . The steam process is continued for a specified length of time after which the steam is shut off and dry heated air is introduced through the HEPA filters to evaporate the condensed liquid. This is followed by cool air. The system generally cools rapidly; however, the heavier metal parts cool more slowly. The total time for the decontamination cycle, from start until filling operations can begin, is about 2 hours. A time-temperature graph is shown in Figure 6.

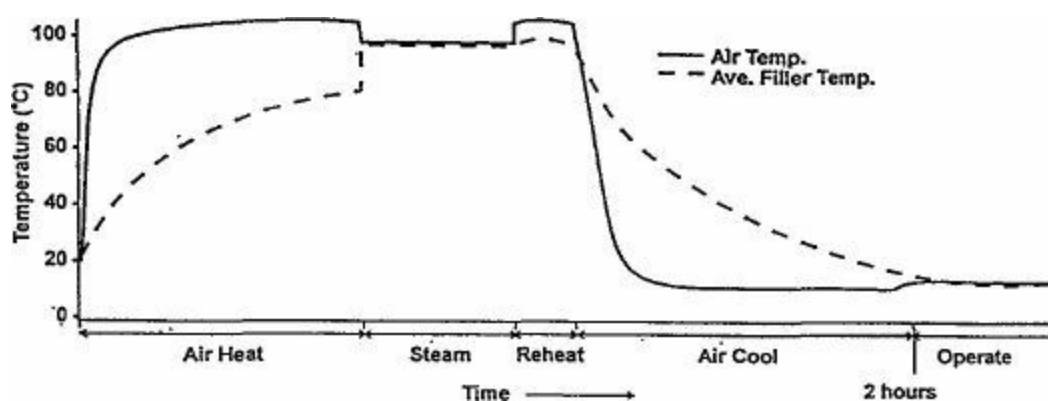

Figure 6. Temperature-Time Diagram for the Decontamination/Sterilization Cycle for the Isolation Enclosure

When saturated steam at atmospheric pressure was used alone as the decontaminating agent with a 34-minute steam process, we were able to effect a three log reduction in the number of *B. macerans* spores on stainless steel planchets located in that part of the barrier enclosure where spore survival was highest. Survivor data for the worst location are shown in Figure 7. Planchets that were contaminated with microorganisms from hands and other body surfaces were subjected to the steam decontamination treatment with the treated planchets

deposited in bottles of growth medium; all plachets tested were negative. The graph in Figure 8 shows the *B. macerans* kill and a general kill curve for vegetative microorganisms, fungi, and virus.

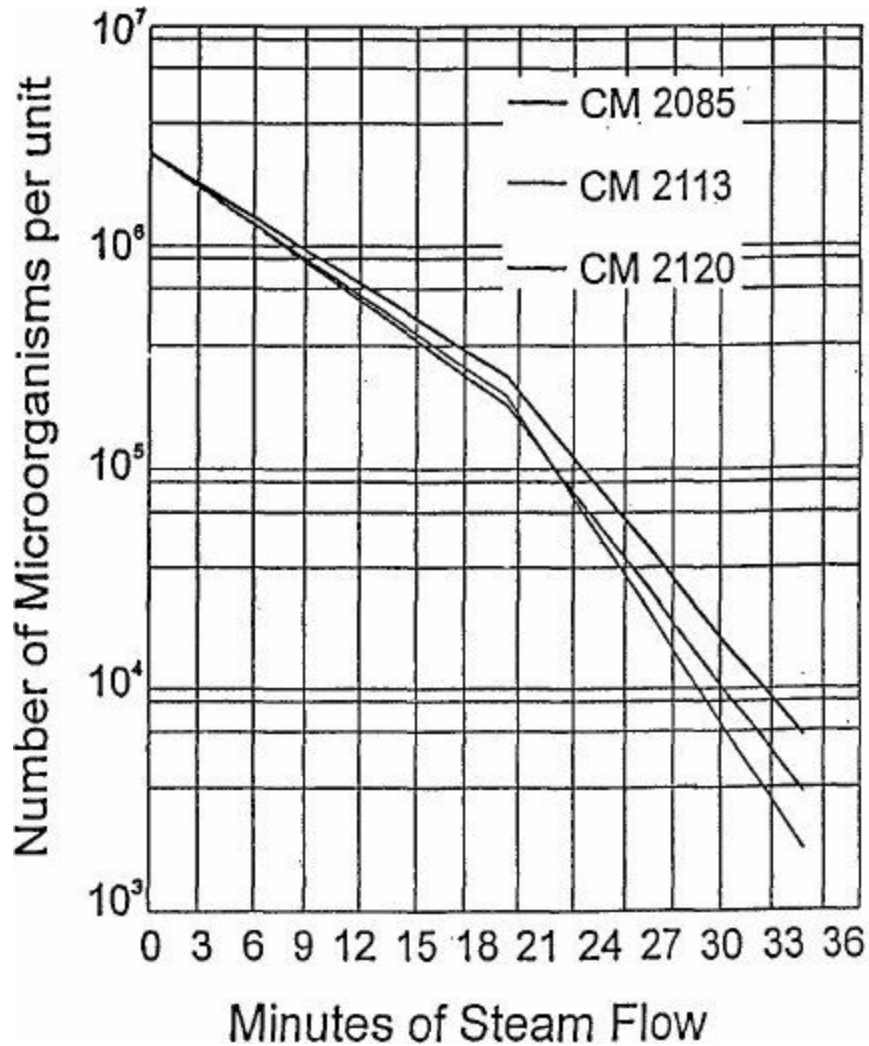

Figure 7. Survivor Curve Graph for *B. macerans* Spores on Stainless Steel Planchets Heated in Steam at Atmospheric Pressure; Three Replicate Experiments

Two heating times, 20 and 34 minutes, for each experiment. The data are for the location that had the highest number of survivors.

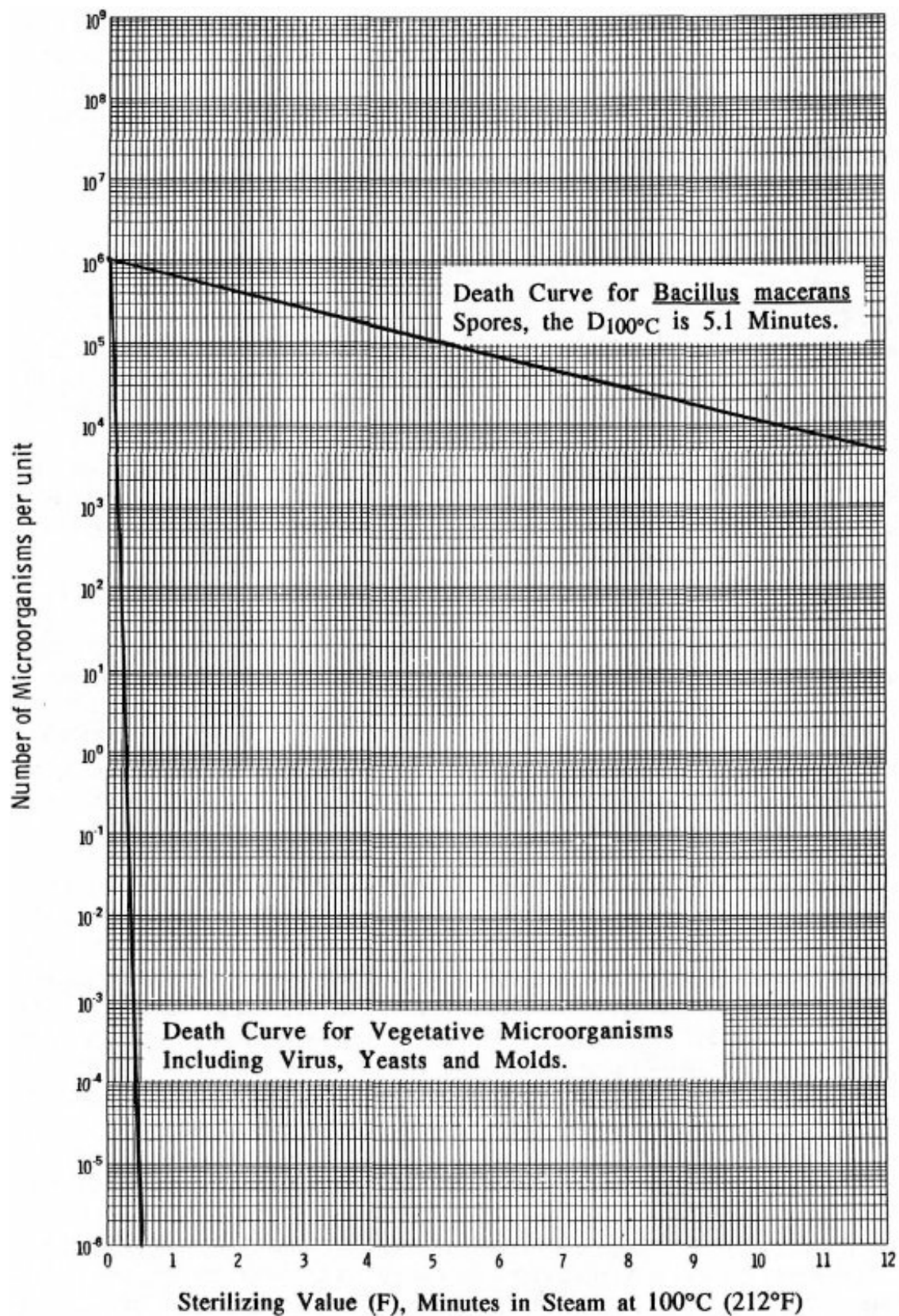

Figure 8. Relative Death Rate of the Validation Organism *B. macerans* and Vegetative Microorganisms

The process described above would result in a severe decontamination of the interior. The test performed with *B. macerans* indicates that the process would be very good at reducing the bioburden in an area where people were used to mount components. This process would not result in a sterile environment but in a sanitized environment.

## Hydrogen Peroxide

There is considerable literature on the use of hydrogen peroxide solutions for killing microorganisms (3,6,16). *Bacillus stearothermophilus* has been chosen as being representative of the most hydrogen peroxide resistant microorganism. Recent studies suggest that *B. stearothermophilus* spores are more resistant to H<sub>2</sub>O<sub>2</sub> than are *B. subtilis* spores. Rickloff (13) reported that *B. stearothermophilus* spores ATC 12980 were more resistant to H<sub>2</sub>O<sub>2</sub> in vapor form than *B. subtilis* var. *globigii* spores ATCC 9372. At 0.3 mg/liter at 7°C the D-values were 4.7 and 2.1 minutes and at 2.0 mg/liter at 35°C D-values were 0.3 and 0.2 minutes. Klapes and Vesley (5) found that *B. stearothermophilus* spores were more resistant to vaporized H<sub>2</sub>O<sub>2</sub> than *B. subtilis* var. *globigii*.

Rickloff and Orelski (14) evaluated 3.3 mg/liter of vaporized H<sub>2</sub>O<sub>2</sub> at 35°C and reported survival times at 2 minutes for *B. stearothermophilus* spores. However, of the five vegetative type bacteria, two fungi, and four sporeforming bacteria studied, only *Pseudomonas aeruginosa* on coupons and *Candida parapsilosis* in 5% bovine serum showed survival at 1 minute. The total kill for both of these organisms was at 1.5 minutes. Lewis and Rickloff (7) showed a fraction-negative/fraction-positive (FN/FP) graph of log D with hydrogen peroxide concentration (C<sub>H<sub>2</sub>O<sub>2</sub></sub>) for an AMSCO *B. stearothermophilus* suspension; the  $\Delta C_{H_2O_2}$  for a one log change measured from the graph was 1250 ppm. (Data are for the range 1.0 to about 2.9 mL/liter vaporized H<sub>2</sub>O<sub>2</sub>).

The potential users of IE equipment suggested that they should have the capability to sterilize the interior of the IE before start-up. Pflug, Larson, and Melgaard (11) conceived of the idea of adding H<sub>2</sub>O<sub>2</sub> to the saturated steam thereby making possible the sterilization of the IE using a short time process at atmospheric pressure. This process has a patent pending. We proceeded to design a H<sub>2</sub>O<sub>2</sub> feed and control system. The sequence of events of the steam plus H<sub>2</sub>O<sub>2</sub> process is similar to the saturated steam process and can be represented by the diagram in Figure 5 if H<sub>2</sub>O<sub>2</sub> is added to the steam. The total time for the steam plus H<sub>2</sub>O<sub>2</sub> isolator sterilization process is approximately 2 hours and is performed as follows. Hot air is introduced into the upper chamber and passed through the filters and into the isolator cavity before being returned to the hot air source through the air-return system. Once the filters are sufficiently heated so that no condensation will form on them when steam flow begins, air flow is stopped and saturated steam plus H<sub>2</sub>O<sub>2</sub> is allowed to flow into the upper chamber through a perforated conduit. The steam plus H<sub>2</sub>O<sub>2</sub> flows down through the filters, into the isolator enclosure, and out the exhaust. Since steam plus H<sub>2</sub>O<sub>2</sub> is less dense than air, it tends to stay at the top and displaces the air out the bottom of the enclosure as the steam plus H<sub>2</sub>O<sub>2</sub> is continuously added to the top of the isolator. The hydrogen peroxide process is approximately 10 to 20 minutes long depending on the microbiological load and the final SAL required. At the end of the timed H<sub>2</sub>O<sub>2</sub> addition the hydrogen peroxide is turned off although the steam remains on for a few minutes. This helps degrade the remaining hydrogen peroxide to water and oxygen before the start of the drying and cooling process. Cold, dry HEPA-filtered air is then added to cool the inside of the enclosure and its contents and to evaporate residual condensation.

A steam flow rate of about 0.6 kg/(min,m<sup>2</sup>) of enclosure cross-section area has yielded



acceptable results. Most of our microbial destruction-rate studies have been carried out at  $\text{H}_2\text{O}_2$  injection rates of 75 and 150 mL/(min,m<sup>2</sup>) for  $\text{H}_2\text{O}_2$  injection periods of 6 and 12 minutes. The quantity of 35%  $\text{H}_2\text{O}_2$  added was 450, 900, and 1800 mL/m<sup>2</sup>.

We initially evaluated the survival of *B. macerans*, *B. coagulans*, and *B. stearothermophilus* spores. There were no *B. macerans* survivors to a steam plus  $\text{H}_2\text{O}_2$  process of 450 mL/m<sup>2</sup> in 6 minutes; when the  $\text{H}_2\text{O}_2$  injection rate was increased to 900 mL/m<sup>2</sup> in 6 minutes, there were no *B. coagulans* survivors, but many *B. stearothermophilus* survivors. Extensive studies were carried out using *B. stearothermophilus* spores with  $\text{H}_2\text{O}_2$  rates of 900 mL/m<sup>2</sup> in 6 minutes and 1800 mL/m<sup>2</sup> in 12 minutes.

The results for 10 experiments where *B. stearothermophilus* spores were subjected to two steam plus  $\text{H}_2\text{O}_2$  treatments, 900 and 1800 mL, at two bottom locations, BL and BR, are shown in Table II. In these experiments, data were gathered at all five locations in the barrier isolator enclosure shown in Figure 5. The bottom locations, BL and BR, are the most distant from the inlet and therefore are the worst cases from two standpoints: a) the steam plus  $\text{H}_2\text{O}_2$  will have to displace all of the air from the enclosure before the lethal agent reaches these points and b) the  $\text{H}_2\text{O}_2$  degrades so the  $\text{H}_2\text{O}_2$  concentration in the steam will be less when the steam plus  $\text{H}_2\text{O}_2$  reaches the bottom of the enclosure than when it enters the top of the isolator. Only the data for the BL and BR locations are shown in Table II because almost all of the top location (TL and TR) plachets were negative. At the low injection rate, 900 mL  $\text{H}_2\text{O}_2$ /m<sup>2</sup> tests, 47 plachets were negative out of a total of 52 TL and TR plachets; at the high injection rate, 1800 mL  $\text{H}_2\text{O}_2$ /m<sup>2</sup>, 29 out of 30 plachets were negative.

The tests performed in Table II were conducted over a 3-month period using a commercial steam plus  $\text{H}_2\text{O}_2$  installation. There are many variables in the system. We were able to repeatedly obtain the same “essentially no survivors” result when 1800 mL of  $\text{H}_2\text{O}_2$ /m<sup>2</sup> was injected in 12 minutes and the same general number of survivors per plachet when 900 mL  $\text{H}_2\text{O}_2$ /m<sup>2</sup> was injected in 6 minutes. For the  $\text{H}_2\text{O}_2$  injection rate of 1800 mL/m<sup>2</sup> in 12 minutes there are data for 30 plachets; 26 were negative and four had colonies (counts were 2, 2, 12, and 25). A zero count indicates a 5.7 or larger spore log reduction ( $\log N_0 = 7.1$ ;  $\log 25 = 1.4$ ).

**Table II. Results of a Series of Tests Where *B. stearothermophilus* Spores PB27CT Deposited on Stainless-Steel Plachets Were Subjected to a Steam Hydrogen Peroxide ( $\text{H}_2\text{O}_2$ ) Atmosphere at an  $\text{H}_2\text{O}_2$  Inflow Rate of 150 mL/m<sup>2</sup> of Isolator Cross-Section Area for 6 and 12 Minutes**

In the Initial experiments, there were two replicate plachets at each location. Halfway through the project, we increased to three replicate plachets per location. (Empty boxes are conditions not tested.)

Test ID	Initial Number	900 ml H <sub>2</sub> O <sub>2</sub> /m <sup>2</sup> 150 ml H <sub>2</sub> O <sub>2</sub> /min m <sup>2</sup> for 6 min.						1800 ml H <sub>2</sub> O <sub>2</sub> /m <sup>2</sup> 150 ml H <sub>2</sub> O <sub>2</sub> /min m <sup>2</sup> for 12 min.					
		BL <sup>1</sup>			BR			BL			BR		
		P1 <sup>2</sup>	P2	P3	P1	P2	P3	P1	P2	P3	P1	P2	P3
CM2196	5.33E+6	1820	2850		5	453		0	0		0	0	
CM2204	6.00E+6	597	14340		0	0		0	0		0	0	
CM2211	4.92E+6							0	0		2	2	
CM2217	1.49E+7	323	359		0	0		0	0		0	0	
CM2225	1.45E+7	1507	2977		0	27		0	25		0	0	
IP2232 <sup>3</sup>	1.15E+6	0	0		0	0		0	0		0	0	
IP2240 <sup>4</sup>	1.54E+7	0	2251		0	0							
IP2245 <sup>4</sup>	1.39E+7	7152	11474	17860	280	3895	6885						
IP2253A <sup>5</sup>	1.27E+7	3	5	535	0	1	54	0	12	0	0	0	0
IP2253C	1.27E+7	1	1	19	1	20	304						
IP2260	1.34E+7	63	1911	5615	359	1089	1214						

- <sup>1</sup> Data are for the bottom of the barrier isolator enclosure. BL is the bottom left and BR is the bottom right. See Figure 5
- <sup>2</sup> P1, P2 and P3 are replicate plachets.
- <sup>3</sup> In Experiment IP2232, the N<sub>0</sub> was 1.15E+6, whereas in adjacent experiments, N<sub>0</sub> was one log higher.
- <sup>4</sup> In Experiments IP2240 and IP2245, the 900 ml of H<sub>2</sub>O<sub>2</sub> was delivered in 12 instead of 6 minutes.
- <sup>5</sup> In Experiment IP2253, the 6 minute experiment was repeated two times: A and C.

The tests at the 900 mL H<sub>2</sub>O<sub>2</sub>/m<sup>2</sup> in 6 minutes resulted in 21 out of 24 plachets with counts at BL and 14 out of 24 plachets at BR. These data indicate variation and are sensitive to the difference between locations BL and BR which did not show up in the 1800 mL H<sub>2</sub>O<sub>2</sub>/m<sup>2</sup> in 12-minute tests.

Variability in the results for the H<sub>2</sub>O<sub>2</sub> injection rate of 900 mL/m<sup>2</sup> in 6 minutes was observed which was expected because of the large number of variables in the system. The variability in microbiological results tends to be large whenever a chemical sterilant is used; consequently, we believe that the observed variability is well within acceptable limits. Pflug et al (12) report large standard deviations in their D-value studies.

Two additional comments: in experiment IP2232, the N<sub>0</sub> was about one log lower than in the adjacent test (log N<sub>0</sub> for IP2232 = 6.061) which probably led to zero colonies on all four plachets. The purpose of these experiments was to gather data on which to base a final sterilization process and not as a validation test. The effectiveness of steam plus hydrogen peroxide is clear in the results. The effect of the variables of H<sub>2</sub>O<sub>2</sub> level and action time are also apparent from this study. We clearly see the effect of 900 mL/m<sup>2</sup> in 6 minutes versus 1800 mL/m<sup>2</sup> in 12 minutes. The latter flow rate and time combination almost consistently produced

negative plachets; a small increase in either H<sub>2</sub>O<sub>2</sub> flow rate or action time would have produced all negative plachets. When designing the final isolator enclosure sterilization process, we can achieve whatever level of microbial kill is required by varying the H<sub>2</sub>O<sub>2</sub> injection rate and action time.

# Measurement and Control System

A positive control system over variables that can bring about the loss of integrity of the isolation enclosure is critical to the operation and, therefore, to the validation of a rigid isolation barrier system for an aseptic filling line. Two control systems are utilized in our system: a pressure balance system that will modulate the HEPA-filtered supply air to maintain the proper pressure in the isolation enclosure so nonsterile air cannot enter the isolation enclosure and a particulate measuring system at the filling nozzle/top-of-vial level.

## *Pressure Balance System to Maintain an Overpressure in the Isolation Enclosure*

The basic control problem is to balance the pressure between the sterile enclosure and the nonsterile ambient environment and across the product exit orifice. The control equipment must prevent excessive air flow from the enclosure to the tunnel which can result in a shifting of the hot zone profile and overheating of washer components at the entry end. The pressure balance system must ensure that the sterile enclosure pressure is always higher than the nonsterile side to prevent migration of air from the nonsterile to the sterile environment.

The simplest mechanisms available to accomplish pressure balance are manual dampers. Various combinations of electromechanical adjustable dampers are available for this application. The final system chosen was a solid state pressure transducer which is capable of monitoring the pressure differential between the high and low pressure areas, sterile and nonsterile side, with an accuracy of  $\pm 0.01$  inch water column gage (WC). This pressure control is set to maintain a constant differential (within the limits of the fans in the system). The fan capacity limits the upper bounds of the pressure differential that can be maintained.

The exhaust air volume calculation to maintain balance depends upon the cross-sectional open area at the end of the enclosure. From all standpoints, it is desirable to minimize the cross-sectional open area at the outlet of the sterile enclosure. Because of this, an automated profiling plate is incorporated. The automatic profiling plate has a home position which minimizes the cross-sectional open area when product containers are not passing out of the enclosure. When containers appear at the location immediately ahead of the profile plate, a photocell automatically initiates a shift in the profile plate position. The new profile plate position is selected by the operator based on the size of the container being filled. Calculation of the cross-sectional velocity required to maintain a specified pressure differential starts with the Bernoulli equation for steady state flow:

$$p = \left( \frac{V^2}{2g} \right) \left( \frac{\delta}{5.192} \right) = \left( \frac{V}{1096.7} \right)^2 \delta$$

where:

- p is the pressure in inches of water column
- V is the velocity in ft/min
- $\delta$  is the density in lb/ft<sup>3</sup>

$$V = 1096.77 \left( \frac{p}{2\delta} \right)^{0.5}$$

therefore,

$$V = 4 \times 10^3 (p)^{0.5}$$

$$Q = V \times A$$

Example: If the pressure difference across the wall of the sterile enclosure is:

0.12 inches WC and A is 0.25 ft<sup>2</sup>, then

$$V = 0.12^{0.5} \times 4 \times 10^3 = 1.38 \times 10^3 \text{ ft/min}$$

$$Q = 1.38 \times 10^3 \text{ ft/min} \times 0.25 \text{ ft}^2 = 346 \text{ ft}^3/\text{min}$$

This flow (Q) is with the profile plate in the normal raised position with containers present and approximates the gross airflow requirement to maintain the pressure differential between the sterile enclosure and the ambient environment.

The method of full automatic adjustment uses a solid state pressure transducer to measure the differential between the sterile enclosure and the nonsterile environment outside of the enclosure. A programmable logic controller (PLC) is used to calculate the average pressure differential between the high and low pressure sides. This mean value is used as the input to the Proportional, Integral, and Deviation (PID) action control loop. The control system will track the pressure in the sterile enclosure maintaining the sterile area at a constant differential above the pressure of the nonsterile ambient environment. The output goes to an alternating current (AC) variable frequency drive package. The pressure balance controller is set in hundredths of an inch water column, and the AC variable frequency drive controls the speed of the air supply fan. The fan has been provided with sufficient capacity to take care of brief periods of high air out-flow due to a reduced number of vials passing out under the profile plate or for other changes in the profile opening (Figure 9). The use of this system produced a documented reduction in reaction time and consistent pressure balance within  $\pm 5\%$  over time.

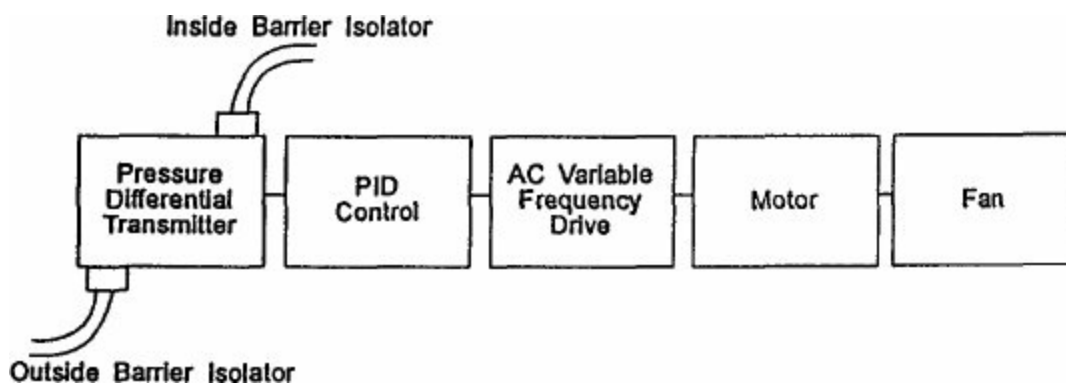

Figure 9. Pressure Balance Control System

### *Particle Measurement and Control*

In the operation of an aseptic filling line in a rigid isolation barrier, the surface microbial contamination at start-up will have been reduced to less than one per 10 m<sup>2</sup> of surface by the sterilization process and the isolation enclosure will be continuously pressurized by HEPA- or

ULPA-filtered air which will be under continuous control by a PLC. However, we propose to add an additional level of control consisting of a continuous air sampling system in which the air sample intake is at the filling nozzle/top-of-vial level. This will provide a continuous record of the quality of the atmosphere at this level in terms of particles. A laser type of particle counter will be used. An air sampling rate of 1 cubic foot per minute (CFM) is planned which monitors particles 0.5 micrometer in diameter and larger. (With this equipment, it is also possible to monitor at the 0.3 micrometer particle size.) The applicability of these measurements is indicated in Peck (10).

The output of the particle sampling system will feed into the PLC system and will be integrated into the overall computer control system of the isolation enclosure. In this way, the computer control system can be programmed to alert the operator if there is a change in the particle concentration in the direction of moving out of control and can stop the production line when the particle level is outside the control limits. From a microbiological contamination standpoint, we are interested only in viable particles. Since viable and nonviable particles cannot be distinguished, if we assume that all particles are viable, the control operation can be performed and there will be a safety factor because only a small fraction of the total particles will actually be or contain viable particles.

# Summary

An isolation enclosure, the start up decontamination or sterilization process, and the control system has been described which we believe will allow aseptic filling and capping of vials of pharmaceutical product in a simple and cost effective way with a product SAL of less than  $10^{-6}$ .

# Acknowledgements

Scientific Journal Services Paper No. 20867, Agricultural Experiment Station, St.-Paul, Minnesota 55108, on research conducted under Project 18-088, supported in part by Minnesota General Agricultural Research funds.



# References

1. Block SS. *Disinfection, Sterilization and Preservation*, 4th ed. Philadelphia PA: Lea and Febiger; 1991.
2. Bradley A, Probert SP, Sinclair CS, Tallentire A. Airborne microbial challenges of blow/fill/seal equipment: A case study. *J Par Sci Tech* 1991;45(4):187-192.
3. Curran HR, Evans RR, Leviton A. The sporicidal action of hydrogen peroxide and the use of crystalline catalase to dissipate residual peroxide. *J Bacteriol* 1940;40:423-434.
4. Federal Standard Clean Room & Work Station Requirements Controlled Environment. Fed Std 209C. October 1987.
5. Klapes N, Vesley D. Vapor-phase hydrogen peroxide as a surface decontaminant and sterilant. *Appl Environ Microbiol* 1989;56:503-506.
6. Leaper S. Comparison of the resistance to hydrogen peroxide of wet and dry spores of *Bacillus subtilis* SA22. *J Food Technol* 1984;19:695-702.
7. Lewis JS, Rickloff JR. Inactivation of *Bacillus stearothermophilus* spores using vaporized hydrogen peroxide. ASM Meeting, Dallas, Texas; 1991.
8. Melgaard HL. The historic and current status of dry heat sterilization and depyrogenation. ISPE Expo 89. (Unpublished report by Despatch Industries, Minneapolis, MN) 1989.
9. NASA. Standard procedures for the microbiological examination of space hardware. National Aeronautics and Space Administration Document No. NHB 5340.1A. Washington DC: Government Printing Office; October 1986.
10. Peck RD. What will the new federal standard 209C mean? *Pharmaceut Engineering* 1988;8(2):17-21.
11. Pflug IJ, Larson AB, Melgaard HL. Barrier isolation system. 1992. (US Patent Pending).
12. Pflug IJ, Melgaard HL, Schaffer SM, Lysfjord JP. The microbial kill characteristics of saturated steam at atmospheric pressure with 7500 and 2500 ppm hydrogen peroxide. (To be published in *J Par Sci Tech*, 1994).
13. Rickloff JR. The development of vapor phase hydrogen peroxide as a sterilization technology. HIMA Conference on Sterilization in the 1990s, Washington DC, October 30-November 1, 1988.
14. Rickloff JR, Orelski PA. Resistance of various microorganisms to vapor phase hydrogen peroxide in a prototype dental handpiece/general instrument sterilizer. 89th Annual Meeting of the ASM, New Orleans, LA, 1989.
15. Sinclair CS. Predictive sterility assurance for aseptic processing. Sixth International Kilmer Memorial Conference on the Sterilization of Medical Products, Brussels Belgium, June 13-15, 1993.
16. Toledo RT, Escher FE, Ayres JC. Sporicidal properties of hydrogen peroxide against food spoilage organisms. *Appl Microbiol* 1973;26:592-597.

---

## 1. HEPA (High Efficiency Particulate Air) Filter

An extended-media dry-type filter in a rigid frame having minimum particle-collection efficiency of 99.97% for 0.3 micrometer thermally-generated dioctylphthalate (DOP) particles or specified alternative aerosol, and a maximum clean filter pressure drop of 2.54 cm (1.0 in.) water gage, when tested at rated air-flow capacity.

## 2. ULPA (Ultra Low Penetration Air) Filter

An extended-media dry-type filter in a rigid frame having minimum particle-collection efficiency of 99.999% for particulate diameters  $>0.12\ \mu\text{m}$  in size.



# DISCUSSION

## Pharmaceutical Emerging Issues

## **Comment by Dr. Korczynski, Abbott Laboratories, U.S.A.:**

I have been responsible for developing sterilization processes for a number of years and have always been of the attitude that if you can terminally sterilize a product, do so. I have begun to realize, however, that with the increasingly complex formulations being developed in industry, we are merging into a truly new technology. The industry relative to aseptic processing had plateaued for a number of years, but we are now entering a new era and I am going to have to rethink my position on sterilization.

The pharmaceutical industry is currently involved in a technical evolution of its aseptic processing practices. In 1980 when a Pharmaceutical Manufacturers Association committee surveyed the industry on aseptic manufacturing practices, there appeared to be a wide disparity relative to the processing control practices.

At that time, a Parenteral Drug Association (PDA) monograph was issued that mentioned that about a 10% contamination rate was allowable for aseptic products. This was not stated as a requirement but rather as an anecdotal reference to WHO. There was a tremendous reaction at that point from many pharmaceutical companies who believed that this level may be unattainable. Industry is clearly beyond that attitude and position now. It is recognized that a 0.1% or less failure rate is indeed a standard for media fills and in some cases, companies are targeting for 0 out of 3000 fills. Through personal communication, I know that companies are making repetitive runs of 3000 fills, each with 0% failure rates. The latest ISO draft on aseptic processing is being issued internationally today. In this document, guidance is provided relative to media fills which ties the media fills to batch size and ties the acceptance/rejection level to the number of units that are filled during the media fill. A number of new approaches are being used, including removing human intervention, extensive training, form/fill/seal technology, and decontamination with hydrogen peroxide vapor. These approaches are all moving toward the area of aseptic processing improvement and I think taking us from a climate of aseptic filling to filling in an almost sterile environment.

As the industry moves forward to improve the quality of its aseptic filling operations, the FDA has and does express its interest that companies demonstrate, with actual data, that a product cannot be readily terminally sterilized. Seventy-seven domestic U.S. and international companies responded to a recent PDA survey. Roughly three-quarters of the companies said that 75% or more of their products are aseptically filled. The FDA estimated that it would only cost \$43 million for a total conversion. According to informal surveys, if 88 U.S. drug manufacturers changed one line to a terminal sterilization line, the cost without validation costs would be approximately \$280 million.

I think the question that has to be asked now is whether new improvement approaches to aseptic filling will reduce the need to consider product terminal sterilization. In addition, it must be asked whether aseptic processing will be viewed differently as it moves from its current status to a status involving an almost sterile environment.

## **Question for Dr. Enzinger, The Upjohn Company, U.S.A.:**

What method of aseptic processing has the capability of giving the highest level of sterility assurance for small volume injectables?

## **Answer by Dr. Enzinger:**

I would be hesitant to say that any specific direction is the right direction but we have to start with the filtration process. I feel that double filters are being used in series in order to improve the sterility assurance level of the filtration process itself. Design of the aseptic manufacturing process that accommodates moving sterile components into the filling line without the contamination of those components upon introduction into the filling line is essential. The removal of aseptic connections in the aseptic process is also essential since they offer a point of weakness where the product can be contaminated. With regards to the filling line, the most important thing that we can do in aseptic processing is to remove personnel from the filling line to prevent intervention within or on the filling line. The primary source of contamination during filling is due to personnel. Therefore, the design which best accommodates removal of personnel, whether it is a rigid barrier or the use of robotics, will most effectively increase the sterility assurance level on the line.

## **Question for Dr. Pflug, University of Minnesota, U.S.A.:**

During the sterilization cycle, was there a considerable amount of condensate in the isolator. Did you measure the hydrogen peroxide concentration in the condensate?



## **Answer by Dr. Pflug:**

The hydrogen peroxide in the condensate exiting the isolator was measured although it was usually below the level that could be measured, less than one hundred parts per million. It should be mentioned that we are operating at about 103°C and are degrading the hydrogen peroxide quite quickly.

## Question for Dr. Pflug:

Was catalase or any other agent used in the recovery media to neutralize the residual hydrogen peroxide?

## **Answer by Dr. Pflug:**

A buffer solution was used and some control tests were performed. No residual activity was found.

## Question for Dr. Pflug:

How much residual was in the isolator?

## **Answer by Dr. Pflug:**

In our general cycle in the isolator there is a hot air step both before and after the steam cycle; therefore, all of the hydrogen peroxide goes out with that.

## Question for Dr. Pflug:

Would it be more appropriate to continuously sample air for microbial control rather than particulate content at the filling point to adequately determine whether the microbial bioburden is sufficiently low?

## **Answer by Dr. Pflug:**

Control is necessary in the process. Continuous measurement of a variable is used so that if the particle count goes up for some reason the line can immediately be stopped. This can be used as a control function. I cannot think of a way to get an instant microbial result in order to achieve control.

## Question for Dr. Pflug:

Do you see a reduced environmental sampling program in these isolator systems? Generally, in a classical aseptic processing condition there is extensive daily shift basis of environmental sampling — surfaces and air. With the validation programs and systems that you have used, would you envision some reduction of that program?



## **Answer by Dr. Pflug:**

I cannot visualize the need for it. If the isolator is sterilized to begin with you already have a validated sterilization process. If you are using HEPA-filtered air which has a very low probability I do not believe there is a reason to have fallout plates.

## **Question for Dr. Sinclair, University of Manchester, U.K.:**

Please explain how your nebulizer system established that you had single spores in your aerosol system.

## Answer by Dr. Sinclair:

Let me first explain in theory what we would like to say happens. Our nebulizer produces a droplet size in the range of about 0.5 to 10 microns. In the water droplets from our spore suspension there is a probability that there will be one, two, three, or even four spores, depending on what concentration is used and on the conditions and certain features of the nebulizer. Provided that the humidity is right when the water droplets enter the room, the water evaporates almost instantly to leave the dried bacterial spore.

How is that measured? Our answer might be somewhat surprising. In our study, we actually measured the half-life of the aerosol under stirred-settling conditions. The half-life under these conditions is totally dependent upon particle size. We had the same half-life over the range of concentrations that we used. The half-life under stirred-settling is determined by particle size, by the height of the actual room, and you can actually look at tables and see what aerodynamic size of your particle is to give you that half-life. Aerodynamic size under stirred-settling conditions within our room was the size of a single bacterial spore.

## **Question for Dr. Kristensen, The Royal Danish School of Pharmacy, Denmark:**

Why has the European Pharmacopoeia chosen a value of 180°C for 30 minutes for dry heat sterilization, yet 160°C for 60 minutes is used?

## **Answer by Dr. Kristensen:**

The recommendations for dry heat sterilization in the European Pharmacopoeia are 180°C, 170°C, or 160°C for a specified time or at least 60 minutes at 160°C. I am unsure as to why 180°C is mentioned, other than that there might have been people who wanted it included in the Pharmacopoeia. I agree that 160°C is normally used.

## **Question for Dr. Enzinger:**

Dr. Sinclair's work indicated that the contamination rate of media fills done on blow/fill/seal machines is affected by changing machine operation conditions. Were the cumulated data from multiple-fill exercises and those reported by Sharp done with constant machine conditions?

## **Answer by Dr. Enzinger:**

The majority of data that we have accumulated in the last 15 years has in fact been done under constant machine conditions. We do, however, simulate the start-up of the process, which in my opinion is the roughest point in the process. Once you are through start-up, the process is more streamlined. We have recently started to look at various human intervention activities, such as monitoring coffee breaks and other types of interventions, to determine what the results would be on the media fills. Because we are dealing with such small number statistics, it is difficult to tell whether by monitoring interventions we are actually seeing a lower sterility assurance value than we did historically monitoring constant machine conditions.

## **Comment by Dr. Korczynski:**

There have been challenges to the concept that sequential media fills interrupted by time could be additive to project the total sterility assurance level. I think this is going to need to be discussed, because mathematically on a probability basis they cannot be added. However, conducting sequential studies must count for something when you consistently obtain zeros.



## **Comment by Dr. Enzinger:**

There is a controversy within the U.S. as to whether or not you can add the results of media fills to determine an average sterility assurance value. I have noted the criteria that a media fill must achieve in order to do the averaging.

## Question for Dr. Sinclair:

Was there a rationale for the numbers that were used in the microbial challenge on a per cubic meter basis? They looked rather rigorous.

## **Answer by Dr. Sinclair:**

Our rationale was to try and measure the fraction of product contaminants over as wide a range as practical. We would have liked to use a higher range, but there are experimental limitations associated with that; by using lower ranges, you eventually have to use an enormous quantity of product. You may recall the data which we had to run for 10 hours in order to achieve a measurable level of contamination at low concentrations.

## **Comment by Dr. Korczynski:**

On a cubic foot air basis, you were probably somewhere over 1,000-fold more rigorous than one would expect in a manufacturing protocol.

## Question for Dr. Sinclair:

What would be the predicted level of microbial contamination had HEPA-filtered air been used within the room?

## **Answer by Dr. Sinclair:**

We did not measure for that, although I was quite interested in Dr. Pflug's earlier comment suggesting that it would be exceedingly low in terms of microbial penetration through a HEPA filter. It would therefore be very hard to actually measure.

## Question by Dr. Enzinger to Dr. Sinclair:

There have been a number of guidelines with regard to control of cleanrooms in terms of microbial ambient airborne levels and they range from about .03 up to 1 organism per cubic meter. Using your extrapolations, approximately what sterility assurance level would that be if, for example, you used one organism per cubic meter or 1/10th organism per cubic meter? As I remember, it might put us down at a level of  $10^{-7}$  to  $10^{-9}$ .

## **Answer by Dr. Sinclair:**

You might actually be right but I would like to caution you that the work that we did was experimental. It was not done to show a new philosophy or a new approach. We have only looked at one organism type and I feel that there should be considerably more work done before we try to say what quality of environment would give what level of sterility assurance.



## **Comment by Dr. Enzinger:**

I think if we are successful in removing personnel from the cleanroom than the extrapolations that you are making will have a basis in realism.

## **Answer by Dr. Sinclair:**

I am sure you are right. But it really was a preliminary, fundamental, academic study where we tried to answer certain basic questions rather than the answer to everybody's question.

## **Question for Dr. Kristensen:**

Are there new developments as to the particular contaminant limits of containers? At least fill containers?

## **Answer by Dr. Kristensen:**

Yes, there are documents which will be issued by the Pharmacopoeia on large volume parenterals with methods and requirements for that type of product.

## Question for Dr. Kristensen:

You stated that the acceptability of  $10^{-6}$  sterility assurance level has not been questioned in Europe. Yet others have asked if there really is a need for  $10^{-6}$  SAL for aseptic filling processing. As I understood you, any product that passes the European Pharmacopoeia sterility test can be labelled sterile.

## Answer by Dr. Kristensen:

I indicated that we have not had any complaints or challenges to the  $10^{-6}$  sterility assurance level for sterilization of products which are normally heat sterilized by the pharmaceutical industry. We saw this afternoon that with some of the aseptic filling procedures, an SAL of  $10^{-5}$  or  $10^{-6}$  might be achieved. The  $10^{-6}$  level is related to sterile products in the Pharmacopoeia and is used by the industry in Europe.

There is currently a discussion in CEN as to what to call products that do not reach this level. I would prefer to find a term other than sterile for these products which do not meet the  $10^{-6}$  level but are acceptable and are approved for marketing by the authorities, although, it is true that we still have sterile products on the market that do not meet the  $10^{-6}$  sterility assurance level. As I tried to explain earlier, it's the old story of how the pharmacopoeia was written and how it came to be used.

**Session III**  
**Risks, Standards, and Methods**  
**Chairman: Marilyn N. Duncan**  
*U.K.*





# Opening Remarks

Marilyn N. Duncan

*Medical Devices Directorate, U.K.*

According to the Standard for Standards published by the British Standards Institution, one of the broad aims of writing standards is the “promotion of the quality of life: safety, health, and the protection of the environment”. This aim fits well into the theme of this Conference. Every day of our lives we are faced with risks. Risks which expose us to different degrees of vulnerability — from missing a plane and losing a contract, to twisting an ankle and being unable to take the dog for a walk. The probability of occurrence of the many and varied potential risks can range from the highly unlikely arsonist setting fire to all the papers in your office to setting off the smoke alarm by burning the toast — a very regular occurrence in my kitchen!

In this session we shall focus on risks in relation to safety. The internationally agreed upon definition of safety is “the freedom from unacceptable risks of personal harm”. We all know that no product or process can be made absolutely safe regardless of how much is spent on development and manufacturing.

How have we, and how should we, develop the limits in specifications, test methods, procedures, and standards to provide this “freedom from unacceptable risks”? How indeed do we know what is an “acceptable risk”? Four of the speakers in this session will be discussing aspects of safety limits in relation to sterility or the processing methods used to obtain sterility. Controversy has raged in this area for over 30 years. Many of my physicist and engineering colleagues get quite heated about what they see as the disproportionate effort which has been, and still is, put into the whole question of sterility assurance. They have pointed out that risks associated with sterility failure are no worse and probably much more easily dealt with than electrical, mechanical, or software failures where the results can be fatal or at least seriously damaging.

In his address, Dr. Wartenberg will draw upon an example from a similarly controversial area — that of exposure to toxic substances. As with sterility, the risk is a biological one and therein I suspect, lies the real problem. Potential mass exposure combined with fear of the unknown is an emotive mixture.

When engineers discuss risks and limits they refer to “single fault”, “double fault”, and “multiple fault” conditions and to “fail-safe mechanisms”. I am not an engineer but it is easy to understand that, provided there is the experience and knowledge to identify potential failures, it is possible to design and build in fail-safe mechanisms. Only then, in double or multiple fault conditions (which include the malfunction of the fail-safe mechanism) does a major risk appear. The probability that a double fault condition will occur in every piece of medical equipment at the same time is so remote that we can feel safe in the belief that while one or two people might be in danger, action will be taken to prevent recurrence long before the majority of users

are put at risk. Failing “safe” may, of course, also put a patient at risk from lack of continuous treatment, but I don’t want to enter the perilous field of discussing the virtues of good clinical practice in observing the patient versus reliance on alarm systems. It is sufficient to say that risks in the medical electrical or electronics area are primarily clear and solutions are available.

This may not be the case when dealing with mechanical failure, which is almost always a combination of design, materials, and processing problems. Again, however, the risks to patients or users are alleviated by the time factor; the frequency of use, method of use, and degree of stress needed to cause the first fault to appear all mitigate against multiple, instantaneous failures. This is well illustrated by the case of the Shiley heart valve where statisticians are constantly revising the risk factor as new cases are identified year by year. Implants are a special case where knowledge of the problem and the probability of failure does not eliminate the continuing risk to patients. Re-operation to replace the suspect device carries its own estimated level of risk associated with anaesthetic reaction, infection, and surgeon error. These could be described as unpredictable “biological” reactions in any specific case, but at least they are quantifiable across the types of surgical operation.

The biological risks associated with lack of sterility in medical devices have not, as far as I am aware, been quantified, and only in very specific cases where epidemiological evidence is available, have limits based on human data been set for toxicity.

In the case of sterile products we are dealing with bulk processing of products with varying levels of contamination and with microorganisms which may or may not be pathogenic and which will have varying resistance to the sterilization process. Given the worst case scenario of a total sterilization failure, we still have the unknown factors of whether the product will provide a growth medium, whether storage conditions will provide a “friendly” environment, and whether the recipient patient will be vulnerable to any pathogen which has survived and multiplied. The classic situation in which all of these probabilities are high is in the sterilization of intravenous fluids. In the U.K. many years ago, patients became very seriously ill and five died as a result of receiving contaminated solutions from a failed process. This has undoubtedly colored some of our thinking about sterility assurance levels. It did not lead us, however, to the almost universally accepted probability limit of one in one million ( $10^6$ ) for sterile devices. Indeed, the probability of contamination for a properly controlled heat sterilization process is more like one in  $10^{12}$ .

Probabilities were not used to establish heat sterilization parameters, however; rather, they were derived from the process. Sterility is an absolute and as such, its attainment cannot be tested. Thus, where new methods of sterilization were introduced, the sterilization parameters necessary to provide safe medical devices and exposure of individual patients to an acceptable risk had to be established. There was no way of equating the lethality of one system to another because the resistance of microorganisms varied between the processes. I don’t know what was in the minds of the eminent consultants who provided the original consensus, but I suspect it was a pragmatic decision based on the numbers of products and patients likely to be exposed to risk, worst case clinical situations, reproducible monitoring systems, and achievable processing standards. Their mistake, perhaps, was in allowing a target figure to become a set limit which people have since tried to verify scientifically.

Single user license provided by AAMI. Further copying, networking, and distribution prohibited.

Today, and in the future, speakers at Conferences and Standards meetings will justify

biological safety limits by mathematics. These arguments will either send you home satisfied or with gnawing doubts. Biological risks of the kind we are discussing at this Conference provide little in the way of irrefutable evidence and present an insoluble epidemiological conundrum. In these cases, I am happy to leave the solution to the consensus of the eminent and the wise.



# Risk Assessment: The Inexact Art of Hazard Evaluation

Daniel Wartenberg, Ph.D.

*UMDNJ — Robert Wood Johnson Medical School, U.S.A.*

The sight of abandoned chemical drums and the presence of chemical dumpsites have become all too commonplace across the U.S. While communities cry out for help in protecting their health and that of their children from these repositories, government regulators conduct complicated analyses to determine whether these sites pose an imminent hazard and what type of clean up action, if any, should be taken. Does living across the street from one of these sites increase the risk of developing cancer? Should residents be evacuated, as they were from Love Canal, New York and Times Beach, Missouri? Are the concerns of residents well-founded?

Trace levels of chemicals abound in our food and water supplies due to the application of pesticides and other crop treatments. Is there sufficient risk to children from eating apples that have been treated with Alar, a chemical growth regulator, that its use should have been banned? Do the myriad of pesticides found in the nation's ground water (often used for drinking) pose an unacceptable risk to public health?

The method by which we examine and evaluate these types of questions is Quantitative Risk Assessment (QRA). Simply put, QRA is a method used to forecast or predict risk, or assure safety. Conceptually, a risk assessor estimates the amount of a hazardous substance a person is exposed to, or dose, and multiplies it by the measured strength of the substance, or potency, to estimate that person's chances of developing cancer, or risk. This risk is typically expressed as the probability of developing cancer due to the exposure in question over 70 years, an entire lifetime.

In practice, the application of QRA is far more complicated and more problematic. Knowing what to measure and how to measure it accurately, i.e., to estimate dose, is in itself a difficult task. But even if the dose is known, we rarely have adequate human data concerning the strength of a toxic substance. Therefore, we base most QRAs on approximations of how much a person has been exposed to and on the fundamental assumption that strength, estimated from data on health effects detected in small populations of rodents exposed to high concentrations of the suspect chemical, can be extrapolated to predict health effects in large populations of humans exposed to lower concentrations of the same chemical.

Given these limitations some wonder why scientists do not directly measure the human health effects. The answer is that if they could, they would. QRA is used in situations where it is extremely difficult, if not impossible, to measure effects epidemiologically. One example is the evaluation of a proposed activity or facility. If it does not exist, the associated hazard cannot be measured. Another example is the consideration of extremely rare outcomes. It may be prohibitively expensive to develop the necessary system to collect adequate data to detect changes in rates of disease occurrence. Third, the population may be too complex to measure, i.e., there may be so many other risks to the members of the population that it is not possible

to separate out the effects of the particular exposure of concern.

In concept QRA is meant to be an objective approach to risk evaluation for making informed public policy. QRA is used to set priorities, e.g., in deciding which toxic chemical sites warrant attention first, and as a screening tool, e.g., to evaluate whether a proposed facility, even if operated under extraordinarily poor conditions, is sufficiently safe to be permitted. QRA can even be used to look at a hazardous process and determine which aspects of the process require alteration.

Although components of the QRA methodology allow for some flexibility, enabling risk assessors to accommodate a range of circumstances, many federal agencies have explicit guidelines for carrying out QRA (1). Thus, federal officials argue that there is little room for subjective judgments. In practice, however, even some Environmental Protection Agency (EPA) officials who are staunch supporters of QRA acknowledge its imprecision, noting that it entails a measure of subjective judgment. William Ruckelshaus, the EPA Administrator who championed the use of QRA with the agency acknowledged, "Risk assessment is like a captured spy. Torture it enough and it will say anything." (2)

# The QRA Process

To understand how QRA works, consider how the technique would be applied to the evaluation of cancer risks from the air emissions of a proposed municipal solid waste incinerator. Routine household trash is collected from a community, delivered to the incinerator, and burned under controlled conditions. Exhaust gases and particulates are passed through various filters and then emitted into the outside air. QRA can be used to evaluate the potential carcinogenic effects of breathing air that contains these emissions. (Although other aspects of incineration merit evaluation, including cancer risks from ash disposal and acute risks from other emissions, we explore here only risks from air emissions of carcinogens.)

Most federal agencies define QRA as a four-stage process. Although each stage is defined scientifically through guidance documents, risk assessors must also make some subjective judgments based on scientific interpretation and personal values. While some argue that these subjective decisions should reflect community values, in practice scientists conducting the QRA usually make these calls themselves, imposing their own best judgment.

## *Hazard Identification*

The goal of this first stage is to identify all situations or substances that, under any circumstances and irrespective of the amount present, might pose a risk to human health and to predict all possible adverse health effects that might arise from any combination of these. To assess incineration, a risk assessor compiles a list of materials that waft out of the smokestack: heavy metals such as cadmium, chromium, and nickel; organics like dioxin and polyaromatic hydrocarbons (PAHs); acid gases such as HCl and H<sub>2</sub>SO<sub>4</sub>; and criteria pollutants, such as lead and particulates. The potential adverse health effects of each of these substances is determined: cancers, nerve disorders, reproductive effects, and immune system dysfunctions.

At a later stage, unimportant substances or health effects can be excluded. However, omission of compounds or specific health effects from consideration at this stage can undermine the validity of a QRA.

The main controversy in this step is the omission of items that are fairly rare but become extremely dangerous. For instance, early risk assessments of incinerators ignored dioxins entirely because of the small concentrations. Subsequent studies indicated that, in some situations, they may have been responsible for the majority of the risk.

## *Exposure Assessment*

In this stage, for each of the substances listed in the above step, risk assessors estimate the amount a typical person is likely to encounter. To do so, the risk assessor must first determine the source and amount of the material at the facility in question—data that can be obtained from direct measurement, from historical records, or information gathered at other similar locations. For example, for proposed incinerators emissions data for extant facilities often are applied, after adjustment for the size and technical characteristics of the proposal under evaluation.

Single user license provided by AAMI. Further copying, networking, and distribution prohibited.

Next, with the help of complex computer models, the risk assessor tries to determine how

contaminants move through the environment and ultimately come into contact with people. This is usually done using complex material flow models, such as air dispersion models, that have been calibrated with some data specific to the site under evaluation, such as daily wind speeds and directions. For example, a risk assessor might model the settling of particulates onto agricultural fields, the uptake by plants and vegetables, the subsequent “bioconcentration” of these materials through farm animals which eat crops grown on these fields, and their path into human food. Translating this complex process necessarily involves some judgment calls. Early risk assessments of many incinerators failed to consider the settling of dioxin onto agricultural fields, even though this pathway can substantially contribute to total risk for the population.

But exposure assessment should not stop with modeling how people might come in contact with a contaminant. The risk assessor must estimate the actual exposure of a typical individual living nearby or working on site. For example, people living near an incinerator may breathe carcinogenic particles from plant emissions. While assessment of hazard based on these air concentrations may be relatively high, the individual’s risk from breathing the air may be mediated by the physics of inhalation. The largest particles in the air never reach the lungs because they are blocked by nasal hairs and tracheal mucosa, and many smaller particles enter and leave the lungs without depositing their toxic load.

Similarly, scientists have demonstrated that even if a suspect toxic is present in the environment it may not be in a chemical form that will lead to exposure. Studies of dioxin contaminated soil in New Jersey and Times Beach have shown that upon human contact with Times Beach soil, nearly all the dioxin was released while at the New Jersey site as much as 90% was chemically-bound in the soil and would not affect people (3). While this “bioavailability” is an important consideration in QRA, calculations must usually be made based on models rather than specific measurements for the facilities under consideration.

How does one define a “typical” person’s exposure to a contaminant? To be safe, risk assessors generally imagine what would happen under the most dire circumstances possible — the so-called worst-case scenario — such that if the risk in an unlikely situation is sufficiently small, the object of study must be safe under normal operating conditions.

Risk assessors often disagree about what kinds of worst-case scenarios should be considered and the criteria are subjective. In California, for example, a company applying to build an incinerator must detail in its proposal the potential consequences of a total failure of the facility’s air pollution control equipment: which materials would exit the stack, how long it would take to shut down the incinerator for repair, and what would be the likely effects on public health (4). Other states, however, dismiss such a technical failure as too unlikely to account for. Ironically, in one test burn at a new California facility, one of the baghouse filters failed during the testing phase showing that unlikely scenarios do occasionally occur even under the watchful eyes of the operators.

Risk assessors also disagree about how bad the worst-case scenario should be. Some apply what they refer to as a realistic worst-case — for example, a partial rather than total breakdown of equipment. The distinctions are important. The definition of worst-case, acknowledged by risk assessors to be subjective, to a large degree determines the severity of the final risk estimate.



Worst-case scenarios may also vary by definition of populations at risk. For example, when considering the risk of drinking milk from cows that graze on grass contaminated with small amounts of particulates deposited from incinerator emissions, some risk assessors use data on the average milk consumption for the entire U.S. population. Others may instead consider American adults who consume the greatest proportion of their diet as milk, a decision that would appear to be protective of public health. Some risk assessors, however, have shown that nursing infants may be at substantially greater risk than even adults who consume substantial amounts of milk products. They argue that worst-case scenarios must be modeled with infants rather than adults. Similarly, using average figures for vegetable consumption may fail to account for the effect of contaminants on strict vegetarians. Some risk assessors argue that worst-case scenarios must take into account these sensitive sub-populations.

### *Dose-Response Modeling*

The third stage of QRA is dose-response modeling — determining how much exposure to a given hazardous substance is harmful to public health. This varies according to the chemical's toxic strength "cancer potency."

In this stage risk assessors use laboratory animals as models for people. The merits of animal testing are controversial, particularly for the assessment of carcinogens. There are solid data for only a few carcinogens which compare the effects on animals with those on people. The effects are often similar. In certain cases, however, differences between human and laboratory animal sensitivity to the same chemical can be substantial (e.g., benzene), and use of animal data can lead to a great deal of inaccuracy when it comes to estimating risk. When the sensitivity to a substance varies among species of laboratory animal, the implications are even more confusing. Another problem is that animal data are typically based on tests in which only a few animals are exposed to extremely high concentrations of the chemical under study. This may preclude detection of chemicals that are weakly or moderately carcinogenic, but which may be extremely important if human exposure is widespread.

Critics of QRA who believe that the methodology is overly protective of public health argue that tests based on laboratory animal responses to high-dose exposures can overestimate the potency of some carcinogens and even designate materials that would be harmless at the concentrations to which people are usually subjected to as carcinogens.

There is also no consensus on an appropriate mathematical formulation for the dose-response model. Much dispute centers on the no-threshold model which maintains that exposure to even one molecule of a carcinogen increases the risk of getting cancer. Some investigators assert that the cellular damage caused by very low levels of exposure of certain chemicals can be repaired by other processes within the body. It has also been suggested that certain compounds mediate the effects of other substances so that people must be exposed to chemicals in a prescribed order for cancer to develop.

Conversely, other critics of QRA argue that substances can exacerbate the effects of other substances. If true, exposure to more than one substance could result in a substantially greater cancer risk than the sum of effects from exposure to each compound individually, so-called synergistic activity. The choice of model, again a necessarily subjective decision, will determine

the results of QRA.

For dioxins (emitted from incinerators or otherwise), the choice of the correct model has stirred a major controversy. When its potency was estimated mathematically from animal data on the basis of the no threshold model, dioxin seemed to be the most potent known carcinogen. The EPA, therefore, estimated that exposures of one part per billion increase the risk of cancer. When the potency of dioxin was estimated from mathematical models of biological processes, taking into account that it is carcinogenic only if it occupies certain receptor sites in the body, dioxin appears markedly less dangerous. It was the later estimate that led to Vernon Houk's conclusion that the Times Beach evacuation was unnecessary.

But the science seems to be more complex than even these models suggest: recently, far more sophisticated studies suggest that the effects of dioxin have no threshold and that relaxation of stringent exposure guidelines is not yet warranted (5). A thorough review of these results is underway.

In view of weak and contradictory human data, many environmentalists advocate retention of stringent standards as the most prudent strategy for protecting public health strategy. They also worry about the precedent of relaxing the standards for what was once touted as the most potent carcinogen known to man. Other scientists argue just as vehemently that existing regulations must give way to new data.

### *Risk Characterization*

In this final stage, the information from the three other stages is combined into an overall estimate of risk. For each chemical listed in the first stage, the assessor calculates in stage two a predicted cumulative worst-case exposure for a person over an entire average lifetime and multiplies this total exposure by the potency estimated in stage three to derive a predicted risk of cancer for an individual exposed to that amount of each chemical over a lifetime. For each chemical, the risk assessor then adds up these risks to get the total risk for the incinerator — or whatever activity is being evaluated. For an incinerator, most assessors add the risks of getting cancer from exposure to dioxins to the cancer risk of other organic compounds and heavy metals to get an overall risk for the incinerator — for example, one cancer death per million people exposed.

This approach has its pitfalls. Firstly, it assumes that when risks are combined, chemicals never exacerbate, reduce, or otherwise modify the effects of others. However, we know from studies of animals exposed to two pesticides that some chemicals increase the effects of each other, while other chemicals cancel each other out. Since there are little data concerning these types of interactions, EPA recommends that risk assessors simply add the risks. However, if that approach is wrong — and an assessor fails to account for even one large chemical interaction — results of the QRA would greatly miscalculate the risk.

# Improving Risk Assessment

The ability to subjectively interpret the different assumptions used throughout all the stages of the risk assessment process causes possible large variations in QRAs for the same situation or facility when conducted by different investigators. Some critics have illustrated the subjectivity of QRA by showing it is possible to use government guidelines and data for a particular QRA which result in numbers quite different from those presented by the government risk assessors. For example, in 1989 the Natural Resources Defense Council reassessed the risk of Alar, a crop treatment applied to apple trees. They calculated a risk of more than 2 cancers per 10,000 children, a value 25 times higher than EPA's most extreme calculation for the same situation. The different figures resulted from differing assumptions regarding exposure and potency. Paul Portnoy, an economist and Acting Director of the Center for Risk Management of Resources for the Future noted that, "the actual risk is several orders of magnitude below EPA's number...but there is also a chance that it could be higher." (6)

Given the controversy concerning QRA, a substantial effort has been made to improve its scientific underpinnings. In assessing exposure, a major focus has been on making more exhaustive, detailed measurements — sampling each person's exposure to a toxic substance, for instance, instead of making one estimate for an entire neighborhood. Biomarkers, complex biological compounds resulting from exposure, can indicate how much of a substance ends up in the body. To improve dose-response modeling, researchers are exploring the complex biochemistry of how the human body responds to specific compounds. Just as such studies have led to a debate about the potency of dioxin, the consideration of the ways other chemicals interact with human metabolic processes will result in reevaluation of the potency of other chemicals. Policy-makers, long preoccupied with cancer, are beginning to broaden the scope of risk assessments to consider other health effects from exposure to hazardous substances, including birth defects and neurological and immunological problems.

Some analysts are also advocating making the uncertainty and subjectivity of the risk assessment process explicit from the start (7). Some researchers argue that the limitations of the data employed in the assessment — such as the statistical parameters for measuring the exposure or the estimates of carcinogenic potency — should be quantified and made public, as should the assumptions and judgment calls a risk assessor makes throughout the risk assessment process. Just as critical, risk assessors should divulge the entire range of risk estimates that could have been obtained from the data if different assumptions had been made. Lastly, risk assessors should give their determination of the most likely estimate of the risk.

Changes are also being made in how the results of QRA are presented. It is becoming clear that presenting a single risk number — such as one cancer death per million people exposed — implies a degree of certainty unwarranted by the methodology. Instead, investigators are beginning to take into account the uncertainty of the numbers that go into their calculations and are presenting the QRA as a range of estimates. For example, in considering the risks of cancer from an incinerator, some assessors now offer separate QRAs for men, women, and children because each group has different physical characteristics, metabolisms, and exposures, and hence, different risks. Furthermore, risk assessors are evaluating eating habits, more

carefully allowing for the diets of a range of groups: vegetarians, people who fish and eat their own catches, and people who raise and eat their own vegetables. Each group of diners has a different exposure but all deserve to be protected from unnecessary risk.

# Translating QRA into Policy

Even more controversial than the figures that result from QRA is how they are used. All numbers are not viewed equally. These estimates often determine a government agency's position on the acceptability of an activity, such as the site of a solid waste incinerator. In some situations, such as consideration of hazardous waste sites, EPA has set a risk guideline — a lifetime cancer risk of less than 1 in 100,000. If a QRA estimates a lifetime cancer risk of less than this guideline, the activity is generally considered acceptable.

In other situations, such as the regulation of pesticides, EPA tries to balance the estimated health risk with the potential benefits of the activity, such as increased crop yield and decreased pest damage. Similarly, the Occupational Safety and Health Administration is mandated to consider factors other than the potential health effects of workplace exposure. Thus, factors other than risk may influence the regulatory process.

Public opinion — and the views of the regulated community — also play a role. An EPA report suggests that, “the remaining and emerging environmental risks considered most serious by the general public today are different from those considered most serious by the technical professionals charged with reducing environmental risk.” (8) For example, people find involuntary risks, such as cancer risk due to pollution from a factory, much more abhorrent than voluntary risks, such as cancer risk from smoking cigarettes. Moreover, people tend to find processes controlled by others, such as the site of an incinerator, more risky than actions under their own control, such as driving a car. Conversely, risks that are familiar, i.e., ones a worker encounters daily, seem less risky than unfamiliar ones, such as the introduction of a new process (9). There are many other considerations that QRAs cannot measure. For example, the impact of an environmental hazard on property values may be as important to some homeowners as public health concerns (10).

To resolve these issues risk managers must address the fundamental concerns of workers and community residents. Risk managers may also need to acknowledge that their views of the scientific underpinnings of their decisions are not necessarily the only “correct” views. A scientist will often respond differently when asked personally than when asked as expert about exposures of children to hazards at school or in the home, such as proximity to electric power lines. While acknowledging that there is currently insufficient evidence to warrant moving electric transmission lines away from public buildings and from homes, the scientist may be worried if his or her child attends a school or frequents a playground near or within a powerline right of way. These personal concerns must be considered in setting public policy.

However, even as scientists, individuals often disagree about the interpretation of data. A recent survey of members of the Society of Toxicologists concerning toxicological concepts, assumptions, and interpretations found profound differences of opinions, particularly about the ability to predict human health effects from animal data (11). This study indicated that differences in opinions among toxicologists were correlated with whether they worked in industry, academia, or government, suggesting that values may play a role not only in disagreements between scientists and the public, but also among scientists.

Another growing concern is the consideration of environmental equity or racial justice. Many people have noted that hazardous and undesirable facilities often end up in minority

communities and those of lower socioeconomic status (12). Some argue whether there were biases that led to the placement of these facilities in these neighborhoods while others contend that those with less financial resources chose to live in these less expensive regions. Again, issues of risk, values, and the appropriateness of remediation will figure prominently in the discussion of these problems.

# Defining Common Ground

The disparity between public concerns and those of scientists in regulatory agencies does not necessarily invalidate either and some regulators argue that both should be considered when establishing policy. Indeed, situations could be ranked on the basis of QRA, but decisions could also require explicit consideration of public priorities and offer alternative policy options. In far too many instances, however, the public is left out of the loop. Edicts from regulators routinely infuriate affected citizens who have not taken part in the evaluation. Declarations of scientific “truths” may also irritate scientists who do not interpret the data the same way as the scientists who took part in the evaluation.

The sense of disenfranchisement must be addressed head on. Local residents and workers should be considered vital sources of scientific information as their daily experiences confronting a hazard often provide more information than the best equipment science has to offer. For example, residents and workers often know the history and variability of contamination that scientists cannot easily reconstruct or measure. Residents also better understand the living patterns that expose people in a community to a hazardous substance. An epidemiological study in California was redesigned after residents explained an exposure pattern that state investigators had mischaracterized (13). For this guidance alone, local residents should be part of the QRA process from inception. Similarly, workers can provide vital pieces to solving scientific puzzles by providing researchers information about specific work practices and on-the-job exposures.

However, values vary from community to community and even within communities. Within specific workplaces, there may be many different responses to risk. Failure to consider this variation may invalidate a risk management decision in the eyes of those affected, irrespective of the quality of science employed in the QRA. Residents and workers must initially be included in the risk evaluation process in order for their concerns, fears, and desires to be articulated. Government agencies can no longer comfortably rely on pro-forma public hearings which perpetuate a “decide, announce, defend” strategy for dealing with environmental controversies.

Despite many government scientists and policy-makers who bristle at the notion of asking for input from the lay public, some government officials have gradually realized that imposing decisions on a resistant community is often fated to end in environmental gridlock (*sensu* Daggett, see 14) — if not overt conflict. There is grudging acceptance that just as weapons experts at the Pentagon are not the sole determinants of defense policy, neither should scientific experts be the sole determinants of environmental policy. Some agency scientists are growing weary of the risk wars and are looking for ways to forge truces. Although agencies have been slow to translate this realization into practice (15), there have been a few high-profile, and many quiet, experiments at peacemaking.

The science of risk assessment is commanding far more attention than the investigation of how to use QRA to forge truces rather than escalate battles. Uncertainties cannot be removed from the process of making a QRA, but they can be clearly defined. Subjective choices in QRA methodology cannot be eliminated, but they can be made consistent. Societal values, equity, and acceptability of risks cannot be viewed as uniform, but such variations can be

acknowledged. True progress in managing risks, however, can be made only if the people affected by the problem are made part of the solution which will take at least as much dedication as the scientific research.



# References

1. Environmental Protection Agency. Proposed guidelines for carcinogen risk assessment; request for comments. Fed Reg 1984;49(227):46293-46301.
2. Ruckelshaus W. cited in Wall Street Journal, January 3, 1985.
3. Umbreit TH, Hesse EJ, Gallo MA. Bioavailability of dioxin in soil for a 2,4,5-T manufacturing site. Science 1986;232:497-499.
4. Health Risk Assessment Guidelines for Non-Hazardous Waste Incinerators. August, 1990. State of California Air Resources Board.
5. Roberts L. More pieces in the dioxin puzzle. Science 1991;254:377.
6. Roberts L. Alar: The numbers game. Science 1989;243:1430.
7. Finkel AM. *Confronting Uncertainty in Risk Management: A Guide for Decision-Makers*. Washington DC: Center for Risk Management, Resources for the Future; 1990.
8. *Reducing Risk: Setting Priorities and Strategies for Environmental Protection*. Report of The Science Advisory Board: Relative Risk Reduction Strategies Committee to William K. Reilly. September 1990.
9. Slovic P, Fischhoff B, Lichtenstein S. Facts and fears: Understanding perceived risk. In: Schwing RC, Albers WA, Jr., eds. *Societal Risk Assessment: How Safe is Safe Enough?* New York: Plenum Press; 1980.
10. McClelland GH, Schulze WD, Hurd B. The effect of risk beliefs on property values: A case study of hazardous waste sites. Risk Analysis 1990;10:485-497.
11. Kraus N, Malmfors T, Slovic P. Intuitive toxicology: Expert and lay judgments of chemical risks. Risk Analysis 1992;12:215-231.
12. Bryant B, Mohai P, eds. *Race and the Incidence of Environmental Hazards: A Time for Discourse*. San Francisco: Westview Press.
13. Hance BJ, Chess C, Sandman PM. *Improving Dialogue with Communities: A Manual for Government*. Trenton, NJ: New Jersey Department of Environmental Protection; 1988.
14. Van Home CE. *Breaking the Environmental Gridlock*. New Brunswick, NJ: The Eagleton Institute of Politics, Rutgers University; 1988.
15. Chess C, Salomone K. Rhetoric and reality: Risk communication in government agencies. J Environ Education 1992;23:28-33.



# Patient Infections: The Relevance of Sterility Assurance Levels

Martin S. Favero, Ph.D.

*Centers for Disease Control and Prevention, U.S.A.*

# Introduction

In hospitals and other health care settings, it is commonly understood that medical devices, solutions, and certain other materials used for the treatment of patients must be sterile in order to prevent patient infections associated with these items. It is perceived, both by health care professionals and the medical device industry, that the sterilization process will ensure that any device or item labeled sterile will indeed be sterile and thus free from any risk of infection when used on a patient. The medical device industry's concept of sterility, however, differs from the concept employed in health care facilities which not only use devices delivered by industry in a sterile state, but also perform sterilization procedures themselves on medical devices, solutions, and items.

Over the years, the medical device industry has developed an operational definition of sterility that is referred to as a sterility assurance level (SAL). The SAL has evolved to a processing standard and contains the elements of good manufacturing practices (GMPs) as well as a quantitative measurement or estimate of the lethality associated with a specific sterilization procedure. The European Committee for Standardization has recently attempted to reconcile differences in interpretation of the word "sterile" as used in the U.S. and other parts of the world (10). A great deal of attention has been focused on the word "sterile" and the SAL required for different types of medical products and devices. In these deliberations, a certain amount of confusion has been created because of the failure to differentiate between the sterility of a given product and the SAL that is used by a particular industry to produce sterile products. This is further complicated by the assumption by some that products with different SALs present different infection risks for patients on whom they are used. This is clearly not the case. There has never been a relationship established between a particular SAL of a medical device and hospital-acquired infections.

This paper briefly reviews the concept of SALs, hospital-acquired infections associated with medical devices, and the differences in sterilization practices between industry and hospitals.

# Evolution of SALs

The first SAL was developed by the food industry to prevent botulism associated with improperly processed canned foods (2). For this purpose, large populations of *Clostridium botulinum* spores were prepared and studies on their moist heat inactivation rates at various times and temperatures were determined. These inactivation rates were used to calculate the D-value (time to kill 90%, or one logarithm, of the spore suspension at a specific temperature). Since it was virtually impossible, practically and scientifically, to establish an SAL by sampling cans of product after manufacture, a safety factor was established that incorporated the kinetics of *C. botulinum* spore kill so that the canned food processing cycle would have the equivalent of 12 D-values of spore kill. Given the estimated low occurrence of *C. botulinum* spores in food being processed, the SAL resulted in about a one in one hundred billion chance ( $1 \times 10^{-11}$ ).

During the early and middle part of this century the medical device industry relied on a totally different approach to the sterilization of devices and solutions (2). The U.S. Pharmacopeia (USP) described a finished product sterility test in which approximately 20 items of a batch of devices or solutions were assayed microbiologically to ensure sterility. As will be discussed later, this approach was not adequate because it could only detect an SAL of  $10^{-1}$  with 90% confidence when 20 items were sampled.

Activities of the National Aeronautics and Space Administration (NASA) in the mid-1960s significantly influenced SALs as applied to the medical device industry through its program in exobiology. In those years, one of the primary objectives of the U.S. Space Program was to explore life on planets of biologic interest. NASA decided that spacecraft destined to land on the planet Mars should be sterilized. Subsequently, the agency specified that the probability of landing a contaminated spacecraft on Mars would be  $10^{-4}$  per mission. Dry heat was selected as the sterilization method, which meant that spacecraft components had to be compatible with dry heat sterilization cycles. This sterilization program was ultimately successful and resulted in the development and validation of a sterilization protocol that included good manufacturing practices, the correlation of a known microbiologic load to a sterilization procedure designed to reach a specific end-point, and incorporation of sterilization cycle lethality into the overall process (2).

During the 1970s, the U.S. Food and Drug Administration incorporated these concepts into its policy and industry adopted the concept of SALs in producing sterile products (2,10). Figure 1 shows a hypothetical inactivation curve for a population of microorganisms exposed to a sterilizing agent — heat, gas, or radiation. The SAL can vary depending on the time of exposure.

In the 1960s, the Swedish public health authorities required a stated SAL of at least  $10^{-6}$  for medical devices that were labeled sterile (8). An SAL of  $10^{-6}$  has subsequently been used throughout the world and with a variety of sterilization processes, including heat, ethylene oxide gas, and ionizing radiation. In 1979, the Canadian Health Protection Branch proposed two SALs based on the end use or product tolerance (2). SALs of  $10^{-3}$  and  $10^{-6}$  were proposed but never implemented because of anticipated marketing battles over implied benefit to the patient depending on the specific SAL. Dual SALs have been used in the U.S. for many years (Tables I, II, and III). The choice of a  $10^{-6}$  SAL was strictly arbitrary and has never been correlated

with any adverse outcomes, such as patient infections.

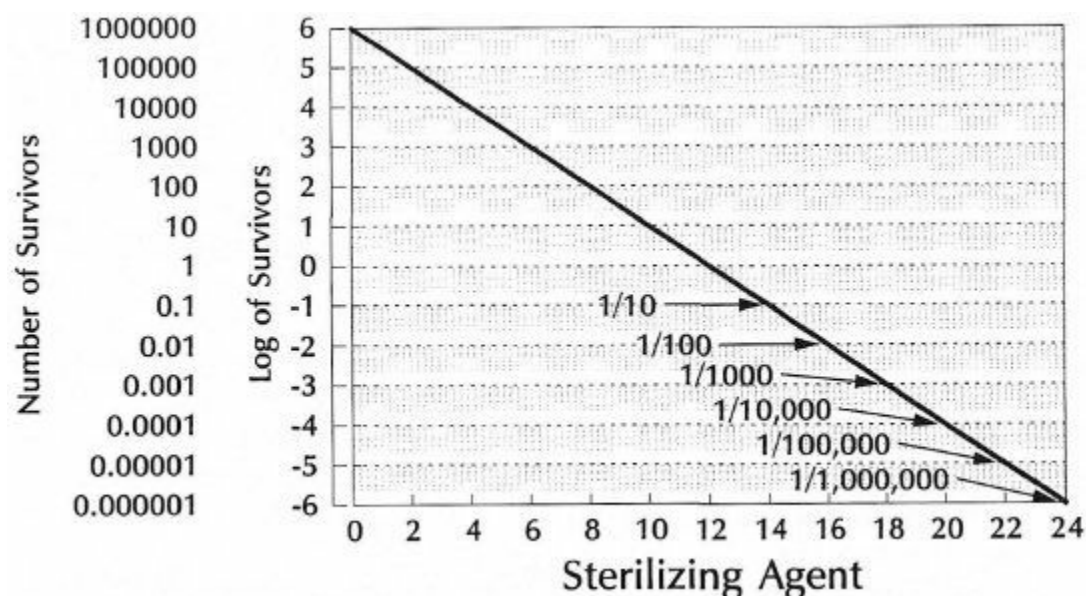

Figure 1. Sterility Assurance Levels

**Table I. Medical Products at Various SALs**

Products Typically Processed at  $10^{-3}$  SAL

- ECG Electrodes
- Drainage Bags
- Blood Collection Tubes
- Culture Media Devices
- Grounding Pads
- Labware
- Specimen Containers
- Serological Pipets

**Table II. Medical Devices at Various SALs**

Products Typically Processed at  $10^{-3}$  and  $10^{-6}$  SAL

- Surgeons Gowns and Drapes
- Catheters
- Marking Pens
- Surgeons Gloves
- IV Sets
- Drainage Bags

**Table III. Medical Products at Various SALs**

Products Typically Processed at  $10^{-6}$  SAL

- Laparotomy Sponges
- Cauterizing Devices

Based on the data in Figure 1, there is always a finite probability that a microorganism may survive regardless of the intensity of the sterilization process. It is emphasized that an SAL is a probability factor that is the theoretical result of a sterilization procedure and should not be construed as equivalent to the definition of sterility. SALs used by industry for the production of sterile products include sterilization process reliability; sterilization cycle development; calibration of equipment; validation of the entire sterilization process; standard loads with known zones of minimum lethality; computerized processed monitoring; and control, product, and process change control and good manufacturing practices, such as control of microbial contamination on products prior to the sterilization procedure.

Implicit in an SAL is not just the concept of sterility and the probability of an item being contaminated, but all the elements of GMPs and process validation. The SAL is a minimum based on all process variables and is the result of a most conservative calculation. In short, the SAL is a measurement or estimate of lethality of the entire sterilization process.

# The Relationship of SALs to Hospital-Acquired Infections

Factors associated with hospital-acquired infections have been studied for many years and there is overwhelming evidence that microorganisms associated with these types of infections originate from patients as part of their own microbiologic flora, from visitors, from health care personnel, or in some instances, the environment. Jarvis et al recently reported that the Hospital Infections Program of the Centers for Disease Control and Prevention (CDC) conducted 125 on-site epidemiologic investigations of hospital-acquired outbreaks from 1980 to 1990 (7). Eleven percent of these outbreaks were related to medical devices; 13% to medical procedures; and 22% to specific products. None were associated with products or medical devices originating from industry and labeled sterile. Further, the author is unaware of any instance of an outbreak of hospital-acquired infections associated with devices originating from industry and labeled sterile. However, there have been instances of inadequately processed intravenous solutions which allowed for the growth of microorganisms and subsequent infection of patients (9).

In contrast, medical devices sterilized by hospitals and other health care institutions such as hemodialysis centers may have problems because of mistakes made during the sterilization process. For example, in the U.S., approximately 70% of all licensed hemodialysis centers reuse hemodialyzers on the same patient (4). The hemodialyzer originates from the manufacturer and is labeled sterile with an SAL of  $10^{-6}$ . The dialyzer after being used for patient treatment is cleaned and packed with a chemical germicide which is left in the dialyzer for approximately 48 hours. The germicide is then rinsed out and the dialyzer is used again. A set of standards published by the Association for the Advancement of Medical Instrumentation specifies the manner in which the dialyzers should be processed and a number of tests that deal with the functionality of the dialyzer (12). After being processed as specified, the dialyzers are designated as “sterile”; however, the process leading to that designation bears very little resemblance to the one used by the original manufacturer to achieve an SAL of  $10^{-6}$ . At the very most, under ideal conditions, a dialysis center reprocessing program is not able to achieve more than a  $10^{-3}$  SAL and, in many instances, the process could not be called sterilization but rather high-level disinfection. Furthermore, the process is subject to user error either in the process itself or in the dilution of germicide. In addition, rinse water may contain high levels of bacterial contaminants. All of these may cause bloodstream infections and/or pyrogenic reactions. CDC has investigated approximately 13 outbreaks of infections or pyrogenic reactions associated with the reuse of dialyzers (Figure 2). All of these outbreaks were related to user errors.



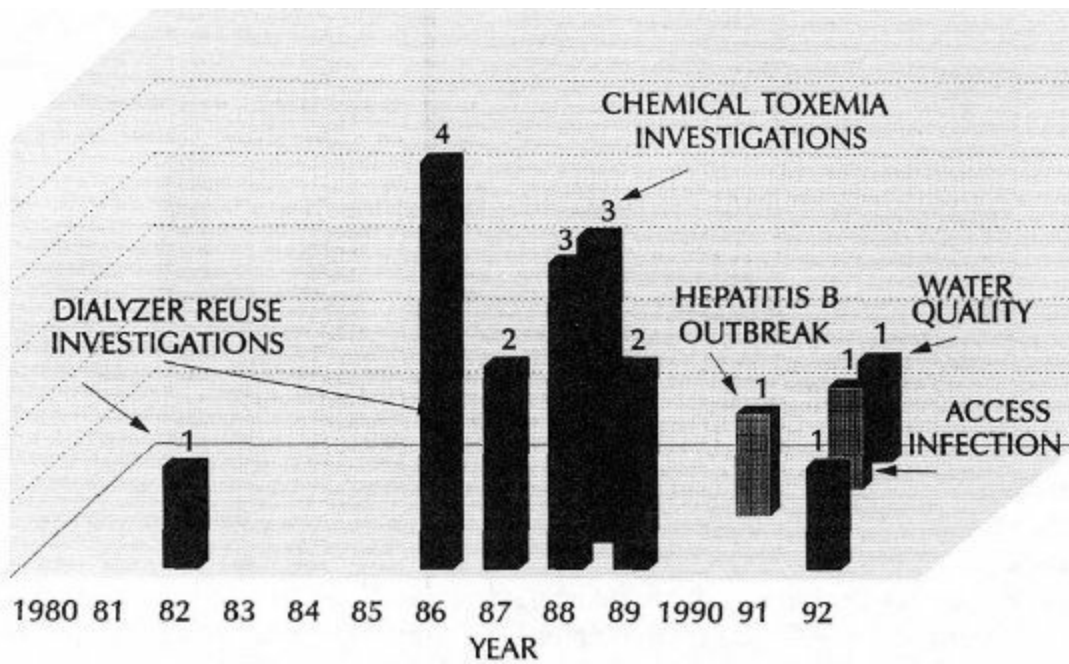

Figure 2. Investigations of Dialysis-Associated Outbreaks by the Centers for Disease Control

There are other devices, such as flexible fiberoptic endoscopes, that many infection control practitioners suggest should be cleaned and sterilized. However, it is virtually a universal practice in the U.S. that these devices, in spite of the fact that they may enter sterile areas of the body, are not sterilized but rather cleaned and subjected to a process of high-level disinfection (3). A further complication is the fact that many of these devices are constructed such that it is very difficult to properly clean them prior to a disinfection step. The result is the use of a device with an SAL that may range from  $10^0$  to  $10^{-3}$ .

In Table IV, various devices are listed along with their estimated SALs when originating from industry or from being processed in a health care facility. In the health care facility, some sterilization procedures are significantly affected by the manner in which protocols are implemented. If the protocols are performed in a rigorous manner, it is unlikely that patient infections will be associated with the use of the device. If errors are made in the performance of the protocol or with the concentration or type of sterilant, the devices can remain or become contaminated and result in patient infections. Steam and ethylene oxide sterilization systems, because of the automated aspects of their operation, are much less prone to failure than sterilization or disinfection procedures using liquid chemical germicides.

**Table IV. Comparison of Sterility Assurance Levels Industry vs. Health Care Facility**

Device	Estimated SAL	
	Industry	Health Care Facility
Hemodialyzer	$10^{-6}$	$10^0-10^{-3}$
Endoscope	NA	$10^0-10^{-3}$
Laparoscope	NA	$10^0-10^{-3}$
Implant	$10^{-6}$	$10^{-6}$
Inhalation Therapy Tubing	$10^{-6}$	$10^0-10^{-3}$

Single user license provided by AAMI. Further copying, networking, and distribution prohibited.

These examples show that disinfection or sterilization procedures performed in health care settings are often subject to user errors that may result in patient infections. These procedures are significantly different from those used in industry to produce devices that are labeled sterile (5).

Factors responsible for hospital-acquired infections include the underlying illness of the patient, host defense, the type of medical devices and the manner in which they are used, and quality of care (1,11). For example, the likelihood of bloodstream infections occurring in patients as a result of having a central line is much higher among burn patients, pediatric patients, and coronary medical and surgical patients than among respiratory and neurosurgical patients (7). These central lines are obtained from the manufacturer in a sterile state with an SAL of  $10^{-6}$ . The SAL, whether it was  $10^{-6}$  or  $10^{-3}$ , would virtually have no bearing on hospital-acquired infections associated with the use of this device.

In Tables II, III, and IV, various medical devices are listed that have varying SALs. The manufacturing process leading to the SALs, whether they be  $10^{-3}$  or  $10^{-6}$ , results in a product that at its point of use would not be expected to have any microorganisms present that could cause an infection in a hospitalized patient.

Once a medical device with an SAL of  $10^{-6}$  is removed from its packaging and used on a patient, it no longer retains the theoretical SAL of  $10^{-6}$ . In fact, if the device is left out in an area such as a surgical suite and exposed to the air, the device will quickly become contaminated with microorganisms in the sense that if a sterility test is performed at that time, the test would be positive. This situation is not associated with surgical wound infections by using such a device. Therefore, in many instances, the SAL at the point of use is very different from the theoretical SAL associated with the medical device and its manufacture.

# Discussion

There has been much discussion and debate among the industrial sterilization communities of the U.S. and the European Economic Community regarding SALs and their meaning. There are proponents of a single SAL of  $10^{-6}$  for all devices that are labeled sterile; similarly, there are proponents of the idea that an SAL, which historically has been arbitrarily selected and without any basis in hospital-acquired infection sciences, could be flexible. Flexibility is an advantage because some materials may have problems with longer cycles or radiation doses. There may also be environmental impacts associated with chemical residues as the result of certain types of sterilization cycles (9). And finally, there are issues of cost. Obviously with some sterilization cycles, the cost is significantly higher to produce a medical device with an SAL of  $10^{-6}$  as compared with one that has an SAL of  $10^{-3}$ . Since there is literally no evidence that there is any risk to patients for infections or any other adverse events associated with medical devices that have SALs of  $10^{-6}$  compared with those that have SALs of  $10^{-3}$ , the considerations of materials compatibility, environmental constraints, and cost are quite legitimate factors that may lead a particular industry to adjust the SAL. The arbitrary establishment of a single, extraordinarily conservative SAL of  $10^{-6}$  as a standard for all medical devices labeled sterile is counter-productive and, in some instances, very costly.

# Summary

Sterilization of medical devices, solutions, and other materials used for treatment of patients is perceived by both industry and health care professionals as necessary to prevent patient infections. Sterility is defined as an absolute condition and as the state of being free from all viable microorganisms. In practice, however, this categorical definition is not used. Instead, a manufacturer develops a sterilization process, based in part on microbiologic inactivation kinetics, that assures sterility of a medical device to a defined probability. The sterility assurance level, expressed as  $10^{-3}$  or  $10^{-6}$  (1/1000 or 1/1,000,000 chance, respectively, that an item is contaminated), is based primarily on the intended use of the device. Items with different SALs are not associated with different patient risks for infection. Rather, risk of patient infection as a result of using a sterile device is related to events and errors associated with the handling of the device and to a variety of patient factors and not to the SAL used in the manufacture of the sterile device.

# References

1. Banerjee SN, Emori TG, Culver DH, et al. Secular trends in nosocomial primary bloodstream infections in the United States, 1980 to 1989. *Am J Med* 1991;91:865-905.
2. Bruch CW. The philosophy of sterilization validation. In: Morrissey RF, Phillips GB, eds. *Sterilization Technology: A Practical Guide for Manufacturers and Users of Health Care Products*. New York: Van Nostrand Reinhold; 1993; 17-35.
3. Favero MS. Strategies for disinfection and sterilization of endoscopes: The gap between basic principles and actual practice. *Infect Control Hosp Epidemiol* 1991;12:279-281.
4. Favero MS, Alter MJ, Bland LA. Dialysis-associated infections and their control. In: Bennett JV, Brachman P, eds. *Hospital Infections*, 3rd edition. Boston/Toronto/London: Little, Brown and Co.; 1992; 375-403.
5. Favero MS, Bond WW. Chemical disinfection of medical and surgical materials. In: Block SS, ed. *Disinfection, Sterilization, and Preservations*, 4th edition. Philadelphia: Lea & Febiger; 1991; 617-641.
6. Jarvis WR, Epidemiology Branch, Hospital Infections Program. Nosocomial outbreak: The Centers for Disease Control's Hospital Infections Program Experience, 1980-1990. In: Martone WJ, Garner JS, eds. *The American Journal of Medicine*, Proceedings of the 3rd Decennial International Conference on Nosocomial Infections. New York: Cahners Publishing; 1990; 3B-101S-106S.
7. Jarvis WR, Edwards JR, Culver DH, et al. Nosocomial infection rates in adult and pediatric intensive care units in the United States. In: Martone WJ, Garner JS, eds. *The American Journal of Medicine*, Proceedings of the 3rd Decennial International Conference on Nosocomial Infections. New York: Cahners Publishing; 1990; 3B-185S-191S.
8. Kallings L, Ernerfeldt F, Silverstolpe L. Microbiological contamination of medical preparations. Report to the Swedish National Board of Health, Stockholm, 1965.
9. Maki DG. Infections due to infusion therapy. In: Bennett JV, Brachman P, eds. *Hospital Infections*, 3rd edition. Boston/Toronto/London: Little, Brown and Co.; 1992; 849-898.
10. Morrissey RF, Bruch CW, Sharbaugh RJ, et al. Sterility and safety assurance of medical devices. In: *Medical and Diagnostic Industry*. Santa Monica, California: Canon Communications; 1992; 78-81, 115.
11. Nichols RL. Surgical wound infection. In: Martone WJ, Garner JS, eds. *The American Journal of Medicine*, Proceedings of the 3rd Decennial International Conference on Nosocomial Infections. New York: Cahners Publishing; 1990; 3B-54S-64S.
12. Recommended practice for reuse of hemodialyzers. *Association for the Advancement of Medical Instrumentation*. Arlington VA; 1993.
13. Sjoberg L. Scandinavian regulatory viewpoint-sterile medical products. In: Gaughran ERL, Morrissey RF, eds. *Sterilization of Medical Products*, Volume 2. Montreal: Multiscience Publications; 1981; 294-299.



# ISO Standards Activities — The Challenges Ahead

William E. Young<sup>\*</sup> and Virginia C. Chamberlain, Ph.D.<sup>\*\*</sup>

*\*Baxter Healthcare Corporation, U.S.A.*

*\*\*U.S. Food and Drug Administration, U.S.A.*

# Introduction

In order to understand the sterilization challenges which lie ahead, one must first understand the emerging regional and international sterilization standards. This overview of draft standards will include information on the organizations which are developing sterilization standards, a listing and status of related standards, and challenges created by these standards.



# European Economic Area

Most of what will be discussed in this chapter can be traced back to the development of a European Economic Area which will allow free trade across the borders of the 12 European countries, thereby forming a single European Community (EC). In order to assure that products which move across borders are of comparable quality, a common set of requirements had to be established for each industry. These essential requirements are known as EC Directives. Upon demonstrated compliance with the EC Directives, the manufacturer may add the "CE" Mark to its product(s). The EC Directives are currently at varying stages of completion. The EC Directive for toys, for example, is already approved and some toy products are already bearing the "CE" Mark. On the other hand, there are three directives for medical devices; only the Active Implantable Medical Device Directive has been approved and was effective as of January 1, 1993. A common position was achieved on the Medical Device Directive in February of 1993 and final approval can be expected later in 1993. At this time there is only a working document for the *In-Vitro* Diagnostics Directive.

# European Committee for Standardization

The European Committee for Standardization (CEN) is developing standards which can be used to achieve compliance with the above directives. In addition to the 12 European countries, there are also six European Free Trade Association (EFTA) countries participating in the process. The standards are being developed in two formats. The first format is the vertical standard which provides the requirements for a given product type; the second format is the horizontal standard which provides requirements independent of product type. The CEN sterilization standards are therefore considered horizontal.

Standards are being developed by working groups within CEN Technical Committees which are comprised of members representing national standards bodies. Once the standards are drafted, they are subjected to formal reviews and revisions by the Working Group (WG) and then by the Technical Committee (TC). When the document reaches the proposed European Norm (prEN) stage, it is voted upon by the member countries in accordance with the weighting factors shown in Figure 1.

<u>EC Countries</u>	<u>Votes</u>	<u>EFTA Countries</u>	<u>Votes</u>
Belgium (IBN)	5	Austria (ON)	3
Denmark (DS)	3	Finland (SFS)	3
France (AFNOR)	10	Iceland (STRI)	1
Germany (DIN)	10	Norway (NSF)	3
Greece (ELOT)	5	Sweden (SIS)	5
Ireland (NSAI)	3	Switzerland (SNV)	5
Italy (UNI)	10		
Luxembourg (ITM)	2		
Netherlands (NNI)	5		
Portugal (IPQ)	5		
Spain (AENOR)	8		
United Kingdom (BSI)	10		

Figure 1. European Committee for Standardization (CEN) Members and Influence

## *CEN Sterilization Standards*

Sterilization standards for medical devices are being developed and/or coordinated by 13 working groups within the three CEN Technical Committees shown in Figure 2. As indicated earlier, these horizontal standards will be used to achieve compliance with the EC Directives on active implantable medical devices, medical devices, and *in vitro* diagnostics. The standards for sterilizer systems and testing thereof are being established by TC 102 while the sterilization process standards, including those for bioburden and sterility, are being finalized by TC 204. Finally, progress on international standards for ethylene oxide (EO) residuals is being monitored by TC 206. The programs of work and leadership for the three CEN technical committees are shown in Figure 3.

TC 102 - Sterilizers for Medical Purposes Chairperson: F. Peregrin
TC 204 - Sterilization of Medical Devices Chairperson: A.M. Emmerson
TC 206 - Biocompatibility of Medical and Dental Materials and Devices Chairperson: I.M. Dorpema

Figure 2. CEN Technical Committees

<u>TC</u>	<u>WG</u>	<u>Description</u>	<u>Convenor</u>	<u>Country</u>
102	1	Terminology	B. Simmons	UK
102	2	Combined with 3	K. Oates	UK
102	3	Steam Sterilizers	D. Achterberg	Germany
102	4	Sterile Packaging	T. Galekop	Belgium
102	5	Sm. Steam Sterilizers	J. van Asten	Netherlands
102	6	EO Sterilizers	E. Hoxey	UK
102	7	Bio. & Chem. Indicators	D. Hurrell	UK
204	1	Ethylene Oxide Ster.	H. Winckels	Netherlands
204	2	Radiation Ster.	P. Vidal	France
204	3	Moist Heat Ster.	K. Oates	UK
204	4	Coordination	All Convenors	N/A
204	5	Bioburden	E. Hoxey	UK
204	Ad Hoc	Sterility	A.M. Emmerson	UK
206		EO Residues	I.M. Dorpema	Netherlands

Figure 3. Programs of Work for CEN Technical Committees 102, 204, and 206

### *International Community*

In 1989, CEN/TC 204 held its first meeting which addressed the standards for the three main sterilization methods, namely ethylene oxide, radiation, and steam. This meeting was not open to non-European countries as its purpose was to develop standards which would be used to achieve compliance with the EC Directives. Also in 1989, an agreement was reached in Lisbon between the International Organization for Standardization (ISO) Executive Board and the CEN Administrative Board to exchange technical information. This agreement paved the way for greater involvement in international sterilization standards development.

With the door open for ISO involvement, the U.S. pursued and was awarded the Secretariat for an International Technical Committee on Sterilization of Healthcare Products (ISO/TC 198).

The first meeting of ISO/TC 198 occurred less than one year after the first CEN/TC 204 meeting.

There are currently 21 voting and 14 observing members participating in the development of international sterilization standards. Almost half of the voting membership and over one-third of the total membership is made up of CEN members (see Figure 4). Based on the high level of participation from the European Community, there are hopes for achieving a single set of harmonized standards.

<b><u>P-Members [Participating (Voting) Members]</u></b>		
Austria (ON)*	France (AFNOR)*	Phillipines (BPS)
Belgium (IBN)*	Germany (DIN)*	S. Africa (SABS)
Brazil (ABNT)	Ireland (NSAI)*	Spain (AENOR)*
Canada (SCC)	Italy (UNI)*	Sweden (SIS)*
China (CSBTS)	Japan (JISC)	Thailand (TISI)
Colombia (ICONTEC)	Netherlands (NNI)*	United Kingdom (BSI)*
Egypt (EOS)	Norway (NSF)*	USA (ANSI)
<b><u>O-Members [Observer (Non-Voting) Members]</u></b>		
Argentina (IRAM)	India (BIS)	Switzerland (SNV)*
Australia (SAA)	Israel (SII)	Tunisia (INNORPI)
Czechoslovakia (CSN)	Malaysia (SIRIM)	Turkey (TSE)
Denmark (DS)*	Poland (PKNiM)	Yugoslavia (SZS)
Finland (SFS)*	Saudi Arabia (SASO)	
* CEN Members		

Figure 4. International Organization for Standardization (ISO) Technical Committee 198 Membership

Within the U.S., the American National Standards Institute (ANSI) is the recognized member of ISO and therefore holds the voting position on all ISO-related activities. As ANSI does not have a recognized leadership in sterilization, it delegated the Secretariat for ISO/TC 198 activities to the Association for the Advancement of Medical Instrumentation (AAMI). A Technical Advisory Group (TAG), co-chaired by one U.S. Food and Drug Administration representative (V. Chamberlain) and one industry representative (W. Young), administers the U.S. activities. The U.S. TAG is comprised of representatives from medical device manufacturers, pharmaceutical and parenteral drug manufacturers, hospitals, consultants, sterilizer manufacturers, contract laboratories, and contract sterilizers. The existing AAMI working groups serve as sub-TAGs which provide technical input on the related standards.

At this time, there are 10 working groups within ISO which are developing standards for sterilization of health care products. Although in most cases the standards parallel CEN activity, the applicability of the ISO standards is not limited to medical devices. Nine of these standards emanate from ISO/TC 198. The remaining standard on ethylene oxide residuals has been drafted by a joint working group of ISO/TCs 194 and 198. Due to its impact on the EO sterilization process, there is a close working relationship between the membership of ISO/TC 198, ISO/TC 194, and CEN/TC 206. ISO/TC 198/WG 3 has also proposed to develop a second standard on moist heat sterilization which would be applicable to health care facilities. Figure 5

summarizes the current program of work and leadership for ISO/TC 198.

TC	WG	Description	Convener	Country
198	1	Ethylene Oxide Ster.	H. Winckels	Netherlands
198	2	Radiation Ster.	J. Masefield	US
198	3	Moist Heat Ster.	J. Schultz	US
198	4	Biological Indicators	G. Oxborrow	US
198	5	Terminology	J. Whitby	Canada
198	6	Chemical Indicators	J. van Asten	Netherlands
198	7	Sterile Packaging	G. Strohsheim	Germany
198	8	Microbiological Methods	H. Shaffer	US
198	9	Aseptic Filling	M. Korczynski	US
194	11*	EO Residuals	B. Page	US

\* Liason with ISO/TC 198

Figure 5. Programs of Work for ISO Technical Committees 194 and 198

The initial program of work for ISO/TC 198 included only Working Groups 1-6. Working Groups 7 and 8 were formed to develop international standards on sterilization-related items which were already progressing in CEN/TCs 102 and 204. WG 9 is the most recently formed working group and has no counterpart within the CEN TCs. The relationship between the working groups of the two ISO TCs and the three CEN TCs is shown in Figure 6.

Description of Work Items	ISO		CEN	
	TC	WG	TC	WG
Ethylene Oxide Ster	198	1	204	1
Radiation Ster	198	2	204	2
Moist Heat Ster	198	3	204	3
Biological Indicators	198	4	102	7
Terminology	198	5	102	1
Chemical Indicators	198	6	102	7
Sterile Packaging	198	7	102	4
Microbiological Methods	198	8	204	5
Aseptic Filling	198	9	-	-
Ethylene Oxide Residuals	194	11	206	.*
Sterility Requirements	-	-	204	Ad Hoc
Steam Sterilizers	-	-	102	3
Small Steam Sterilizers	-	-	102	5
EO Sterilizers	-	-	102	6

Figure 6. ISO/CEN Counterpart Standards

In 1991, an agreement was reached in Vienna between the ISO Executive Board and the CEN Administrative Board on technical cooperation. This agreement included, but was not limited to: 1) mutual representation at CEN and ISO meetings, 2) adoption of existing ISO standards as CEN standards and, 3) transfer of work and parallel voting on standards. Once again, the

incentives for working together were strengthened and the opportunities for harmonized standards increased.

# Status of Standards

These are very dynamic times with respect to the development, approval, and implementation of sterilization and related standards. Numerous ad hoc, WG, and TC meetings have been conducted in 1993. In addition, it is likely that a number of prENs will be approved as European Norms (ENs) or standards. It is also possible that more of the draft international standards will become approved ISO documents. For this reason, only a brief status of key standards which have reached the prEN or Draft International Standard (DIS) stage is provided.

## *Status of Key CEN Standards*

The CEN/TC 204 standards for EO, radiation, and steam sterilization have received approval by their respective working groups and the Technical Committee in September, 1992. These prENs, following translation into French, German, and English, will proceed to a 2-month formal vote. The ad hoc working group on sterility assurance requirements has advanced their prEN for a 2-month second CEN enquiry and Working Group 5 has advanced the requirement's section of the bioburden document for a 6-month, first CEN enquiry. A summary of these prENs is provided in Figure 7.

In addition, Working Group 7 within CEN/TC 102 has advanced its prENs on biological and chemical indicators for a 6-month, first CEN enquiry. The status of the other standards being developed within CEN/TC 102 is provided in Figure 8.

prEN	Description	Status
550	Ethylene Oxide Sterilization Requirements	Approved by WG-1 and TC 204 (9/92) and progressed to formal vote (2 months).
551	Ethylene Oxide Sterilization Guidance	Text incorporated into annex of 550.
552	Radiation Sterilization Requirements	Approved by WG-2 and TC 204 (9/92) and progressed to formal vote (2 months).
553	Radiation Sterilization Guidance	Text incorporated into annex of 552.
554	Moist Heat Sterilization Requirements	Approved by WG-3 and TC 204 (9/92) and progressed to formal vote (2 months).
555	Moist Heat Sterilization Guidance	Text incorporated into annex of 554.
556	Sterility Assurance Requirements	Approved by ad hoc WG and TC 204 (9/92) and submitted for 2nd CEN Enquiry (2 months).
N76	Bioburden Requirements	Submitted for 1st CEN Enquiry (6 months).

Figure 7. Status of CEN Technical Committee 204 Documents

WG	Description	Status
1	Terminology	Terminology is being harmonized between CEN/TC 204 and TC 102 documents.
2	Steam Sterilizers - Testing	This activity has been merged with WG 3.
3	Large Steam Sterilizers	prEN 285 circulated for 6 month enquiry.
4	Sterile Packaging	prEN 868 on the general requirements (horizontal) and 7 prEN's on specific materials (vertical) to be circulated following translation. Three additional vertical standards on Tyvek™ are under development.
5	Small Steam Sterilizers	Document is being developed as a working draft.
6	EO Sterilizers	prEN's to be circulated for 6 month enquiry following translation.
7	Biological and Chemical Indicators	prEN's 866 & 867 circulated for 6 month enquiry.

Figure 8. Status of CEN Technical Committee 102 Documents

### *Status of Key ISO Standards*

The ISO/TC 198 working groups for EO and radiation sterilization have reballoted their documents for a 2-month period. The ballot period for the radiation document ended on March 14, 1993 with an approved DIS plus comments to be reviewed at the next TC meeting. The ballot period for the EO document ended on June 22, 1993. Working Group 3 has completed the process for moist heat sterilization and ISO document #11134 has been approved for publication. This represents the first real opportunity for a harmonized standard to be adopted by the EC. The standards for biological and chemical indicators were balloted through July 14, 1993 as draft international standards. Lastly, the EO residues draft international standard of ISO/TC 194 was balloted in parallel within CEN and ISO commensurate with the Vienna Agreement. These and other standards being developed by ISO/TCs 198 and 194 are summarized in Figure 9.



WG	Document	Description	Status
1	DIS11135	Ethylene Oxide Sterilization	DIS11135 was not approvable. A second DIS (11135.2) has been sent out for a 2 month ballot - ending 6/22/93.
2	DIS11137	Radiation Sterilization	DIS11137 was approvable. A second DIS (11137.2) was sent out for a 2 month ballot which ended 3/14/93. The second DIS is also approvable.
2	CD13409	Validation of 25 kGy (Method 3)	The 3 month comment period on CD13409 ended 5/26/93. Comments to be discussed at August TC meeting.
3	ISO11134	Moist Heat Sterilization	Approved for publication.
4	DIS11138-1	Biological Indicators - General	DIS11138-1 was approvable. A second DIS (11138-1.2) is expected to be sent out for ballot following the August TC meeting.
4	CD11138-2	Biological Indicators for EO Sterilization	Comments to be discussed at August TC meeting. Documents may then be advanced to DIS stage.
4	CD11138-3	Biological Indicators for Steam Sterilization	Comments to be discussed at August TC meeting. Documents may then be advanced to DIS stage.
6	DIS11140	Chemical Indicators	DIS11140 sent out for a 6 month ballot ending 11/13/93.
7	CD11607-1 CD11607-2 CD11607-3	Sterile Packaging	The three month comment period on CD's 11607-1, 2 & 3 ended 5/26/93. Comments to be discussed at August TC meeting.
8	CD11737	Microbiological Methods	The three month comment period on CD11737 ended 5/26/93. Comments to be discussed at August TC meeting.
9	2nd Working Draft	Aseptic Filling	A 3rd working draft is expected by August TC meeting.
11*	DIS10993-7	EO Residuals	DIS10993-7 was sent out for a 6 month ballot - ending 7/14/93.

\* Liason with ISO/TC 194

Figure 9. Status of ISO Technical Committee 198 Documents

# Challenges Ahead

Despite the fact that many of these standards are approaching approval by the respective standards bodies, there are likely to be some requirements, as well as some guidance, which are not universally considered common practice. These challenges are described for each of the three sterilization methods in the remaining section of this paper.

## *Ethylene Oxide Sterilization*

Both CEN and ISO working groups for EO Sterilization were convened by H. Winckels of the Netherlands. This represents a real opportunity for harmonization, and today the CEN prEN and the ISO DIS are virtually identical documents. There will still be challenges with respect to qualification and release requirements as described below.

## ***Qualification Issues***

Although the achievement of relative humidity within the sterilization load is an expectation of preconditioning, it is not universally measured during qualification. Both standards currently require such measurements. If conditioning is used, with or without preconditioning, the same measurements are required. This is not common practice today since humidity sensors can represent a safety hazard when exposed to explosive EO mixtures and/or can be poisoned by EO gas. In addition, relative humidity can be estimated based on pressure rise in accordance with the ideal gas laws.

The sterilization load temperature must also be maintained throughout the exposure period which implies that it is achieved at the start of exposure. This is not always the case. In some cases, the achievement of temperature within the sterilization load is not required until the end of the half cycle. In these cases, the theoretical efficacy in the second half of exposure will be greater than in the first half which is microbiologically challenged.

In order to validate an overkill or 12D cycle, it has been generally expected that a 6 spore log reduction (SLR) of the biological indicator should be demonstrated in one-half the full exposure time. A 6 SLR could be demonstrated based on a most probable number (MPN) calculation in a half cycle which included fractional survivors. In order to use this approach, however, there must be evidence that the process was uniformly delivered and that the positive results are not indicative of locational deficiencies within the chamber. Use of this MPN calculation based on fraction survivors, however, will not be allowed by the emerging standards as they currently require total inactivation. This is unfortunate as one positive biological indicator (BI) result combined with 99 negative BI results from a uniformly delivered half cycle would demonstrate an 8 SLR and a corresponding 16 SLR or 16D full cycle. With this extent of treatment, even a product with an estimated bioburden of 1,000,000 organisms would be considered to have a SAL of  $10^{-10}$ .

There are also additional requirements for monitoring the efficacy of the aeration cycle to include temperature monitoring of the sterilization load and product testing for EO residues. These additional requirements stem from the view of pre- and post-sterilization treatments as “parts” of the sterilization process. This additional monitoring of product within “hold” areas following sterilization is not common practice.

## ***Conventional Release***

Although it is generally recognized that a very cold sterilization load (i.e., one that may have been transported between facilities during the winter months) may not be properly preconditioned, written specifications for load temperature are not yet common practice. Both of the standards will, however, require the minimum temperature of the sterilization load to be specified.

In addition, a secondary measure of EO concentration will be required by the standards. Typically the EO concentration is controlled and monitored by pressure. The secondary measure may be weight or volume of gas used. Weight of gas used is the more common approach and, although not required, is generally recommended.

Finally, the temperature and air change rate in the aeration area must be specified in accordance with the standards. For accelerated aeration areas, or chambers, this is generally common practice today. This is due to the post-sterilization treatment being viewed as an active process to reduce EO residues. Where product is merely being stored for a defined period within the facility prior to release, a specified temperature range and air change rate are less likely to be current practice.

## ***Parametric Release***

Although Parametric Release may be typical for steam- and radiation-sterilized products, it is not the most common form of release for EO-sterilized products because there are multiple parameters for the EO process which act synergistically to cause sterilization. For this reason, the standards require direct measurement of all parameters to include humidity, EO concentration, temperature, and time within the chamber. In addition, temperature within the sterilization load must also be monitored. This level of monitoring is not commonly practiced today and could be argued as being excessive for a properly validated sterilization process. However, Parametric Release is an optional method of releasing product and is now internationally recognized as being acceptable provided the above requirements are satisfied.

## ***Radiation Sterilization***

In the late 1950s, Dr. Artandi developed an “overkill” sterilization dose of 25 kilograys (kGy). This dose was capable of delivering a 12D cycle based on a radiation resistant organism (*Bacillus pumilus*) with a D-value of 2.1 kGy. This then became a generally accepted dose for radiation-sterilized products. In some countries, 25 kGy is still used with little or no testing of the naturally occurring bioburden.

More recent studies have demonstrated that the naturally occurring bioburden population can include isolates with D-values which are 1½-2 times greater than *B. pumilus*. For this reason, the CEN and ISO standards require testing of the naturally occurring bioburden as part of the validation of the sterilizing dose. Unfortunately, only AAMI dose setting Methods 1 and 2 are referenced in the CEN and ISO standards. Method 3 which offers an abbreviated validation program for products irradiated at 25 kGy is likely to be published in an ISO Technical Report – Type 2.

In addition, the Bioburden and Microbiological Standards of CEN and ISO, respectively, require that the methods used for bioburden recovery be validated. This means that the efficacy and reproducibility of the method must be demonstrated.

Finally, there will be a CEN standard which defines the sterility assurance Level for products labeled “sterile”. Although this standard applies to all terminally-sterilized medical devices, the greatest impact will be on irradiated products. This impact is based on the proposed SAL of  $10^{-6}$  for “sterile” medical devices. It is fully recognized that the sterility assurance level need not be the same for all medical devices based on their intended use, but CEN/TC 257 has classified “sterile” as a graphical symbol which must have a singular definition.

## ***Moist Heat Sterilization***

As evidenced by the approved ISO standard #11134 and the nearly final prEN #554, there are few, if any, issues to the users of these standards. This may be the case as steam sterilization is one of the oldest and best understood sterilization methods. It is simple and in many cases can be effectively characterized based on physical data only. The level of detail included in the standards is also less than that described in the other sterilization standards.

# Biological Indicators

The biological indicator standards are considered normative for ethylene oxide and moist heat sterilization standards. Therefore, these standards are important with respect to validating and monitoring the above sterilization processes.

As drafted, however, these standards differ from existing standards and pharmacopoeias with respect to the determination of resistance. For EO processes, the sterilization temperature used in the resistance determination is also different.

The precision of the inoculation level and/or recovery procedure must result in counts which are within 10% of the labeled population. This is not common practice and may not be achievable. In addition, the replicate enumerations must be within 5% of each other; this is even less likely to be achieved on a routine basis. Based on the above controversies, these standards may not progress as rapidly as some others and could present new challenges when approved.

# Conclusions

The development of international standards has been both challenging and rewarding. The challenges come from aggressive schedules, distant travel, and different time zones, languages, and regulatory perspectives. The rewards come from opening new lines of communication, sharing technical expertise and practical experience, and believing that the end result will likely improve the quality of medical care on a global basis.

It is clear that the emerging consensus on many of the ISO Draft International Standards would not have been possible without the existence of the draft European standards. Based on the similarities of the parallel standards, there is still hope for harmonized standards and, where this cannot be achieved in the time allowed, there will surely be further opportunities upon revision.





# Validation of Methods for Bioburden Estimation<sup>1</sup>

Eamonn V. Hoxey, Ph.D.

*Medical Device Directorate, U.K.*

# Introduction

The development of standards for sterilization processes is an activity for which significant resources are being committed at both the international and European standards levels. The initial work concentrated on developing standards for the major sterilization processes: ethylene oxide, irradiation, and moist heat. The completion of these process standards has permitted attention to be transferred to activities which support validation and routine control of sterilization processes, such as the estimation of bioburden.

Bioburden data have a role in the routine monitoring of manufacturing processes because the data integrate the effects of all measures employed in the manufacture of sterile products and, therefore, provide an overall monitor of the effectiveness of control of the manufacturing environment, materials, processes, and personnel. In addition, bioburden data can be used in the validation and assessment of the effectiveness of cleaning processes. The phasing out of chlorofluorocarbons (CFCs) is leading to a reassessment and, in many cases, replacement of cleaning processes used in the manufacture of medical devices. The quality of incoming materials, particularly materials that are potentially highly contaminated such as materials of natural origin used in the manufacture of medical devices, may be monitored by conducting estimations of bioburden.

The most significant use of bioburden data, however, is in the validation and routine control of sterilization processes. Bioburden data are important in this application because the extent of treatment of a sterilization process is a function of the bioburden on the product, the resistance of that bioburden, and the sterility assurance level (SAL) required. The assessment of bioburden, therefore, needs to consider the number of microorganisms which comprise the bioburden together with their identities. The identification of contaminants does not need to be exhaustive, but some presumptive identification to genus level provides useful information.

# Control of Laboratory Procedures

It is important that the methods used to estimate bioburden are controlled to ensure that bioburden data are valid and representative of the products which are being manufactured. The application of controlled laboratory procedures provides confidence in the results generated. In general, the need for confidence in the data resulting from inspections and tests has been widely recognized and has led to the application of good laboratory practices and quality systems laboratories. For example, International Standards Organization (ISO) Guide 25 details general requirements for the competence for calibration and testing laboratories (4). This standard specifies the principles required for a laboratory to be recognized as competent to carry out specific investigations. While ISO Guide 25 is general in nature, it is worth noting that it requires that the laboratory methods are fully documented and validated.

When good manufacturing practice and quality systems were first introduced into the manufacture of medical devices, there was a tendency to concentrate on introducing controls on manufacturing processes and testing involving metrology. On occasion, microbiology laboratories were left outside the quality system because it was considered that microbiology was more art than science. This situation, however, has changed markedly in the last few years and is being influenced by pressures from a number of directions, including safety legislation requiring safe systems of work in laboratories. Such systems require documentation to demonstrate safe working methods.

It is now widely recognized that it is a natural extension to apply the principles of quality systems to laboratory procedures and that the definition of laboratory methods increases reproducibility and aids the interpretation of data. The application of quality systems increases confidence in the data generated. This recognition that quality systems need to be applied to laboratory practices is reflected in the documents produced by the ISO on microbiological methods used in the control and monitoring of sterilization processes (5) and in the European Standards (CEN) documents on estimation of bioburden (2). These documents are principally aimed at identifying laboratory requirements to demonstrate that they have the ability to produce reliable bioburden data; for example, the current ISO document (5) states that for each product, the method selected for bioburden estimation should be validated to determine its effectiveness and reproducibility.

# Methods of Estimation of Bioburden

Any investigation into the bioburden on a medical device only produces an estimate of the number of microorganisms which are present. The purpose of validating the bioburden method is to establish the relationship between the estimate and the true number of microorganisms on the product as precisely and accurately as possible.

Whatever the application for bioburden data, the method that is used needs to be reproducible so that confidence can be placed on the data and the results generated on one occasion can be compared reliably with those generated previously. In addition, when bioburden data are being used in the validation of the sterilization process, it is important that the estimate obtained is as close as possible to the true level of the bioburden. In these situations, it is important to have as effective a bioburden method as possible.

One of the major problems in choosing and validating a bioburden method is the wide range of medical devices which are manufactured. This variety leads to wide differences in the level and composition of the bioburden which is present. Furthermore, the selection, optimization, and validation of a method for estimating bioburden will be influenced by factors including product configuration, materials used, manufacturing processes employed, and the manufacturing environment to which a product is exposed.

Medical devices may be manufactured from a wide variety of materials such as polymers, metals, cellulose, and animal tissues. The adhesion of contaminating microorganisms to different materials will vary considerably and, as a consequence, so will the effectiveness of a technique to remove microorganisms from the material (1).

Figure 1 illustrates the variation which can be encountered in the level of bioburden on medical devices. The magnitude of the bioburden is presented on a logarithmic scale. This Figure illustrates that the estimate of bioburden may vary from less than one microorganism per device to as high as  $10^9$  microorganisms in a material of animal origin prior to processing.

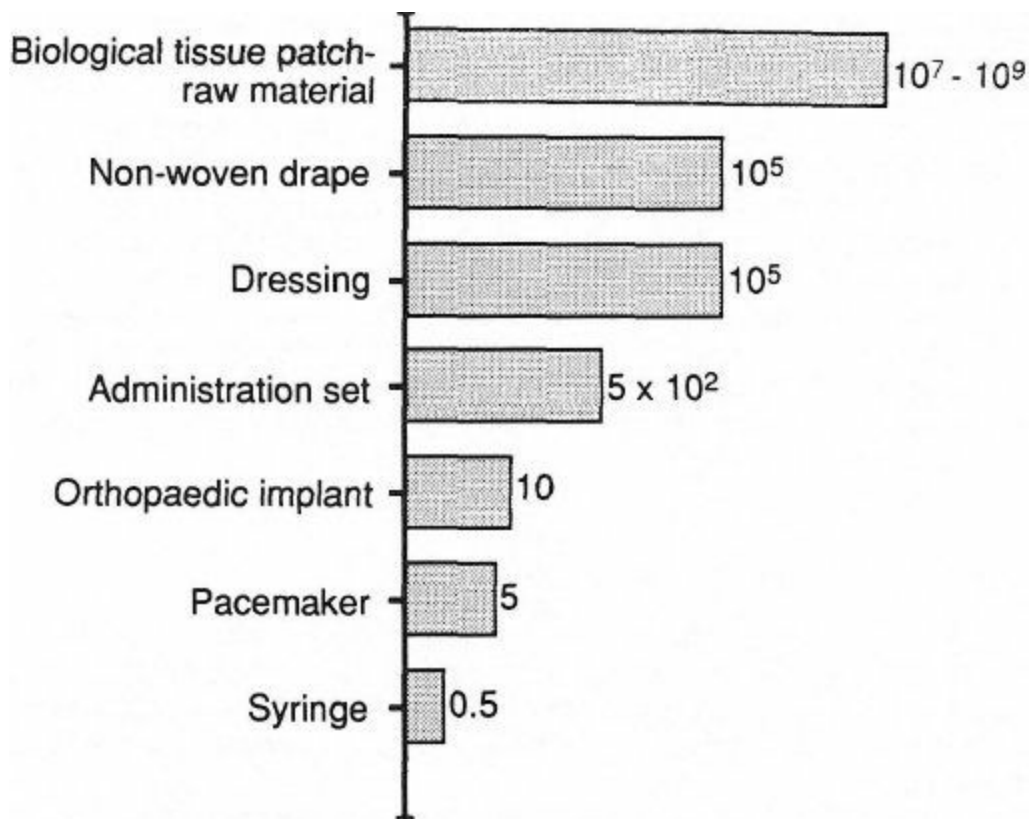

Figure 1. Magnitude of Bioburden on Devices

As a result of these wide variations, it is not possible to specify one method which can be used to estimate the bioburden on all products. Therefore, a method of estimating bioburden has to be selected based on a knowledge of the product and the way in which it is manufactured. Once a method has been selected, it is prudent to conduct a series of trials to investigate the applicability of the method for the particular product so that the method can be defined in sufficient detail for a meaningful validation exercise to be carried out.

# Validation of a Bioburden Method

The estimation of bioburden can be divided into three stages: 1) the removal of microorganisms comprising the bioburden from the device; 2) transfer of those microorganisms to the cultural conditions; and 3) enumeration of the microorganisms which have been removed. In order to establish any relationship between the bioburden on the product and the estimate obtained from the test method, it is necessary to consider the effect of all of these stages since they can impact the overall effectiveness of a bioburden method.

There are two methods available to validate the removal of microorganisms from a device: repetitive recovery and product inoculation (2,3,5,6). Each of these methods has advantages and disadvantages and each is suitable in certain applications.

The repetitive recovery technique involves exposing a single device to the method being validated on a number of sequential occasions and estimating the fraction of microorganisms which are removed on the first treatment. This method is practical when the bioburden is relatively high and the product is not destroyed by the repeated exposure to the recovery technique (3).

Product inoculation involves artificially contaminating a sterile product with a known number of microorganisms, usually bacterial spores. By exposing this product to the method being validated, the fraction of the microorganisms removed can be established. Although the relationship between the removal of microorganisms that have been used to contaminate the product artificially and the removal of natural microflora can be questioned, this method may be the only technique which is available for products with low bioburden (3).

After removing microorganisms from the product, they are transferred to the conditions which will be used for enumeration. This transfer may cause the loss of microorganisms, for example, as a result of osmotic shock or the presence of bactericidal materials extracted from the device. The effects of transfer therefore need to be established. This may be achieved, for example, by challenging the transfer process with a number of microorganisms which are known to be fragile and assessing the fraction which are lost during this transfer (3).

The counting technique itself also needs to be validated. Any one set of cultural conditions will only allow the detection of certain microorganisms. Therefore, the appropriateness of selected cultural conditions can be investigated, for example, by comparing the microorganisms isolated on the conditions which are being validated against a reference set of culture conditions which permit the isolation of a wide range of microbes. Clearly, some expertise is required in selecting an appropriate range of conditions and the comparison also requires identification of the microorganisms which are isolated since some contaminants will grow on more than one set of culture conditions (3).

# Conclusion

In order to use bioburden data effectively, it is important to demonstrate the validity of the data. Confidence in microbiological data comes from the application of good laboratory practice and quality systems in undertaking the microbiological test procedures. The validation of bioburden is an important element of the application of quality systems to microbiological testing.

# References

1. Dewhurst E, Rawson DM, Steele GC. The use of a model system to compare the efficiency of ultrasound and agitation in the recovery of *Bacillus subtilis* spores from polymer surfaces. *J Appl Bacteriol* 1986;61:357-363.
2. European Committee for Standardization, CEN. *Sterilization of Medical Devices — Estimation of the Population of Microorganisms on Product — Part 1: Requirements*. CEN TC 204 N128. Brussels: CEN; 1993.
3. European Committee for Standardization, CEN. *Sterilization of Medical Devices — Estimation of the Population of Microorganisms on Product — Part 2: Guidance*. CEN TC 204 N130. Brussels: CEN; 1993.
4. International Organization for Standardization, ISO. *Guide 25, General Requirements for the Competence of Calibration and Testing Laboratories*. Geneva: ISO; 1990.
5. International Organization for Standardization, ISO. *ISO CD 11737 Sterilization of Healthcare Products — Validation and Routine Control — Microbiological Methods*. Geneva: ISO; 1993.
6. Reich RR, Ottney RM. Validating bioburden recovery techniques. *Medical Device and Diagnostic Industry* 1992;14:88-94.

---

<sup>1</sup> The opinions presented in this paper are those of the author and do not necessarily represent the views of the U.K. Department of Health.





# **Establishing EO-Sterilization Residue Limits Using Health-Based Risk Assessment**

**Barry F.J. Page**

*Health Industry Manufacturers Association, U.S.A.*

# Introduction

The information in this paper is taken from the International Standards Organization (ISO) Draft International Standard (DIS): Biological Evaluation of Medical Devices — Part 7: Ethylene oxide sterilization residuals. More specifically, information from clause 1 and clause 2 of this document is presented to provide an understanding of the process used by the expert members of this working group for employing health-based risk assessment to establish EO-sterilization residue limits. As convener of this Working Group, I sincerely hope that this presentation adequately represents deliberations of this group during the past 2½ years.

ISO\TC 194\WG 11 has developed a draft international standard for EO-sterilization residuals. In this, devices are categorized by duration of contact. Procedures for establishing allowable limits for ethylene oxide (EO) and ethylene chlorohydrin (ECH) limits and their specific scientific rationales are described. The residue limits for EO in medical devices were established by applying methods proposed by the U.S. Pharmaceutical Manufacturers Association (PMA) for setting residue limits for organic volatile impurities in chronically administered pharmaceuticals (45). This procedure was modified to address systemic effects from limited exposure (< 24 hours) and from prolonged exposure (> 24 hours to 30 days). The approach required that all relevant data be evaluated by the limit setting process. The approach also was based on the concept that acute data should be the basis for acute limits, that subchronic and reproductive effects data should be the basis for prolonged exposure limits, and that chronic and carcinogenicity data should be the basis of permanent exposure limits.

# Device Categorization by Duration of Contact

Devices are categorized by duration of contact as specified in ISO 10993-1: 1992 subclause 5.2, and contact duration may be categorized as follows:

- a) limited exposure: devices whose single or multiple use<sup>1</sup> or contact is likely to be less than 24 hours;
- b) prolonged exposure: devices whose single, multiple, or long-term use or contact is likely to exceed 24 hours but not 30 days;
- c) permanent contact: devices whose single, multiple, or long-term use or contact is greater than 30 days.

There is a specific requirement that when devices in the use or contact duration category described in subclause 5.2 (a) are used periodically in a given month they should be included in the duration category described in subclause 5.2 (b).

If a material or device may be placed in more than one duration category, the more rigorous testing requirements should apply. With multiple exposures, the decision into which category a device is placed should take into account the potential cumulative effect, bearing in mind the period of time over which these exposures occur.

# Setting Limits for Residual EO and ECH

## Setting Residue Limits for EO

### Background

The residue limits for EO in medical devices were established by applying the methods proposed by the PMA (45). This procedure was modified to address systemic effects from limited exposure (< 24 hours) and systemic effects from prolonged exposure (> 24 hours to 30 days) (8). The approach required that all relevant data be evaluated in the limit setting process. This approach was also based on the concept that acute data should be the basis for acute limits, that subchronic and reproductive effects data should be the basis for prolonged exposure limits, and that chronic and carcinogenicity data should be the basis of permanent exposure limits.

**Table I. List of Safety Factors Used to Set Systemic Limits for EO**

Systemic Residue Limit	Type of Study	Dosage	Safety Factor <sup>1</sup>
Permanent Exposure	Chronic Toxicity (> 12 months treatment/exposure)	NOEL OR NOAEL	10
		LOEL or LOAEL	≥ 10
	Carcinogenicity	NOEL or NOAEL	100
		LOEL or LOAEL	≥ 100
Prolonged Exposure	Subchronic Toxicity ( 6 months treatment/exposure)	NOEL OR NOAEL	100
		LOEL or LOAEL	≥ 100
	Reproductive/Developmental Toxicity	NOEL or NOAEL	100
		LOEL or LOAEL	≥ 100
Limited Exposure	Acute Toxicity	LD <sub>50</sub> animal	> 100
		LDLo human or animal	≥ 10 or ≥ 100
		TDLo human or animal	> 1 or >10

<sup>1</sup> The actual safety factor used may be modified on the basis of the data under evaluation and on professional judgment. In each case, the additional modifying factor may range between 1 and 10. The actual safety margin represents a product of the safety factor and the modifying factor.

exposure, are used. Included in the consideration of the safety margin are: the extrapolation of animal data to humans, the quality of the study from which the limits are derived, the application of these limits to persons of low body weight, and the simultaneous use of several devices on a single individual. No values are attributed to any of these factors as the committee recognizes that these may be altered by the addition of data at the time of the next revision.

The general formula for calculating the systemic limit using safety factors was as follows:

$$\text{Limit (mg/day)} = \frac{\text{NOEL, LD}_{50}, \text{ etc. (mg/kg/day)} \times \text{human body mass (kg)}}{\text{Safety Margin (= Safety Factor} \times \text{Modifying Factor)}}$$

Where:

<i>NOEL</i>	is the no-observed-effect-level
<i>LOEL</i>	is the low-observed-effect-level
<i>NOAEL</i>	is the no-observed-adverse-effect-level
<i>LOAEL</i>	is the low-observed-adverse-effect-level
<i>LD</i> <sub>50</sub>	is the median lethal dosage
<i>LDLo</i>	is the low lethal dosage
<i>TDL0</i>	is the low toxic dosage

EO has produced tumors in several animal studies and is considered by regulatory agencies and consensus groups throughout the world to be a probable human carcinogen. Thus, statistical quantitative risk assessment of the data to establish residue limits for permanent exposure was also deemed appropriate. Since cancer risk estimates have been performed for EO by many groups, these estimates were used to provide a residue limit that would represent the worst-case lifetime daily dose of EO associated with a 1 in 10,000 excess cancer risk as proposed by the PMA for EO as an organic volatile impurity in chronically administered pharmaceuticals (46).

In summary, the EO limits in medical devices were established based upon evaluation of many literature reports and upon consideration of several reviews (6,10,13,14,16,46). Since the potential irritancy of a medical device sterilized with EO is evaluated by biological testing, acute toxicity data, target organ effects data, animal carcinogenicity data, and human tolerance data were deemed the most appropriate for the derivation of product residue limits for protection against potential adverse effects resulting from EO exposure. In addition, in evaluating the potential toxicity of EO, consideration should be given to the simultaneous use of more than one device and the use of devices in the treatment of neonates (13, ISO 10993-1, clause 6.1(b) (5)). This risk is deemed acceptable, in part, because of the benefits afforded by sterile medical devices in preventing nosocomial infections.

## ***Permanent Exposure Limit***

The exposure limit of 30 days or more to life is 0.1 mg/day, not to exceed 20 mg/day, 60 mg/month, or 2,500 mg/lifetime. This limit was based upon chronic toxicity and carcinogenicity data that have been reported by many investigators (11,33,34,42,55). With the exception of the Dunkelberg study (11), all were inhalation studies. No acceptable parenteral data were found.

In the Dunkelberg study animals were treated orally by gavage. Dosages ranged upwards from 2.1 mg/kg/day. In these studies, adverse target organ effects from chronic administration included decreased sperm function, skeletal muscle atrophy, and precancerous lesions to the stomach. Several types of cancer were also found, including mononuclear cell leukemia, primary brain tumours, parenteral mesotheliomas, subcutaneous fibromas, lung adenomas/carcinomas, Harderian gland papillary cystadenomas, lymphomas, uterine/mammary gland adenocarcinomas, and squamous cell carcinomas to the forestomach. These data were evaluated using both safety factor and statistical quantitative risk assessment techniques. While EO was considered to be a genotoxic carcinogen based upon its mutagenic potential and produced some tumor types in animals relevant to man, the lack of biodisposition data regarding EO in animals and humans and the lack of a clear epidemiology link between EO exposure and cancer in man precluded statistical quantitative risk assessment techniques as the sole means of calculation of the limit for permanent exposure to EO.

The key data that became the basis for the calculation of a prospective permanent exposure limit using safety factors are summarized in Table II. Inspection of these data reveals that LDLo dosages for EO for permanent exposure periods, i.e., 30 days to life, are comparable regardless of routes of exposure or effects, although no acceptable data from which to access effects from parenteral exposure are available.

**Table II. Summary of Data Used to Establish Permanent Exposure Limit for EO**

Data Type	Oral LOEL (mg/kg/day) [Reference]	Inhalation LOEL (mg/kg/day) [Reference]
Chronic Toxicity	2.1 – Prorated from 7.5 mg/kg twice weekly [11]	9.2 <sup>1</sup> [33]
Carcinogenicity	2.1 – Prorated from 7.5 mg/kg twice weekly [11]	2.1 <sup>2</sup> [55]

<sup>1</sup> Calculated from a LOEL value of 50 ppm in a 2-year study in Cynomolgus monkeys to assess sperm function. EO administered 7 hours/day for 5 days/week. Presumed ventilation rate and body weight of 1.2 m<sup>3</sup>/day and 2.7 kg, respectively.

<sup>2</sup> Calculated from a LOEL value of 10 ppm in a carcinogenicity study in rats administered EO for 6 hours/day for 5 days/week. Presumed ventilation rate of 290 liters/day and a body weight of 0.5 kg.

To provide the utmost protection to the patient, the lowest LOEL with cancer as the tissue response — i.e., a prorated oral dose of 2.1 mg/kg administered to rats for 3 years — was used as the basis for calculation of a prospective permanent exposure limit as follows:

$$\text{Prospective Limit} = \frac{\text{Dosage (mg/kg/day)} \times \text{BW}}{\text{SM}} = \frac{2.1 \times 70}{1000} = 0.15 \text{ mg/day}$$

Where:

- Dosage* is the lowest low-observed-effect-level in chronic toxicity or carcinogenicity studies.
- BW* is the adult body mass of 70 kg.
- SM* is the safety margin of 1,000 (safety factor of 100 times a modifying factor of 10) for translation of low effect data in cancer bioassays to man reflecting the fairly large incidence of stomach cancer in the study, variations in data, and lack of parenteral data.

Cancer risk estimates have been calculated for EO by numerous groups as cited by Environ (13). These groups, including the Food and Drug Administration, California Department of Health Services, Occupational Safety and Health Administration, and U.S. Environmental Protection Agency, have employed linearized multistage models or Gaylor-Kodell linear proportional methods to generate unit cancer risk estimates from leukemia, brain tumor, stomach tumor, and mesothelioma data reported in animal studies. These unit cancer risk estimates ranged from 0.016 to 0.35 (mg/kg/day)<sup>-1</sup>. Translating these values to average, lifetime daily doses for a 70 kg adult with a worst-case 1 in 10,000 excess cancer risk yields a range of 0.02 mg/day to 0.44 mg/day with a mean of 0.12 mg/day. An example of these calculations using a unit cancer risk of 0.016 (mg/kg/day)<sup>-1</sup> is as follows:

$$\text{Average Dose} = \frac{\text{Risk} \times \text{BW}}{\text{UCR}} = \frac{0.0001 \times 70}{0.016} = 0.44 \text{ mg/day}$$

Where:

- Risk* is the excess cancer risk of 1/10,000.
- BW* is the adult body mass of 70 kg.
- UCR* is the unit cancer risk in units of (mg/kg/day)<sup>-1</sup>.

Upon evaluation of the prospective limit of 0.15 mg/day and the worst-case 1 in 10,000 excess cancer risk dose of 0.12 mg/day, it was determined that 0.1 mg/day would be adequately protective of the adverse effects of EO resulting from permanent exposure. The permanent limit covers potential exposure for a very wide period of time, from 30 days to 25,000 days in a 70-year lifetime. Thus, the actual, worst-case cancer risk resulting from exposure to EO at this limit could be much less than 1 in 10,000 in many cases since the limit presumes daily exposure to EO for 70 years. A study of the use of medical devices sterilized by EO has resulted in the estimate that the actual probability of cancer from exposure to EO from medical devices is quite low, in the vicinity of 7 in one million (13).

### ***Prolonged Exposure Limit***

The exposure limit for 24 hours to 30 days is 2 mg/day, not to exceed 20 mg/day or 60 mg/month. This limit was based upon subchronic toxicity and reproductive effects data (teratogenicity, reproductive performance, fetotoxicity, etc.) generated in several species



(4,19,20,21,24,28,40,42,52-54,59). In oral, parenteral, and inhalation studies lasting for periods up to 226 days, EO has produced a wide variety of adverse effects including vomiting; tremors; respiratory irritation; injury to lungs, kidneys, testes, adrenals, thymus gland, liver and gastrointestinal tract; decreased growth and body mass; impairment of nervous system function; paralysis and muscular atrophy (hind limb); and anemia. Dosages ranged from 1 to  $\geq$  100 mg/kg. Reproductive studies included exposure of animals for up to 12 weeks prior to mating, exposure throughout all or part of gestation, and exposure for up to 21 days after parturition. Dosages ranged from 5 to  $\geq$  150 mg/kg. In these studies, EO produced maternal toxicity, embryotoxicity, fetotoxicity, delays in fetal development, and cervical/thoracic skeletal malformations. This latter effect has been observed only in the offspring of mice given EO intravenously at a dosage of 150 mg/kg, a dose corresponding to about one-third the LD<sub>50</sub> of EO in female mice of 360 mg/kg. The key data that became the basis for the calculation of the limit for prolonged exposure are summarized in Table III.

**Table III. Summary of Data Used to Establish Prolonged Exposure Limit for EO**

Study Type	Oral NOEL (mg/kg/day) [Reference]	Parenteral NOEL (mg/kg/day) [Reference]	Inhalation NOEL (mg/kg/day) [Reference]
Subchronic Toxicity	30 [20]	25 [40]	5 <sup>1</sup> [54]
Reproductive Toxicity	ND	9 [24]	13 <sup>2</sup> [52]

<sup>1</sup> Calculated from a NOEL value of 10 ppm in a 10-11 week study in mice administered EO for 6 hours/day for 5 days/week. Presumed ventilation rate of 43 liters/day and a body mass of 30 g.

<sup>2</sup> Calculated from a NOEL value of 33 ppm in a teratology study in pregnant rats administered EO for 6 hours/day during gestation days 6-15. Presumed ventilation rate of 290 liters/day and a body mass of 0.35 kg.

Inspection of the data in Table III suggests that the no-observed-effects-levels for EO for prolonged exposure periods, i.e., 1 day to 30 days, are comparable regardless of the route or type of effect, target organ, or reproductive effect.

To provide the utmost protection to the patient, the lowest NOEL for parenteral administration, 9 mg/kg from an intravenous, teratology study in rabbits, was used as the basis of the calculation of the limit for prolonged exposure as follows:

$$\text{Limit} = \frac{\text{Dosage (mg/kg/day)} \times \text{BW}}{\text{SM}} = \frac{9 \times 58}{250} = 2 \text{ mg/day}$$

Where:

*Dosage* is the lowest no-observed-effect-level in subchronic or reproductive effect studies by parenteral administration.

Single user license provided by AMM. Further reproduction or distribution is prohibited.  
*SM* is the female body mass of 58 kg since the data selected was a

*BW* teratology study in pregnant animals.

*SM* is the safety margin of 250 (safety factor of 100 times a modifying factor of 2.5) for translation of no-effect data in animals to reflect variation in species responses.

For a 58-kg adult, therefore, the limit thus provides at least a 250-fold safety margin from the potential adverse effects of EO resulting from prolonged exposure.

### **Limited Exposure Limit**

The exposure limit for less than 24 hours is 20 mg and is based upon acute toxicity data generated in several animal species (6,7,21,49,59). Although a limited amount of LDLo or TDLo data exist (46), LD<sub>50</sub> data were used because they were the only appropriate data available for the assessment. For the limited dose effect data which do exist, the dose response curves for these acute biological effects and the lethal and non-lethal dosages were quite close to each other and differed by a factor of less than 2. The LD<sub>50</sub> data for EO are summarized in Table IV.

**Table IV. Summary of Data Used to Establish the Limited Exposure Limit for EO: LD<sub>50</sub> Value and Species**

Oral LD <sub>50</sub> (mg/kg) [mean]	Intravenous LD <sub>50</sub> (mg/kg) [mean]	Intraperitoneal LD <sub>50</sub> (mg/kg) [mean]	Subcutaneous LD <sub>50</sub> (mg/kg) [mean]	Inhalation LD <sub>50</sub> (mg/kg) <sup>1</sup>
72, rat 240, rat 270, guinea pig 280, rat 280, mouse 330, rat 360, mouse 631, rabbit [380]	175, rabbit 178, rabbit 180, rabbit 260, mouse 290, mouse 350, rat 355, rat 380, rat [271]	150, rat 175, mouse 178, mouse 178, rat 180, rat 180, mouse 251, rabbit [185]	130, mouse 140, rat 187, rat 190, mouse 200, rabbit 260, mouse [185]	155-773 estimated

<sup>1</sup> Calculated from 4-hour LC<sub>50</sub> values of 800-4000 ppm in rats (with intermediate values for other species) using a body weight of 250 g and a ventilation rate of 290 liters/24 hours.

Inspection of these data suggests that the toxicity of EO for limited exposure periods, i.e., less than 24 hours, is comparable within a factor of about 3, regardless of the route of exposure. Since the data reflect median lethal dosages and not low lethal or low toxic dosages, the lowest of the LD<sub>50</sub> values, 72 mg/kg in rats, was used as the basis of the calculation of the limit for limited exposure as follows:

$$\text{Limit} = \frac{\text{Dosage (mg/kg/day)} \times \text{BW}}{\text{SM}} = \frac{72 \times 70}{250} = 20 \text{ mg/day}$$

*Dosage* is the lowest median lethal dosage (mg/kg).

*BW* is the adult body mass of 70 kg.

*SM* is a safety margin of 250 (safety factor of 100 times modifying factor of 2.5) for translation of acute data from animals to one-time exposure in humans.

For a 70-kg adult, the limit provides at least a 250-fold safety margin from the potential adverse effects of EO resulting from limited exposure based on animal data. Other acute effects such as haemolysis of blood cells do not appear to be a problem even if the entire maximum daily dose of 20 mg were to be delivered in a few minutes (43,56).

## ***Special Situations***

During the development of this international standard, three special situations were recognized in which the limits specified in Table VIII would not be practical due to limitations of the devices themselves or because human data existed which indicated that the dose levels shown in this Table were not applicable. Human data are available from patient exposure to intraocular devices which must be addressed by revision of the residue requirements for such devices. During treatment of blood with oxygenators or blood separators it is recognized that the medical benefit outweighs the risk and this is addressed in considering the allowable short-term limits for these devices. In the case of extracorporeal blood purification set-ups, long-term use could potentially lead to the maximum lifetime dose requirement being exceeded and this is also addressed.

***Intraocular Device Limit.*** Residue limit for intraocular devices (implant devices in the eye) is 0.5 µg/device based on the maximum tolerated concentration of EO (25 µg/g) in intraocular lenses from human use experience (51), modified to reflect the average mass of an intraocular lens of 20 mg.

***Blood Oxygenators and Blood Separators.*** The limited exposure limit for such devices is 60 mg in a 24-hour period. These devices are used in operations such as open heart surgery. This limit takes into consideration the acute need of the patient during such procedures while still allowing over an 80-fold safety factor. Under such circumstances this relaxation is warranted.

***Extracorporeal Blood Purification Set-Ups.*** The maximum allowable EO dose of 2.5 g per lifetime may be exceeded, provided that both the maximum daily EO dose of 20 mg and the maximum monthly EO dose of 60 mg are met. To exceed the 2.5 g lifetime dose of EO, a patient undergoing blood purification would need to be exposed to 2 mg EO 3 times every week and such exposure would need to continue for 8 years. If this worst case exposure were to continue for 70 years — and no one has undergone treatment for that long — the cancer risk would increase from 1 in 10,000 to about 1 in 1,000. This added cancer risk is balanced out by the benefit of lifetime blood purification.

### ***Setting Residue Limits for ECH***

The residue limits for ECH in medical devices were established using the methodology outlined above for EO with one exception. ECH has exhibited no potential to produce cancer in

bioassays in animals and is not considered a possible human carcinogen by regulatory agencies or consensus groups. Therefore, the statistical quantitative risk assessment methodology to establish a residue limit for permanent exposure that would represent a worst-case 1 in 10,000 excess cancer risk was not applied. The limits for ECH in medical devices were established based upon the evaluation of many literature reports. Acute toxicity data, target organ effects data, and animal chronic toxicity data were deemed the most appropriate for the derivation of the limits themselves.

## ***General Considerations***

The acute toxicity data and repeated dose data demonstrate that ECH is readily accessible to systemic circulation following dermal, oral, and parenteral exposure. Inspection of the LD<sub>50</sub> and no-observed-effect levels also suggest that the potency of ECH at specific time intervals is comparable by oral and parenteral routes of exposure. Based upon data generated in subchronic and chronic toxicity studies, ECH does not appear to become more potent as the duration of exposure is increased. While ECH is not notable for its target organ toxicity, specific target organ effects can vary with route and duration of exposure. The allowable daily dose limits that are discussed in the reactions that follow reflect these general observations.

## ***Permanent Exposure Limit***

The exposure limit of 30 days or more to life is 2 mg/day, not to exceed 12 mg/day, 60 mg/month, or 50,000 mg/lifetime. This limit was based upon chronic toxicity and carcinogenicity data that have been reported by Johnson (23), Mason et al (35), and NTP (41). In these respective studies, rats received ECH in drinking water until 24 months of age, rats received ECH by subcutaneous injection twice weekly for at least a year, and rats and mice received ECH by dermal application for 103 to 104 weeks. Dosages ranged from 0.086 to  $\geq 71$  mg/kg/day. In these studies, no increase in tumor incidence related to ECH administration or evidence of chronic toxicity (apart from a possible reduction in survival rates [23]) were found. The key data that became the basis for the calculation of prospective permanent exposure limits are summarized in Table V.

**Table V. Summary of Data Used to Establish the Permanent Exposure Limit for ECH**

Study Type	Oral NOEL (mg/kg/day) [Reference]	Parenteral NOEL (mg/kg/day) [Reference]	Dermal NOEL (mg/kg/day) [Reference]
Chronic	4 LOEL [23]	2.9 Prorated from 10 twice weekly [35]	ND
Carcinogenicity	16 <sup>1</sup> [23]	ND	71 Prorated from 100 five times weekly [41]

<sup>1</sup> Ethylene chlorohydrin produced no increase in tumor incidence at the highest dosage tested.

Inspection of these data suggests that the no-observed-effect-levels for ECH for permanent exposure periods, i.e., 30 days to life, by oral and parenteral routes are comparable, and these levels are comparable to those generated in subchronic and reproductive toxicity studies. Animals are more sensitive to the general systemic toxicity of ECH than to its potential, if any, to produce cancer.

To provide the utmost protection to the patient, the lowest no-observed-effect-level for chronic toxicity, 2.9 mg/kg/day administered subcutaneously to rats for at least a year, and for tumor production, 16 mg/kg/day orally to rats until 24 months of age, were used for the basis for calculations of a prospective permanent exposure limit as follows:

$$\begin{aligned} \text{Prospective Limit (Chronic)} &= \frac{\text{Dosage (mg/kg/day)} \times \text{BW}}{\text{SM}} \\ &= \frac{2.9 \times 70}{100} = 2 \text{ mg/day} \end{aligned}$$

Where:

- Dosage* is the lowest no-observed-effect-level for chronic effects.  
*BW* is the adult body mass of 70 kg.  
*SM* is the safety margin of 100 (safety factor of 10 times a modifying factor of 10) reflecting a conservative translation of animal data to humans.

$$\begin{aligned} \text{Prospective Limit (Cancer)} &= \frac{\text{Dosage (mg/kg/day)} \times \text{BW}}{\text{SM}} \\ &= \frac{16 \times 70}{100} = 11 \text{ mg/day} \end{aligned}$$

Where:

- Dosage* is the lowest no-observed-effect-level for tumor production (in fact, no increase in tumor incidence occurred).  
*BW* is the adult body mass of 70 kg.  
*SM* is the safety margin of 100 (safety factor of 100 times a modifying factor of 1) reflecting the lack of tumor production in animal bioassays.

Upon examination of these prospective limits, 2 and 11 mg/day, it was determined that 2 mg/day would be adequately protective of the adverse effects of ECH resulting from permanent exposure. This limit provides at least a 100-fold safety margin for a 70-kg adult for the potential adverse effects of ECH resulting from permanent exposure.

## ***Prolonged Exposure Limit***

The exposure limit for 24 hours to 30 days is 2 mg/day, not to exceed 12 mg/day or 60 mg/month. This limit was based upon subchronic toxicity and reproductive effects data (teratogenicity) generated in several species (1,2,4,9,25,26,44,59).

In repeated-dose oral and parenteral studies lasting for varying time periods up to 403 days, ECH produced a variety of adverse effects, including death (accompanied by increased relative organ masses, darkened mottled liver, hemorrhagic adrenals, hemorrhagic pituitary gland, hemorrhagic gastrointestinal tract, myocarditis, thyroid congestion, and congestive pulmonary changes in one study); decreased body mass and growth; increased brain, adrenal, kidney, lung, and thyroid masses; small testes or testicular injury; emesis; decreased hemoglobin, packed cell values, and hematocrit; liver injury; ectopic hematopoiesis and bone marrow hypercellularity; and a shift in white blood cells towards lymphocytes. Dosages ranged from about 2.7 to  $\geq 93$  mg/kg/day. In the teratology studies, ECH was administered for various time periods during gestation; maternal toxicity, fetal toxicity and, in one study, an increase in fetal malformations were apparent in these studies. This latter effect was observed only in the offspring of mice given ECH intravenously at a dosage of 120 mg/kg/day which is in the acute lethal range (26). The key data that became the basis for the calculation of the limit for prolonged exposure are summarized in Table VI.

**Table VI. Summary of Data Used to Establish the Prolonged Exposure Limit for ECH**

Study Type	Oral NOEL (mg/kg/day) [Reference]	Parenteral NOEL (mg/kg/day) [Reference]
Subchronic	13 [44]	2.7 Prorated from 6.4 three times weekly [31]
Reproductive	50 [9]	9 [25]

Inspection of these data suggests that the no-observed-effects-levels of ECH for prolonged exposure periods, i.e., 1 to 30 days, are comparable regardless of the route, specific target organ, or reproductive effects. Animals may be more sensitive to the general systemic toxicity of ECH than to its ability to produce adverse changes to reproduction. To provide the utmost protection to the patient, the lowest no-observed-effect-level was used — 2.7 mg/kg from an intraperitoneal study in rats — as the basis of the calculation of the limit for prolonged exposure as follows:

$$\text{Limit} = \frac{\text{Dosage (mg/kg/day)} \times \text{BW}}{\text{SM}} = \frac{2.7 \times 70}{100} = 1.9 \text{ mg/day}$$

Where:

*Dosage* is the lowest no-observed-effect-level in subchronic and reproductive effects studies by parenteral administration.

*BW* is the adult body mass of 70 kg.

*SM* is the safety margin of 100 (safety factor of 100 times a modifying factor of 1).

While the calculated limit is slightly less than the actual limit itself (1.9 mg/day versus 2 mg/day), the latter limit is considered to be adequately protective in light of the observation that ECH does not increase toxicity after chronic versus prolonged exposure. The limit provides almost a 100-fold safety margin for a 70-kg adult from the potential adverse effects of ECH resulting from prolonged exposure.

## Limited Exposure Limit

The exposure limit for less than 24 hours is 12 mg. This limit was based upon acute toxicity data generated in several animal species (30,32,35,47,50,58,59). Although a limited amount of acute data, other than medium lethal dosages, were available and evaluated, they were not considered appropriate for this assessment. The median lethal dosage data are summarized in Table VII.

**Table VII. Summary of Data Used to Establish the Limited Exposure Limit for ECH**

Oral LD <sub>50</sub> (mg/kg) [mean]	Intravenous LD <sub>50</sub> (mg/kg) [mean]	Intraperitoneal LD <sub>50</sub> (mg/kg) [mean]	Subcutaneous LD <sub>50</sub> (mg/kg) [mean]	Other LD <sub>50</sub> (mg/kg)
50, rat	67, rat	44, rat	60, rat	<i>Skin</i> 67.8, rabbit 84, guinea pig
60, rat	80, rabbit	58, rat	72, rat	
60, rabbit	84, rat	60, rat	100, rabbit	
70, rat	100, rat	63, rat	120, mouse	
71.3, rat	110, rat	64, rat	150, mouse	
72, rat	120, mouse	70, rat		
80, mouse		80, rabbit		
81.4, mouse		84.6, rabbit		
91, mouse		85, guinea pig		
95, mouse		85.5, guinea pig		
110, guinea pig		90, rabbit		
150, mouse		97, mouse		
180, mouse		98.4, mouse		
		120, mouse		
		130, mouse		
[90]	[94]	[82]	[100]	

Inspection of the data in Table VII suggests that the toxicity of ECH for limited exposure, i.e., less than 24 hours, is nearly identical regardless of the route of exposure. Since the data reflect median lethal dosages and not low-lethal or low-toxic dosages, the lowest LD<sub>50</sub> value — 44 mg/kg in rats by intraperitoneal administration — was used rather than an intermediate value. The basis of the calculation of the limit for limited exposure is as follows:

$$\text{Limit} = \frac{\text{Dosage (mg/kg/day)} \times \text{BW}}{\text{SM}} = \frac{44 \times 70}{250} = 12 \text{ mg/day}$$



*Dosage* is the lowest median lethal dosage (mg/kg).

*BW* is the adult body mass of 70 kg.

*SM* is the safety margin of 250 (safety factor of 100 times a modifying factor of 2.5) for translation of acute data from animals to one-time exposure in humans.

This limit provides at least a 250-fold safety margin for a 70-kg adult from the potential adverse effects of ECH resulting from limited exposure.

# Residue Limits for Ethylene Glycol

A risk assessment of ethylene glycol (EG), performed using the same method that was used for EO and ECH, was discussed at length by the Working Group. The assessment indicated limited exposures of 435-588 mg/day would be acceptable based upon acute exposures to animals (27,35,39,48,50,55,60) and humans (48). Prolonged exposures of 30 mg/day or 900 mg/month would be acceptable based upon subchronic and reproductive effects data in animals (15,55,57), and permanent exposures of 30 mg/day or 750 g/lifetime would be acceptable based upon chronic toxicity and negative carcinogenicity data (5,12,35,39). No maximum allowable residue limits are required for ethylene glycol. When EO residues are controlled to the limits specified herein it is unlikely that a biologically significant amount of EG would remain on a device.

# Allowable Limits for EO and ECH

The maximum allowable dose of EO and ECH delivered to a patient for each medical device to be in compliance with this international standard shall not exceed the values given in Table VIII.

**Table VIII. Residue Limits for EO and ECH in Each Medical Device in Terms of Delivered Dose of EO and ECH to Patients<sup>a</sup>**

<b>AVERAGE DELIVERED DOSE OF EO and ECH (mg/day)</b>			
<p>The device must be placed first in an exposure category as defined. Once this has been accomplished, the following requirements apply: For EO, the maximum daily dose is 20 mg/day, the maximum monthly dose is 60 mg/month, and the maximum lifetime dose is 2.5 g. For ECH, the maximum daily dose is 12 mg/day, the maximum monthly dose is 60 mg/month, and the maximum lifetime dose is 50 g. Also, the EO and ECH residue on the device should not produce unacceptable irritation or other adverse effects in appropriate biological tests.</p>			
<b>RESIDUE</b>	<b>PERMANENT CONTACT<sup>1</sup> (&gt;30 days to life)</b>	<b>PROLONGED EXPOSURE<sup>1</sup> (24 hours to 30 days)</b>	<b>LIMITED EXPOSURE (24 hours)</b>
EO	0.1 <sup>2,3</sup>	2	20 <sup>4</sup>
ECH	2	2	12
<p><sup>1</sup> Values for prolonged exposure and permanent contact expressed as average daily doses with the stipulation that the shorter-term limits shall not be exceeded.  <sup>2</sup> Residue of EO in intraocular devices shall not exceed 0.5 µg EO per device.  <sup>3</sup> For extracorporeal blood purification set-ups, the maximum daily EO dose shall not exceed 20 mg and the maximum monthly EO dose shall not exceed 60 mg, but the allowable EO dose for a lifetime may be exceeded.  <sup>4</sup> For blood oxygenators and blood separators, the maximum allowable EO dose for limited exposure shall not exceed 60 mg.</p>			

<sup>a</sup> In multi-component devices, the limits apply to each item individually.

# References

1. Alleva F. (Cited in Balazs, 1976).
2. Ambrose A. Toxicological studies of compounds investigated for use as inhibitors of biological processes. II. Toxicity of ethylene chlorohydrin. *Arch Ind Hyg Occup Med* 1950;2:582-597.
3. Andersen S. Ethylene oxide toxicity. *J Lab Clin Med* 1971;77(2):346-356.
4. Balazs T. Toxicity of ethylene oxide and chloroethanol. FDA By-lines No. 3:1976; 150-155.
5. Blood F. Chronic toxicity of ethylene glycol in the rat. *Food Cosmet Tox* 1965;3:229-234.
6. Bruch CW. *Industrial Sterilization*. Phillips GB, Miller WS, eds. Durham, NC: Duke University Press; 1973; 49-77.
7. Carpenter C, Smyth H, Pozzani U. The assay of acute vapor toxicity, and the grading and interpretation of results on 96 chemical compounds. *J Ind Hyg Toxicol* 1949; 31:343-349 (Cited in EPA, 1985).
8. Conine D, Naumann B, Hecker L. Setting health-based residue limits for contaminants in pharmaceuticals and medical devices. *Quality Assurance: Good Practice, Regulation, and Law*. 1992;1:171-180.
9. Courtney K, Andrews J, Grady M. Teratogenic evaluation of ethylene chlorohydrin (ECH, 2-chloroethanol) in mice. *J Environ Sci Health* 1982;B17(4):381-391.
10. Cyr WH, Glaser ZR, Jacobs ME. CDRH risk assessment of EO residues on sterilized medical devices. In: Jorkasky J, ed. *Sterilization in the 1990s*. HIMA Report No. 89-1. Health Industry Manufacturers Association: Washington, DC; 1989; 269-285.
11. Dunkelberg H. Carcinogenicity of ethylene oxide and 1,2-propylene oxide upon intragastric administration to rats. *Br J Cancer* 1982;46:924-933.
12. DePass L, Garman R, Woodside M, Giddens W, Maronpot R, Weil C. Chronic toxicity and carcinogenicity studies of ethylene glycol in rats and mice. *Fund Appl Tox* 1986; 7:547-565.
13. Environ. *Ethylene Oxide Residues on Sterilized Medical Devices*. Environ Corporation Washington, D.C., 1987; and *Ethylene Oxide Residues on Sterilized Devices. HIMA Report 88-6*. Health Industry Manufacturers Association: Washington, DC; 1988.
14. EPA. *Health Assessment Document for Ethylene Oxide*. EPA: 600/8-84-009F. U.S. Environmental Protection Agency. Research Triangle Park, NC, 1985.
15. Gaunt J, Hardy J, Gangolli S, Butterworth K, Lloyd A. *BIBRA* 1975;14:109 (Cited in Rowe and Wolf, 1982 and Environ, 1987).
16. Glaser ZR. Ethylene Oxide: Toxicology review and field study results of hospital use. *J Environ Path Tox* 1979;2;173-208.
17. Golberg L. *Hazard Assessment of Ethylene Oxide*. Boca Raton, FL: CRC Press; 1986.
18. Guess W. Tissue reactions to 2-chloroethanol in rabbits. *Tox Appl Pharm* 1970; 16:382-390.
19. Hackett P, Brown R, Buschboom R, et al. *Teratogenic Study of Ethylene Oxide and Propylene Oxide and n-Butyl Acetate*. NIOSH Contract No. 210-80-0013. Battelle Pacific Northwest Laboratories, Richland, WA, 1982. (Cited in EPA, 1985).
20. Hollingsworth R, Rowe V, Oyen F, McCallister D, Spencer H. Toxicity of ethylene oxide determined on experimental animals. *AMA Arch Ind Health* 1956;13:217-227.
21. Jacobson K, Hackley E, Femsilver L. The toxicity of inhaled ethylene oxide and propylene

oxide vapors. *AMA Arch Ind Health* 1956;13:237-244.

22. Johnson M. Metabolism of chloroethanol in the rat. *Biochem Pharmacol* 1967a; 16:185-199.
23. Johnson M. Detoxication of ethylene chlorohydrin. *Food Cosmet Tox* 1967b;5:449.
24. Jones-Price C, Kimmel T, Markes T, et al. *Teratologic Evaluation of Ethylene Oxide (CAS No. 75-78-8) in New Zealand White Rabbits*. Final Report (RB80-EO). NIEHS Contract No. 1-ES-2127. Research Triangle Park, NC, 1982. (cited in EPA, 1985).
25. Jones-Price C, Marks T, Ledoux T, et al. *Teratologic Evaluation of Ethylene Chlorohydrin (CAS No. 107-07-3) in New Zealand White Rabbits*. PB85-170959. National Institute of Environmental Health Sciences. Research Triangle Park, NC, 1985a.
26. Jones-Price C, Marks T, Ledoux T, et al. *Teratologic Evaluation of Ethylene Chlorohydrin (CAS No. 107-07-3) in CD-1 mice*. PB85-172104. National Institute of Environmental Health Sciences. Research Triangle Park, NC, 1985b.
27. Karel L, Landing B, Harvey T. The intraperitoneal toxicity of some glycols, glycol ethers, glycol esters and phthalates in mice. *Fed Proceedings* 1947;6:342.
28. LaBorde J, Kimmel C. The teratogenicity of ethylene oxide administered intravenously to mice. *Tox Appl Pharm* 1980;56:16-22.
29. Latven A, Molitor H. Comparison of the toxic, hypnotic and irritating properties of eight organic solvents. *J Pharm Exp Ther* 1939;65:89-94.
30. Lawrence W, Turner J, Autian J. Toxicity of ethylene chlorohydrin I: Acute toxicity studies. *J Pharm Sci* 1971a;60(4):568-571.
31. Lawrence W, Itoh K, Turner J, Autian J. Toxicity of ethylene chlorohydrin II: Subchronic toxicity and special tests. *J Pharm Sci* 1971b;60(8):1163-1168.
32. Lawrence W, Dillingham E, Turner J, Autian J. Toxicity profile of chloroacetaldehyde. *J Pharm Sci* 1972;61(1):19-25.
33. Lynch D, Lewis T, Moorman W, Sabharwal P, Burg J. Toxic and mutagenic effects of ethylene oxide and propylene oxide on spermatogenic functions in *Cynomolgus* monkeys. *Toxicologist* 1983;3:60.
34. Lynch D, Lewis T, Moorman W, et al. Carcinogenic and toxicologic effects of inhaled ethylene oxide and propylene oxide in F 344 rats. *Tox Appl Pharm* 1984;76:69-84.
35. Mason M, Cate C, Baker J. Toxicology and carcinogenesis of various chemicals used in the preparation of vaccines. *Clin Toxicol* 1971;4(2):185-204.
36. McDonald T, Roberts M, Borgmann A. Ocular toxicity of ethylene chlorohydrin and ethylene glycol in rabbit eyes. *Tox Appl Pharm* 1972;21:143-150.
37. McDonald T, Kasten K, Hervey R, Gregg S, Borgmann A, Murcheson T. Acute ocular toxicity of ethylene oxide, ethylene glycol and ethylene chlorohydrin. *Bull Parent Drug Assoc* 1973;27(4):153-164.
38. McDonald T, Kasten K, Hervey R, Gregg S, Button B. Acute ocular toxicity for normal and irritated rabbit eyes and subacute ocular toxicity for ethylene oxide, ethylene chlorohydrin and ethylene glycol. *Bull Parent Drug Assoc* 1977;31(1):25-32.
39. Morris T, Nelson M, Calvery A. Observations on the chronic toxicities of propylene glycol, ethylene glycol, diethylene glycol, ethylene glycol mono-ethyl-ether, and diethylene glycol mono-methyl-ether. *J Pharm Exp Ther* 1942;74:266-273.

40. Northup S, Weinckowski D, Martis L, Darby T. Toxicity caused by acute and subacute intravenous administration of ethylene oxide in the rat. *J Environ Pathol Toxicol* 1981; 5:617-623.
41. NTP. *Toxicology and Carcinogenicity Studies of 2-Chloroethanol (Ethylene Chlorohydrin) (CAS. No 107-07-3) in F344/N Rats and Swiss CD-1 Mice (Dermal Studies)*. NTP TR275. NIH Publication 86-2531. National Toxicology Program. Research Triangle Park, NC, 1985.
42. NTP. *Toxicology and Carcinogenicity Studies of Ethylene Oxide (CAS No. 75-21-8) in B6C3F1 Mice (Inhalation Studies)*. NTP TR326. U.S. Department of Health and Human Services. Public Health Services. National Institute of Health. Research Triangle Park, NC, 1987.
43. Ohba T. Safety of residual ethylene oxide and ethylene oxide concentrations in the working environment of sterilization facilities. In: Gaughren E, Morrissey R, You-sen W., eds. *Sterilization of Medical Products Volume IV*. Montreal, Canada: Polyscience Publications, Inc; 1986; 172-177.
44. Oser B, Morgareidge K, Cox G, Carson J. Short-term toxicity of ethylene chlorohydrin (ECH) in rats, dogs and monkeys. *Food Cosmet Tox* 1975;13:313-315.
45. PMA. *Procedures for Setting Limits for Volatile Organic Solvents with Methylene Chloride as an Example of the Process*. Committee on Rational Specifications for Impurities in Bulk Drug Substances — Pharmaceutical Manufacturers Association. Washington, DC. *Pharmacoepial Forum* November-December 1989; 5748-5759.
46. PMA. Application of the PMA procedure for setting residue limits for organic volatile solvents in pharmaceuticals to ethylene oxide. Prepared by D.L. Conine and the PMA subcommittee of Industrial Toxicologists. In: *Procedures for setting limits for organic volatile solvents with chloroform, 1,4-dioxane, ethylene oxide, and trichloroethylene as examples of the process*. Committee on Rational Specifications for Impurities in Bulk Drug Substances — Pharmaceutical Manufacturers Association. *Pharmacoepial Forum* May-June 1990; 557-572.
47. Rowe V, McCollister S. Alcohols. Chapter Fifty-Five. In: Clayton G, Clayton F., eds. *Patty's Industrial Hygiene and Toxicology. 3rd ed. Vol. 2C Toxicology*. New York, NY: John Wiley & Sons, Inc.; 1982; 4675-4684.
48. Rowe V, Wolf M. Glycols. Chapter Fifty. In: Clayton G, Clayton F, eds. *Patty's Industrial Hygiene and Toxicology. 3rd ed. Vol. 2C Toxicology*. New York, NY: John Wiley & Sons, Inc.; 1982; 3817-3832.
49. RTECS. *Registry of Toxic Effects of Chemical Substances 1985-1986*. National Institute for Occupational Safety and Health. DHHS (NIOSH) Publication No. 87-114. Rockville, MD. 1987; 2361-2362.
50. RTECS. *Registry of Toxic Effects of Chemical Substances*. National Institute for Occupational Safety and Health. On-line. 1990.
51. Shimizu H, Ohara K, Sawa M. Sterile anterior segment inflammation presumably due to absorbed ethylene oxide to the implanted intraocular lens. *Rinsho Ganka (Japanese J Clin Ophthalmol)* 1986;40(11):1219-1225.
52. Snellings W, Maronpot R, Zelenak J, Laffoon C. Teratology study in Fischer 344 rats exposed to ethylene oxide by inhalation. *Tox Appl Pharm* 1982a;64:476-481.
53. Snellings W, Zelenak J, Weil C. Effects on reproduction in Fischer rats exposed to ethylene oxide by inhalation for one generation. *Tox Appl Pharm* 1982b;63:382-388.

54. Snellings W, Weil C, Maronpot R. A subchronic inhalation study on the toxicologic potential of ethylene oxide in B6C3F1 mice. *Tox Appl Pharm* 1984a;76:510-518.
55. Snellings W, Weil C, Maronpot R. A two-year inhalation study of the carcinogenic potential of ethylene oxide in Fischer 344 rats. *Tox Appl Pharm* 1984b;75:105-117.
56. Tanaka S, Nakaura S, Kawashima K, Kasuya Y, Omori Y. Studies on the hemolytic activity and dermal irritability of ethylene oxide and its reaction products. *Jap J Med Instrum* 1982;52(1):21-28
57. Tyl R. *Developmental Toxicity Evaluation of Ethylene Glycol Administrated by Gavage to DC(R)-1 Mice: Determination of a "No-Observable-Effect Level" (NOEL)*. Report 51-591. Bushy Run Research Center. Union Carbide Corporation, Export, PA. (Study sponsored by Ethylene Glycol Panel. Chemical Manufacturers Association. Washington, DC, 1988.
58. Weil C. Statistics vs. safety factors and scientific judgement in the evaluation of safety for man. *Tox Appl Pharm* 1972;21:454-463.
59. Woodard G, Woodard M. Toxicity of residuals from ethylene oxide gas sterilization. *Proceedings of the Health Industry Association Technical Symposium*. Washington, DC, 1971;140-161.
60. Yin L, Liu C, Shih L, Po K. A study of the teratogenic action of ethylene glycol in rats. *Zhonghua Yugangyixue Zazhi* 1986;20(5):289-290.

---

<sup>1</sup> For clarification, multiple use is defined specifically as it is applied in this part of ISO 10993 to mean repeated use of the same device as presented for use by the manufacturer.





# DISCUSSION

## Risks, Standards, and Methods

## **Question for Ms. Duncan, Medical Devices Directorate, U.K.:**

It appears that the U.K. Department of Health is not yet ready to recognize that a sterility assurance level of  $10^{-6}$  can be achieved with a radiation dose of less than 25 kGy regardless of the quantity or quality of data. Could you comment?

## **Answer by Ms. Duncan:**

I think that we are talking not about what the U.K. Department of Health is recognizing but about the European standards. These standards are going to provide the legal basis against which future directives in the U.K., as well as other European countries, will be bound. Although the standards themselves will not be legal, companies will use them to assume compliance with the directives. Dr. Hoxey's presentation regarding bioburden data indicates that achieving the right quantity and quality of data may still be difficult for many companies. The U.K. was probably the first country to allow parametric release in a number of sterilization processes.

# **Question for Dr. Wartenberg, UMDNJ — Robert Wood Johnson Medical School, U.S.A.:**

Is it useful to attach an uncertainly limit when defining a risk as a probability?

## Answer by Dr. Wartenberg:

The answer is yes with qualification. There has been a whole area within risk assessment which has developed in the last few years to model this uncertainty. In this model, each of the numbers that goes into the calculation of the final risk is examined, and the uncertainty or the distribution of each is estimated. These are then combined to arrive at an eventual distribution of uncertainty for the final risk estimate. I find this useful at some level. There are some interesting caveats to make, however. In general, when animal toxicity data is used it turns out that the uncertainty in those data are much greater than everything else; they account for as much as two-thirds to three-quarters of the total uncertainty. A recent report by the National Academy of Sciences suggests the uncertainty is even greater because the cancer potency seems to be to a substantial degree dependent upon the doses at which the experiments were run. These are based on the compound's acute toxicity, i.e., the maximum tolerated dose, rather than on anything intrinsic about the chemical's chronic effects. The second issue is that when risk assessments are performed in the U.S., the EPA guidelines are followed and a dose-response model, called the delinearized multistage model, is used. This tends to fit most data reasonably well, although there are certainly other mathematical or statistical models that could be used to fit the data. The question I would raise is how does one estimate the uncertainty of using the wrong model? This is a fundamental issue that ought to be addressed in trying to look at uncertainty in risk assessments.

## Question for Dr. Favero, Centers for Disease Control, U.S.A.:

Historically, why was  $10^{-6}$  linked with the word “sterile” if this link has no rationale?

## Answer by Dr. Favero:

I am not quite sure how  $10^{-6}$  became indelibly linked with the word “sterile.” My guess is that when microbiologists began to run steam autoclaves with biological indicators, it became an easy and achievable way to quantitate sterility. I think that as time went on, the level stuck and we institutionalized the  $10^{-6}$  level because it was easy to achieve. It wasn't until the last 10 to 15 years that the ease of achieving this sterility assurance level was replaced with considerations of cost, materials, compatibility, and so forth and that consideration of what relevance this level had to patients, vis-à-vis hospital-acquired infections, was addressed. I can tell you that most of us in the infection control community do not understand sterility assurance levels. The converse is also true. Most of us who have to deal with sterility assurance levels and setting them do not understand the epidemiology of hospital-acquired infections and the link between the two.

## Comment by Ms. Duncan:

I'd like to comment again on the earlier question addressed to me which asked about accepting a sterility assurance level of  $10^{-6}$  for radiation. The U.K. never used the  $10^{-6}$  level as a radiation requirement, they set a dose. The first time those figures ever appeared was when a committee was looking at how to accept ethylene oxide sterilization processes in the days when people were achieving humidity in an ethylene oxide sterilizer by throwing a bucket of water on the floor of it or by aiming a hose through the door. Trying to set some kind of standard in those days was a very difficult one. A group of microbiologists, including Dr. Kelsey, sorted out a biological monitor, *Bacillus subtilis*, not because it was the most resistant organism to ethylene oxide, but because it was an easily reproducible one that could be clearly identified and was susceptible to ethylene oxide. After discussion about how many biological monitors to use in the process, they kicked out a figure of  $10^{-6}$ . Whenever we have a problem with sterilization, our primary concern is whether there are any nonsterile products out there. If there are, the issue becomes how many products are out there and how many patients are likely to be exposed. These issues have nothing to do with probabilities of  $10^{-3}$  or  $10^{-6}$ . These are professional estimations of risk. By putting "sterile" on a label, you have commercial, product, and legal liabilities.



## **Question for Mr. Young, Baxter Healthcare Corporation, U.S.A.:**

Why must relative humidity be measured within the sterilization load during conditioning in the sterilizer if such measurements have been made during preconditioning?

## **Answer by Mr. Young:**

Let me point out that both preconditioning and conditioning are not required in either the CEN or ISO standards. It is acceptable to have preconditioning without conditioning and vice versa. If the process is based on the achievement of temperature and relative humidity within the preconditioning step and a conditioning step is not mandatory within the sterilization cycle itself, it need not be performed. However, if conditioning is used to assure that temperature and relative humidity conditions have been achieved prior to exposure, the efficacy of the conditioning step within the sterilization cycle must be measured.

## Question for Mr. Young:

What effect does ethylene oxide have on humidity sensors during a sterilization cycle?

## **Answer by Mr. Young:**

Direct exposure of the humidity sensor to ethylene oxide and its reaction products may change the sensitivity of the device, and therefore, periodic cleaning and recalibration are recommended. However, as there is no requirement for measuring relative humidity during exposure, the efficacy of conditioning can be validated without gas addition.

## **Question for Dr. Hoxey, Medical Device Directorate, U.K.:**

If I were validating a process, I would assume the worst case of 10 or 50 organisms per syringe, and if I base my sterilization validation on worst case estimates, why should I become so fancy on the validation of removal? Please comment.

## **Answer by Dr. Hoxey:**

I think what the real question is is how do you know what your safety margin is if you have not estimated some sort of correction factor. If you have not done the experiment, there is nothing to base your judgment on. You can make judgments only after you have data. The precision and accuracy of the data depends on what you are going to do with it.

# **Question for Dr. Page, Health Industry Manufacturers Association, U.S.A.:**

When establishing the safety margin, why are a range of safety factors used instead of only one value?

## **Answer by Dr. Page:**

The type of factors that are considered in developing the safety margin are the extrapolation of animal data to humans, the quality of the study that is being reviewed, the application of the limits to persons of low body weight, and the simultaneous use of several devices on a single individual. These factors were considered by the working group, but no particular values were attributed to any of them. They were all combined into the general consideration of the safety margin.



## Question for Dr. Page:

What, if anything, is being done to assure that regulatory authorities will accept the ethylene oxide and ethylene chlorohydrin limits of the ISO standard?

## **Answer by Dr. Page:**

I don't know. We have been working with the FDA in the U.S. for a long time, but I am unsure of what experience others have had in their own countries in terms of getting regulatory authorities to accept these limits.

## **Comment by Dr. Hoxey:**

This situation points out the significant difference between ISO standards and CEN standards. If the document is published as a European norm, is harmonized, and printed in the official journal of the European Communities, any company complying with that standard will be presumed to be in compliance with the requirements of the European directive.

## Question for Dr. Page:

Did the working group perform a calculation to determine the similarity or relevancy of the mg per day dosage as it relates to the FDA guideline requirements associated with parts per million per device?

## **Answer by Dr. Page:**

The value that has been established by the working group for prolonged exposure is very similar to the basis FDA used to set the limit of parts per million in their 1978 proposal. The limits that we have established for permanent exposure are more stringent than the limits that FDA established. The limits for rare devices that are only used on a single day would be perceived to be somewhat more relaxed than the original FDA proposal.

## **Question for Dr. Hoxey:**

What is a reasonable frequency for assessing bioburden levels from an established product manufacturing line?

## **Answer by Dr. Hoxey:**

The answer to that question depends on many factors, primarily on how much data there are to demonstrate control over the process for a period of time. This determines how frequently monitoring needs to be conducted.

## **Comment by Carl Bruch:**

I am concerned that you advocate continuous bioburden estimates relative to a product line. It appears that in Europe you are looking for months and years of data, while in the U.S. many small companies would never be able to achieve this and it would increase the cost of products. The issue is how safe is the medical device in terms of the sterilization cycle it received, not how frequently bioburden was monitored.



## **Comment by Dr. Hoxey:**

In order to demonstrate control of the process, a company must monitor bioburden over a suitable frequency. This will depend on how much data are available, how many variables there are in the process, how often the manufacturing line runs, what the product is, what the environment is, and what other controls exist. I do not believe it is possible to say that bioburden determinations will be conducted at a specific frequency because it is an individual judgment based on the product, the manufacturing environment, and the conditions under which it is carried out. The current European document does not specify frequency. It does, however, require that a frequency be set but it does not indicate what that frequency should be. The philosophy is that this frequency is dependent upon the product and the manufacturing process.

## **Comment by Ms. Duncan:**

Although it has been many years since I performed factory inspections, I still remember bioburden data which covered four seasons of the year and showed tremendous variations depending on the climate. These variations will, of course, differ from country to country depending on how the climate changes. Other factors which may affect bioburden data include the staff and how well trained they are, i.e., whether they are allowed to leave doors open or forget to wash their hands. Knowing what a sterilization process can achieve is vital; however, since a company is trying to determine a sterility assurance level, increasing the bioburden by 10- or 100-fold will certainly change this level.

## **Question for Dr. Wartenberg:**

As an environmental epidemiologist, do you feel that quantitative risk assessment can be used more effectively to answer public concerns relating to radiation hazards? How would you propose improved public education of quantitative risk assessment techniques to counter the cynicism which has developed for radiation estimates.

## **Answer by Dr. Wartenberg:**

I assume this question relates to ionizing radiation. In New Jersey, we have a fairly substantial problem with exposure to radon in the ground which is a radiation issue in terms of lung cancer. It appears that there is public awareness of the difference between the risks associated with nuclear power versus radon, although both are radiation issues. This indicates that there is a real difference in how people understand the issues. This may be due to the perceived catastrophic potential of ionized radiation that people perceive and the public cynicism about the risk estimates that were provided about nuclear power. The public was told that the likelihood of an accident at one of these facilities was vanishingly small and then one occurred in the U.S. as well as around the world. Problems developed that people were told were not going to happen. This undermined any confidence the public might have had in the ability of scientists to make predictions. Therefore, you must involve the public in the process of risk assessment from the very beginning by listening to their concerns and accepting them as valid. When this is done, the public often better appreciates the scope of the problem.

## Question for Dr. Wartenberg:

Environmental risk assessment today is supposed to be more a problem of social acceptance rather than a scientific one. Many people still smoke cigarettes or stay on adventure holidays, both which have measurable risks, whereas these same people will reject living near a nuclear power station or high voltage lines.

## **Answer by Dr. Wartenberg:**

The notion of a risk or hazard is a multidimensional problem and quantitative risk assessment is only one piece of information that can be used in the management process. We can quantify things, but there are many other aspects that have to be considered in trying to reach a policy or management decision.

## **Comment from the Floor:**

There is a significant difference between the mathematical appreciation of risk which we get in the scientific audience and the appreciation of risk to the average population. The general population thinks more in terms of contrasting one risk with another, i.e., the risk of contracting something in a hospital is far less than the risk of getting killed in a car accident going to that hospital. A figure of 1 in 1,000,000 means nothing.

## **Comment by Dr. Wartenberg:**

Trying to present the notion of risk in terms of numbers is fairly difficult but I also think it is important to look at the context of a risk assessment in determining whether it makes sense. The risk of getting hit by an airplane when you are on the ground is a fairly rare event, greater than 1 in 1,000,000 over the course of a lifetime. This notion is used in advising patients in a clinical setting who are concerned about a hazardous exposure and therefore want to start smoking or taking tranquilizers because they are so upset; the patient is counseled that the risk they are going to incur by the behavior in response to the hazard is more serious than the risk they had from the original hazard. These numbers take on a different meaning, however, when there is widescale exposure to a population and in fact, government intervention may then be appropriate.



**Session IV**  
**Radiation Sterilization**  
**Chairman: Kenneth H. Chadwick**  
*European Commission*



# Opening Remarks

Kenneth H. Chadwick, Ph.D.

*Commission of the European Communities, Belgium*

Anyone who works in the field of radiation protection is only too aware of the emotive reactions which the word radiation invokes, and yet radiation is a very valuable tool in many industrial processes. The application of radiation in industrial processes continues to increase and many participants at this meeting would probably be surprised if they knew the extent to which radiation-processed products impinge on their daily lives. The applications cover areas such as heat shrinkable plastics, tire production, manufacture of semi-conductors, monomer polymerization for cable insulation and plastic wood composites, waste water treatment, food preservation by irradiation, and last but by no means least, sterilization of medical products.

All of these processes use large doses of radiation to achieve either specific chemical reactions, or in the case of waste water treatment, food preservation, and sterilization of medical products, bacterial decontamination. I have always regretted the fact that the food preservation process has not achieved its full potential, probably as a result of political over-caution and poor public information coupled with a fear of the word "radiation".

The sterilization of medical products is probably the most successful application of radiation processing that I am aware of and it is of direct benefit to the health of the population. Indeed, the advent of radiation sterilization of medical products, coupled with the rapid development of the plastics industry, almost certainly ushered in a totally new approach to medical hygiene in the form of single-use disposable medical products. Radiation has certain advantages over other forms of sterilization in that it leaves no residues, does not noticeably increase the temperature of the product, and most importantly can be used to sterilize pre-packaged sealed products and thus avoid any possibility of bacterial recontamination.

Radiation sterilization of medical products began in the 1950s when applications were being sought for the large amounts of radioactive cobalt which were a by-product from reactor development programs. I think it is important to note that Johnson & Johnson, through Ethicon, was involved in the process from its inception as a result of the vision of Dr. Charles Artandi among others. In 1956, Artandi and Van Winkle published a paper on the destruction of a large number of different bacterial strains by radiation. Since that time, Johnson & Johnson has been involved in the process and has played an important role in its development. I can still remember two Johnson & Johnson-sponsored meetings on Radiation Sterilization in 1974 and 1977 in Vienna, Austria where the argument raged over the level of sterilization dose needed. Since then, Johnson & Johnson has sponsored several Kilmer Memorial Conferences in different parts of the world.

It has been several years since I have been directly involved in the measurement of large radiation doses but it is clear to me from reading the abstracts of the presentations for this session that things are moving along as they should. The presentations in this session cover the

design of accelerator facilities, radiation dosimetry and dose setting, and process control by data management and by measurement of effect. It is interesting that two presentations deal with accelerator facilities as only a few years ago cobalt-60 gamma ray facilities were the vogue for the treatment of bulk products. The dosimetry and process control presentations highlight the great emphasis which is given to ensuring that the process is carried out correctly. Quality control is of utmost importance in this process which has direct relevance for public health.



# Design and Development of a Unique Electron Accelerator Facility

Thierry Descamps

*Mölnlycke S.A., Belgium*

Any company involved in the sterilization of its products must be vigilant as to the evolution of sterilization methods. Moreover, the evolution of the design of products can impact the sterilization methods used, and regulatory requirements and safety concerns can clearly alter the environment in which the sterilization activities are performed.

In the late 1980s, my company decided to discontinue, wherever possible, ethylene oxide sterilization. Radiation sterilization was selected as the alternative technology to be considered for future in-house sterilization. After our initial analysis of available technologies, we undertook a study of the feasibility of installing an electron beam sterilization plant.

# Electron Beam Accelerator Specifications

The first specification to be laid down concerned the electron beam equipment. The choice of the electron accelerator considerably influences the other equipment; both the shielded and the conveyor system have to be designed with regard to the accelerator chosen. For our application, power levels between 30 and 50 kW were considered and we selected a 40 kW accelerator of 10 MeV electrons.

A combination of two accelerators was necessary to reach the required power level. These two accelerators are placed on the same product conveyor line, oriented opposite of each other, so that irradiation of products from two sides can be performed in one single pass in the irradiation cell. The specifications for our accelerator are summarized as follows:

- **power level:** variable from 0 to 20 kW
- **energy:** 10 MeV
- **beam:** bended 107°, straightened before window
- **output window:** 1 m long, beam width adjustable between 40 cm and 80 cm
- **interface:** the two machines shall work as a single device

From the defined design of the electron beam generated by two machines, the shielded area could be drafted. The concept is based on a three level irradiation cell: one underground level receiving the accelerator for bottom sterilization; one middle level corresponding to the factory level constituting the product path; and one level on the first floor for top sterilization. Radiation resistance of compounds and ozone degradation risk have been seriously considered for minimizing their effects on the production environment and equipment.

# Product Handling System Specifications

The product handling system meets the requirements for handling standardized units. The europallet format is the chosen standard at the start and end of the line, and products are processed automatically in their final packaging without use of supplementary trays. The extreme dimensions of the products to be processed in the automatic mode are within the limits shown in Table I.

**Table I. Extreme Dimensions of Product Boxes for Irradiation Sterilization by Electron Beam Accelerator**

Dimension	Minimum	Maximum
Length	400 mm	800 mm
Width	300 mm	600 mm
Height	220 mm	700 mm

Other specifications of the product handling system are summarized as follows:

- a depalletizing unit has the role to line-up the product carton,
- a bar-code label is applied on each carton allowing unique identification,
- the position of each carton during the process is known exactly,
- the speed of the process conveyor is adjustable between 0 and 500 cm/minute,
- the process speed is controlled by the power of the accelerators,
- a 90° turning device reorients cartons correctly,
- a palletizing unit reconstructs the original pallet,
- reprocessing of a pallet in case of single accelerator process is possible.

Both the electron beam equipment and the product handling system must function in good coordination. All mechanical systems are controlled by programmable logic controllers (PLCs) and are connected to a main computer for data centralization. This system manages the qualitative and quantitative aspects of product sterilization. Behind the dimensional requirements, the level of minimum dose found in products and the max/min ratios calculated for each product results in reorientation of the products when necessary. In our facility, the maximum surface weight that can be sterilized using double-sided irradiation with 10 MeV electrons is approximately 6.5 g/cm<sup>2</sup>.

Considering the specific example of an assembly of a non-woven fabric with a polymer film in which the product is designed to be sterilized in a stack of horizontal laying products, the surface weight calculation gives 23 products as a maximum stack (see Figure 1).



Maximum surface weight to be sterilized using double-sided irradiation with 10 MeV electrons =  $6.5 \text{ g/cm}^2$

Unit surface weight of product to be sterilized =  $170 \text{ g}/598 \text{ cm}^2 = 0.284 \text{ g/cm}^2$

Maximum number of products that can be sterilized =  $6.5 \text{ g/cm}^2 / 0.284 \text{ g/cm}^2$  or 22.8 products

Figure 1. Minimum Dose Estimation

Figure 2 shows the absorbed radiation dose in each of the 25 products comprising a stack processed in our facility. The depth-dose curve indicates that 50% of the surface dose was not obtained in the three middle products. Redesign of the product consisting of 20 pieces gave acceptable process parameters.

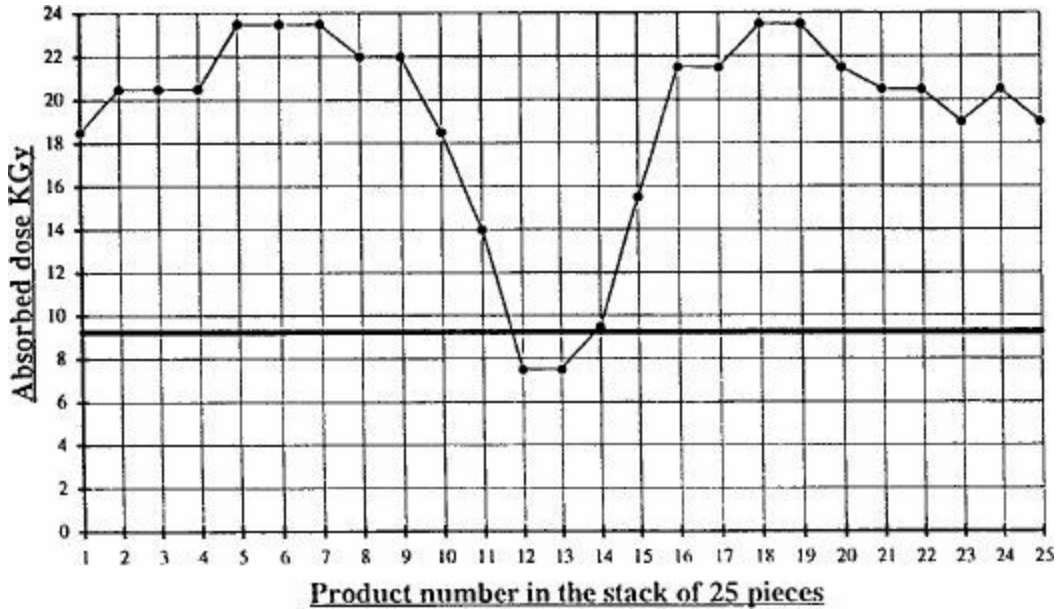

Figure 3. Absorbed Dose in a Stack of Products

# Compliance with European Draft Standard for Irradiation Sterilization

The technologies chosen, measuring methods, and monitoring capabilities by my company are in accord with the requirements stated in the draft European standard for sterilization by irradiation. In the draft standard, the choice of sterilizing dose is based on a treatment using a minimum dose of 25 kGy. The evidence that such a dose gives a sufficient level of inactivation is established by determining the spread and highest value for the D-values in each production site supplying goods to the sterilization plant. The precontamination bioburden performed on each production batch must remain under the critical levels established for each plant in accordance with the resistances found.

Our chosen dosimetric system also corresponds to the requirements set forth in the draft standard. During the installation qualification, the following parameters are controlled:

- The beam current is measured by a calibrated coil after bending, and corrected for the further losses between the measuring point and the product by means of a target absorbing the electrons after the output window.
- The electron energy is calculated from the depth-dose curve in aluminum.
- The scan width and scan uniformity are measured by CTA dosimeters.
- The monitoring system of the conveyor speed is easily calibrated.
- A dose mapping is performed on a reference product of polystyrene of 0.1 g/mL density.

The process specification for a product corresponds to the description of the product in its final packaging since this packaging corresponds to the irradiation container. The orientation for processing is fixed and identified in the process pattern. The specification is completed by the data generated in the performance qualification exercises, including minimum and maximum doses and conveyor speed. The data are stored for a standard reference power and will be recalculated to real operational conditions.

The monitoring activities are based on the permanent reading of beam power and conveyor speed. Other parameters such as electron energy and scan width are not directly controlled yet. The values of the current applied in the bending magnet and in the scanning magnet and time synchronization during pulses are continuously monitored. Direct monitoring systems for these parameters are currently under development.

Records are kept for each production batch, and are traceable to each product unit of the batch. The documentation covers the following data:

- minimum, maximum, and average dose,
- beam power,
- conveyor speed,
- bending and scanning magnet current,
- time and date of irradiation,
- type and timing of errors that occur.

The freedom in designing a new sterilization facility, the ease of measuring operational parameters, the development of monitoring systems for better parameter control, and the

existence of draft regulatory requirements have all contributed to the selection and design of our electron beam sterilization plant. Further developments in on-line monitoring of all process parameters will fully open the concept of product parametric release for this technology.



# ESR-Based Analysis in Radiation Processing

William L. McLaughlin<sup>\*</sup>, Marc F. Desrosiers<sup>\*</sup>, and Michael C. Saylor<sup>\*\*</sup>

*<sup>\*</sup>National Institute of Standards and Technology, U.S.A.*

*<sup>\*\*</sup>Dunn-Loring, Virginia, U.S.A.*

# Introduction

Electron spin resonance (ESR)<sup>1</sup> analysis of irradiated materials, especially polyolefins, polystyrene, and specialty resins, is a well-established technology (10,11,12). Most studies of irradiated polymers by ESR spectrometry have been directed to the understanding of radiation damage effects (28,51) and to ways of limiting the damage by the addition of certain organic lubricants and antioxidants (5,72). Work by Morita et al (44) has demonstrated that it is possible to explain by ESR analysis the reaction kinetics caused by radiolytic peroxy, methoxy, and alkyl radicals in polymers, as well as the protective role played by light stabilizers (e.g., hindered-amine polycyclic compounds) in polymers. ESR can also be used to register images of absorbed dose distributions in key polymers such as polypropylene (44). The most significant radiation effect in plastics, and in both organic and inorganic solid-state substances, is damage caused largely by radiation-induced free-radicals that can have a long latency period. These effects often result in the eventual coloration, embrittlement, and other losses of mechanical strength and durability of these materials.

The use of ESR for analysis of stable free radicals as a means of radiation dosimetry also has a long history (6,7,9,56,60). In spite of its birth more than 30 years ago, however, ESR dosimetry still has to prove itself as an established, commercially-viable method of measurement for industrial processing by ionizing radiation and for other dosimetry purposes. As witnessed by three recent sequential international symposia on ESR dosimetry (with a fourth scheduled for Munich in 1995) (20,32,58), the subject has proven to be broad and comprehensive. It covers not only high-dose dosimetry and standard measurement services for industrial processing applications (radiation sterilization of medical devices and pharmaceuticals and food irradiations), but also dosimetry review for radiation emergencies (e.g., Chernobyl), clinical dosimetry (e.g., teletherapy treatment planning), bone dosimetry in nuclear medicine, dating in archeology, geology, and paleontology, and radiation effects and imaging in a variety of materials (42). Figure 1 gives a chart of applications and systems now under investigation at the U.S. National Institute of Standards and Technology.

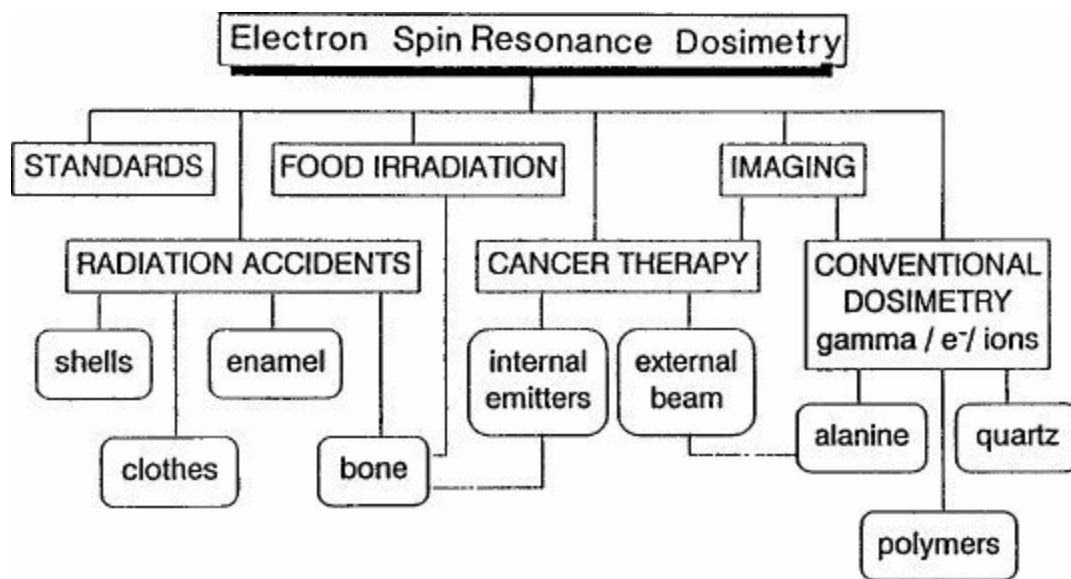

Figure 1. Applications and Examples of Systems for ESR Dosimetry Carried Out at the U.S. National Institute of Standards and Technology

One important reason for the burgeoning interest in this many-faceted approach to practical dosimetry is the very broad dynamic range that is achievable by ESR spectrometry, generally stated to be  $10^{-1}$  to  $10^8$  Gy (41).<sup>2</sup> Alanine/ESR dosimetry is one of the most important methods, having an operable dose range of  $10^0$ - $10^5$  Gy (56,57,59,71).

Successes have been demonstrated with alanine/ESR in several quarters: 1 ) the International Atomic Energy Agency's International Dose Assurance Service (IAEA's IDAS), first instituted jointly by the IAEA and the German Gesellschaft für Strahlen-und Umweltforschung (GSF) in 1985 (48,49,57); 2) the ESR alanine dosimeter reference service begun in 1991 at the U.K. National Physical Laboratory (NPL) in Teddington (61); and (3) similar measurement services administered by the Italian Istituto Superiore di Sanità (ISS) in Rome (59), by the French Laboratoire Primaire des Rayonnement Ionisants/Bureau National de Metrologie (LPRI/BNM) in Gif-sur-Yvette (62), and the Japan Atomic Energy Research Institute (JAERI) in Takesaki (36).

There are, however, four distinct limitations that have restricted its universal use by industry. These limitations have been: 1) the capital expense of the ESR spectrometer, which, until recently had a cost that was more than an order-of-magnitude greater than that of a conventional double-beam UV-visible spectrophotometer; 2) the lack of an easy-to-use ESR spectrometer that is dedicated to dosimetry; 3) the relatively high cost of individual dosimeter units; and 4) the absence of a supplier of mass-produced, widely-available, lower-cost, reproducible batches of dosimeters. It is encouraging that these four limitations are now being rectified, and the overall costs are approaching those of conventional systems (see Table I and Figure 2) (3,37,40). In fact, the wide acceptance and potentially greater market for alanine/ESR in a number of dosimetry applications is driving the cost of the dosimetry-dedicated ESR spectrometer down to the same level as that of the top-of-the-line UV-*vis* spectrophotometer (see Table I).

Table I. Estimated Dosimetry Costs (U.S. Dollars)

--	--	--

Type	Cost per Dosimetry (in bulk)	Cost per Reader
Fricke	2	10-30 k
Ceric Cerious ("Compu-Dose")	2	0.5-3 k
PMMA (Harwell)	0.7	10-30 k
RCD films (FWT)	0.13	2-30 k
RCD films (GAF)	0.05	2-30 k
Alanine	1 to 10	30-220 k

The details of the traditional ESR spectrometer are thoroughly described in the literature (2,40). It possesses an electromagnet equipped with a cavity that is usually operated in the microwave X-band with an external static magnetic field that is modulated at radio frequencies. The electron spin resonance absorption is measured by sweeping the external magnetic field strength over prescribed limits, depending on the paramagnetic properties of the test sample. Standardizing the ESR absorption intensities can be accomplished by measurement of a standard sample having a stable and relatively simple ESR signal (e.g., O<sub>2</sub>-depleted charcoal). The ESR analysis is generally carried out with the small dosimeter sample fitting into a quartz capillary tube (typical inner diameter ~0.5 cm), which is inserted at a fixed, repetitive position in the magnetic field (see Figure 3). Following the magnetic field sweep, the computerized console then stores and displays the relevant data, including the ESR absorption spectrum, usually as its first derivative (see Figure 4).



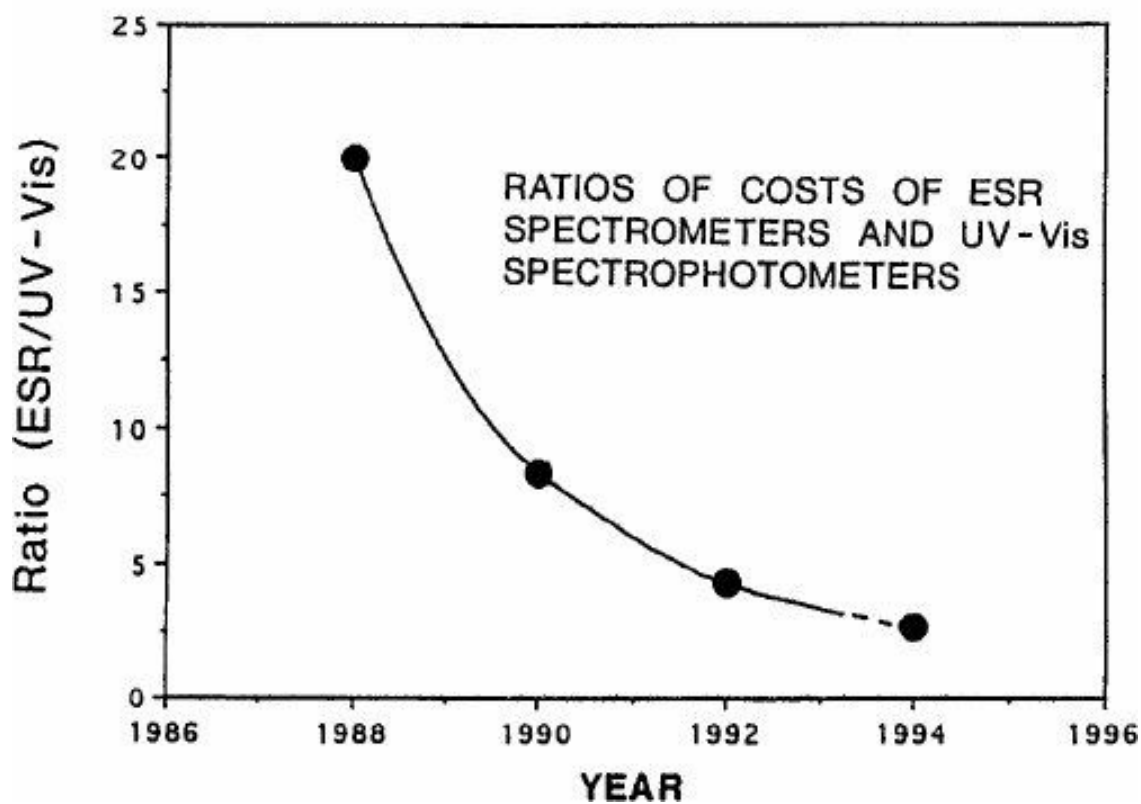
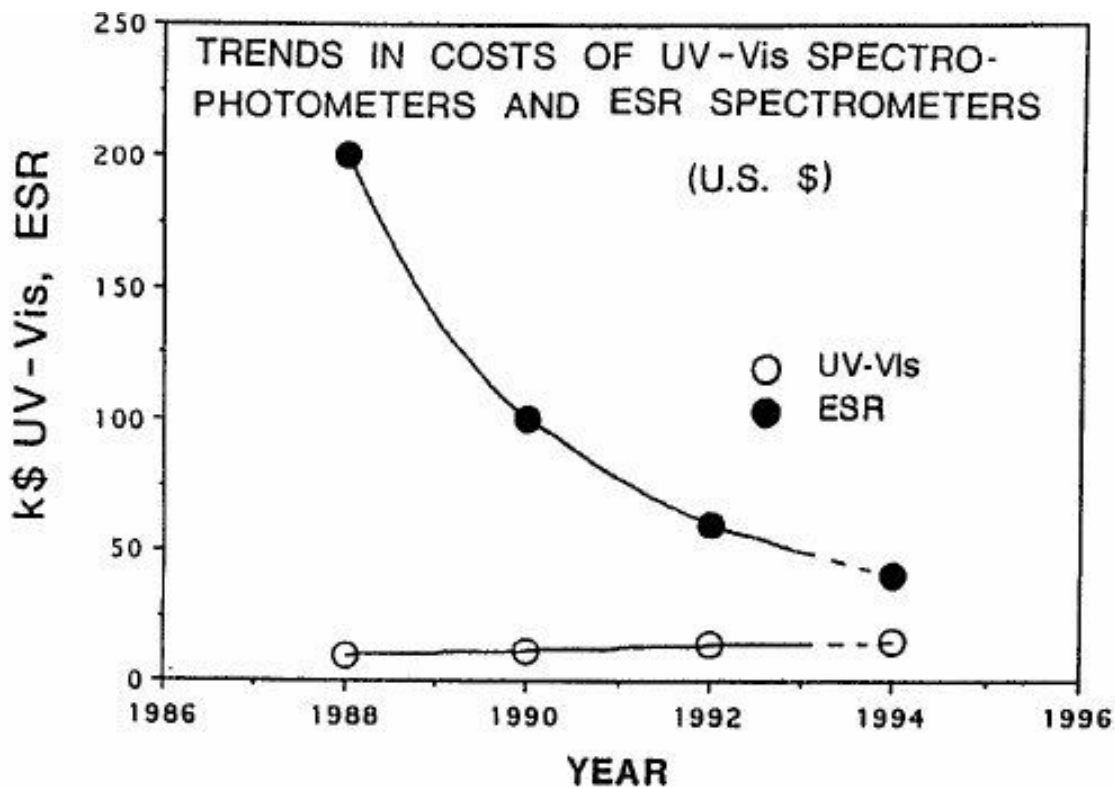

Figure 2. Cost Trends (top) Since 1988 for ESR Spectrometers and UV-Visible Spectrophotometers and Their Ratios (bottom)

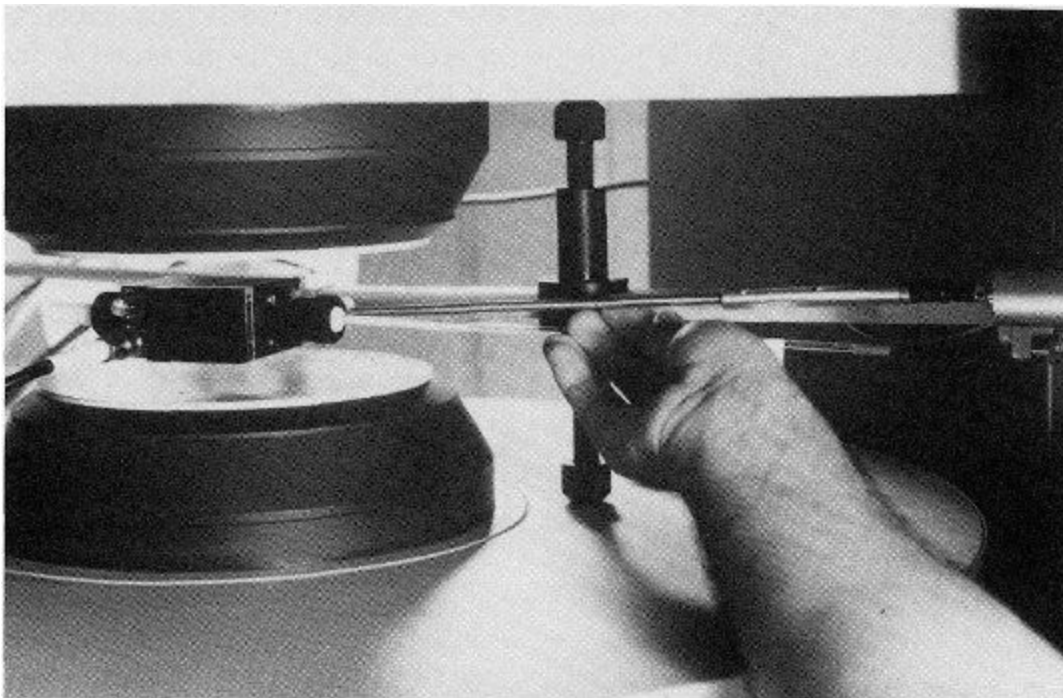

Figure 3. The Placement of a Quartz Sample Tube in the Microwave Cavity Between the Electromagnet Dipoles of the ESR Spectrometer

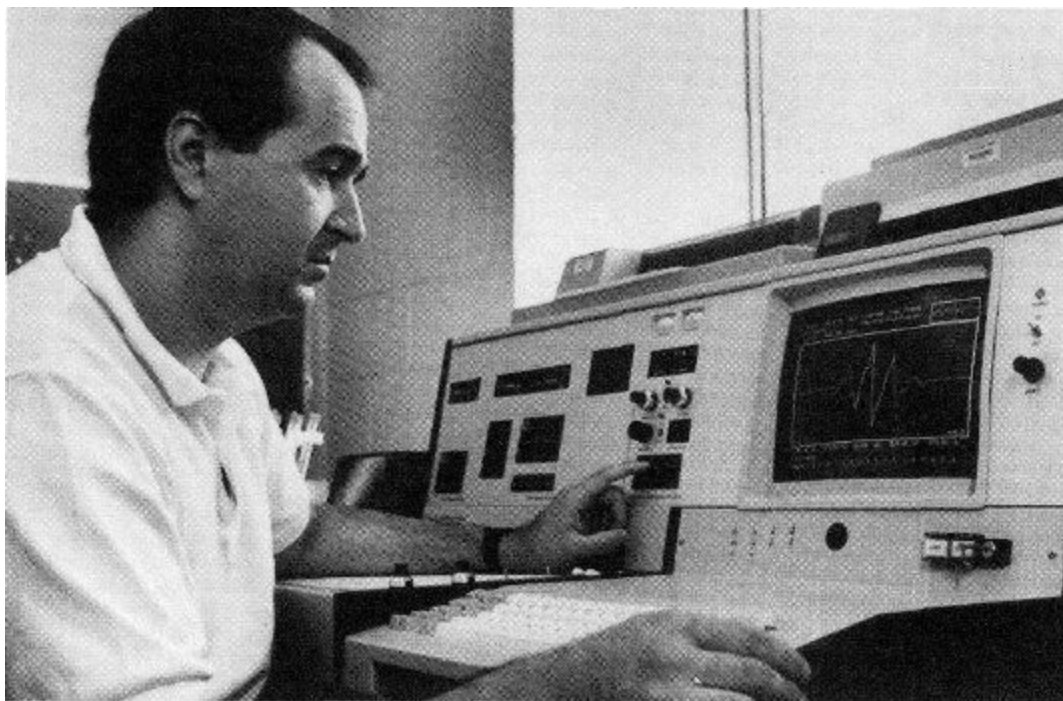
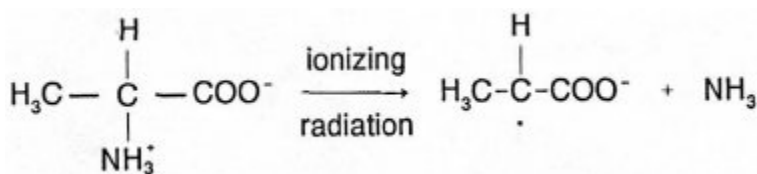

Figure 4. The Reading of an ESR Spectrum of an Alanine Sample at the Console of the Spectrometer

At present, the most commonly used ESR dosimeter is based on microcrystalline L- $\alpha$ -alanine,  $\text{CH}_3\text{CH}(\text{NH}_3^+)\text{CO}_2^-$ , which is usually held in a polymeric binder such as low molecular weight polyethylene or paraffin, polystyrene, or ethylene-propylene rubber. The mixture is made into a rod, pellet, or for some applications, a film (34,36) or cable (15), that can be cut into

convenient sizes (see Figure 5). The chemical reaction involves the radiation-induced deamination of the zwitterions into the radical anions (39):



which act as stable paramagnetic centers in the solid state.

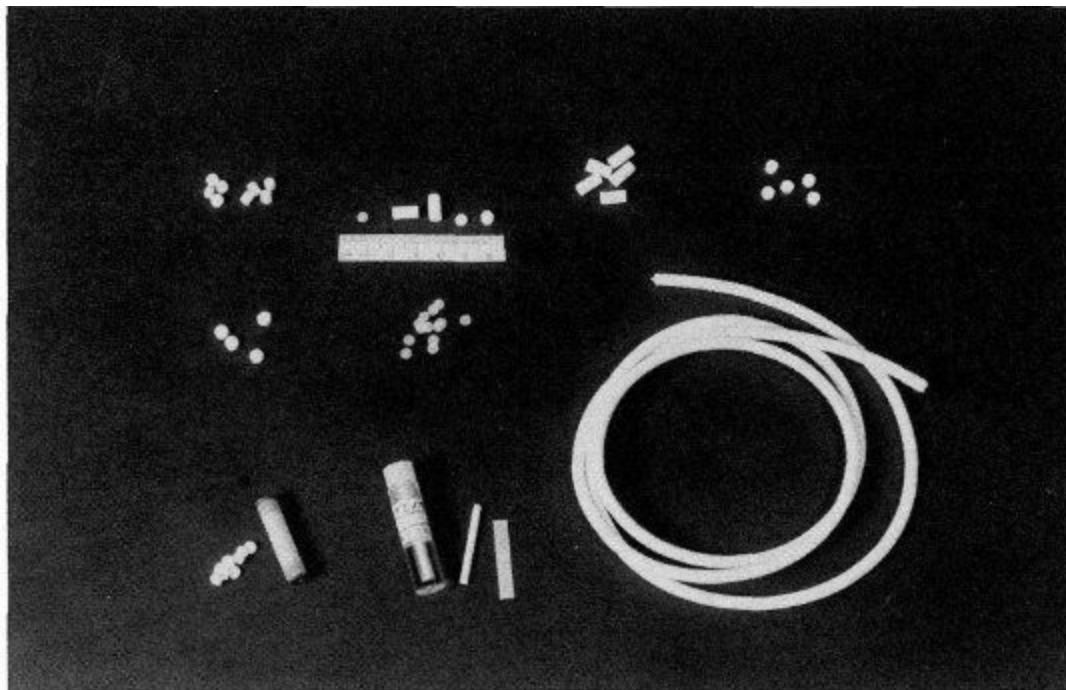

Figure 5. Examples of Different Kinds of Alanine/Polymer Dosimeters, Including Pellets, Rods, Film Pieces, and Cable

The primary aim of this paper is to review the status of alanine dosimetry, as well as the use of other suitable materials compatible with ESR analysis, for applications (especially those of radiation processing) over a broad range of absorbed doses. We shall also present a perspective for the future of this dosimetry method and its relevance for a variety of radiation processing applications. Paramount to our expectations are diminished costs, improved accuracy and precision, and the introduction of better, more widely available dosimeters and readout techniques (e.g., imaging of two- or three-dimensional dose distributions).

# Basis of ESR for Dosimetry

Upon irradiation of the amino acid, L- $\alpha$ -alanine, or other materials (e.g., sugars, silica, certain polymers), stable free radicals may be created. These radicals are in the form of paramagnetic centers<sup>3</sup> consisting in this case of unpaired electrons that are trapped, for example, by impurities or crystalline matrices. This population of stable centers is usually proportional to the absorbed dose. The medium is then placed in the ESR spectrometer cavity and subjected to the strong, swept magnetic field. The sample cavity is operated at microwave frequencies (using the X-band at a fixed frequency within the range 9 to 10 GHz) with a perpendicular external static field modulated at a certain radiofrequency (RF) usually between 50 to 100 kHz. In this crossed magnetic field, the medium undergoes microwave absorption that is characteristic of the particular gyromagnetic properties of interactions between the processing magnetic movement of the electron spin and the surrounding molecular system. This absorption is measured usually by a silicon-based Schottky diode detector acting as a microwave rectifier, and, for most dosimetry applications, is registered as its first derivative (see Figure 6).

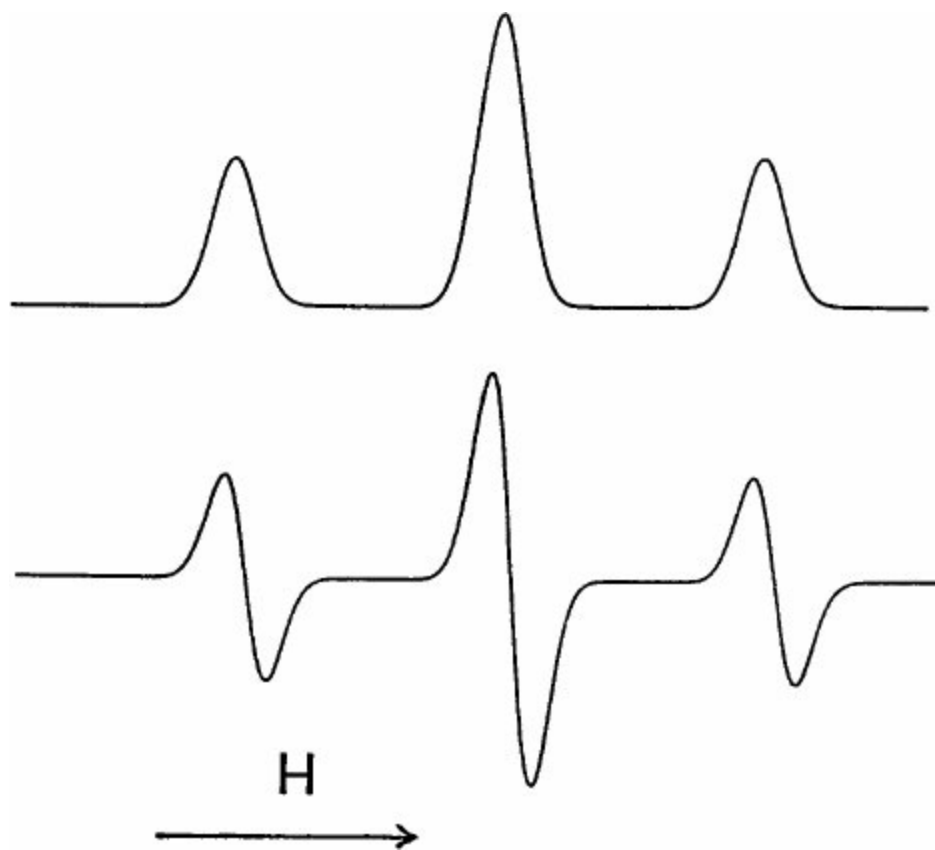

Figure 6. Examples of a Simple ESR Absorption Spectrum (top) and Its First Derivative (bottom)

As illustrated in Figure 7, the splitting of the electron spin states allows permitted magnetic dipole transitions (2), which the unpaired electron spin system experiences in the crossed steady (H) and RF ( $H_1$ ) magnetic fields as a splitting of Zeeman energy states ( $M_g = +\frac{1}{2}$  and  $-\frac{1}{2}$ ). The line energy absorption is such that the following resonance condition is satisfied for the energy level separation,  $\Delta E$ :

$$\Delta E = h\nu = g\mu_{\beta} H$$

where  $h$  is Planck's constant,  $\nu$  is a selected frequency giving a certain paramagnetic absorption,  $g$  is the dimensionless Landé spectroscopic splitting factor,  $\mu_{\beta}$  is the constant Bohr magneton ( $\mu_{\beta} = 9.2741 \times 10^{-22} \text{ J T}^{-1}$ ), and  $H$  is the swept magnetic field strength in tesla (T).<sup>4</sup> The value of  $g$  is typically about 2, and for the free electron  $g_e = 2.00232$ . The first-derivative spectral amplitude of the main peak-to-peak spread is proportional to the concentration of paramagnetic species, and the absorption spectral shape and the resonant region in the swept field depend on the hyperfine coupling between the unpaired electron and the magnetic moment of the surrounding nuclei. For ESR dosimetry readings, the choice of the magnetic sweep depends on the kind of paramagnetic center being observed and on its molecular environment; for example, the amino acid, alanine, at room temperature, may require a 20-mT full sweep, while the radiation-induced  $E'$  center in quartz ( $\text{SiO}_2$ ) is encompassed by a 0.2-mT sweep.

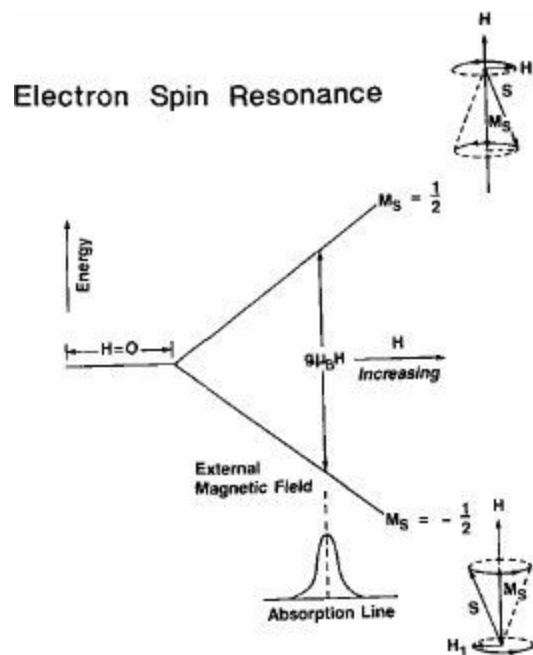

Figure 7. Energy Level Diagram Showing Zeeman Splitting for a Simple Free Electron Spin System in Crossed Steady ( $H$ ) and Radiofrequency ( $H_1$ ) Magnetic Fields (2)

Table II. ESR Dosimetry Systems (Organic)

Dosimetry Material	Binder Material	Form	Dose Range $\rho$ (Gy)	Sample Reference
L- $\alpha$ -alanine ( $\text{C}_3\text{H}_7\text{NO}_2$ )	polymer (e.g., paraffin)	rods, pellets, films	$10^0$ – $10^5$	56
D- $\alpha$ -sucrose ( $\text{C}_{12}\text{H}_{22}\text{O}_{11}$ )	polymer (e.g., paraffin)	rods, pellets, powder	$10^{-1}$ – $10^4$	4
	polymer (e.g.,	rods, pellets,		

D- $\alpha$ -lactose ( $C_{12}H_{22}O_{11} \cdot H_2O$ )	paraffin)	powder	$10^2-10^6$	53
methyl viologen ( $C_{12}H_{14}N_2$ )	polymer (e.g., polyvinyl alcohol)	films	$10^2-3 \times 10^5$	50
tris(hydroxymethyl aminomethane ( $C_4H_{11}NO_3$ )	—	pellets, powder	$5-10^4$	53
cellulose ( $C_{12}H_{20}O_{10}$ ) <sub>n</sub>	—	wafers, films	$10^3-5 \times 10^5$	70
triphenylmethane dyes ( $C_{20}H_{18}N_4$ ) <sub>n</sub>	polymer (e.g., polyvinyl butyral)	films	$10^3-10^5$	68
polyvinyl alcohol ( $C_2H_4O$ ) <sub>n</sub>	—	films, powder	$10-10^5$	21
polytetrafluoroethylene ( $C_2F_4$ ) <sub>n</sub>	—	rods, films, powder	$10^2-10^5$	35

# Dosimetry Systems

Many solid materials show relatively stable paramagnetic properties when subjected to ionizing radiation. Tables II and III list, respectively, organic and inorganic materials, their usual form for dosimetry, typical dose ranges, and a sample reference for each. It can be seen from these listings that a very wide absorbed dose range can indeed be measured ( $10^{-1}$ - $10^8$  Gy) by ESR analysis.

**Table III. ESR Dosimetry Systems (Inorganic)**

Dosimeter Material	Form	Dose Range (Gy)	Sample Reference
quartz ( $\text{SiO}_2$ )	glass, powder	$10^4$ - $10^8$	69
magnesium orthosilicate ( $\text{Mg}_2\text{SiO}_4\text{:Tb}$ )	powder	$5$ - $3 \times 10^3$	8
magnesium sulfate ( $\text{Mg SO}_4$ )	powder	$10^0$ - $10^5$	45
lithium fluoride ( $\text{UF:Mg,Tl}$ )	powder	$10^0$ - $10^5$	23
bone, hydroxyapatite ( $\text{Ca}_{10}(\text{OH})_2(\text{PO}_4)_6$ )	powder, solid pieces	$10^0$ - $10^4$	63
dental enamel, hydroxyapatite ( $\text{Ca}_{10}(\text{OH})_2(\text{PO}_4)_6$ )	powder, solid pieces	$10^{-1}$ - $10^4$	1,54

The radiation-induced first-derivative ESR spectra, with values of the g-factor centered at absorption bands where the ESR peak-to-peak signal can be measured for dosimetry is shown for the amino acid, L- $\alpha$ -alanine and the sugar, D-lactose, in Figure 8 and for the polymer, cellulose, and crystalline quartz ( $\text{SiO}_2$ ), in Figure 9. On the right side of Figures 8 and 9 are the dosimetry response curves in terms of the ESR signal amplitude as a function of dose. These response functions illustrate the broad dose range of ESR analysis for passive dosimetry. The relatively broad response for the alanine/ESR system is illustrated in Figure 10, where typical dose ranges for several high-dose dosimeters are charted. It should be pointed out that the alanine/ESR system can provide measurements of doses covering not only those in the sterilization range ( $10^4$ - $5 \times 10^4$  Gy), but also a dose region where precise and accurate dosimetry is especially needed, namely where both food irradiation and validation and dose-setting studies are made ( $5 \times 10^2$  -  $10^4$  Gy). The reproducibility of alanine dosimetry has been reported by the NPL "Alanine Dosimeter Reference Service" in terms of a random uncertainty of  $< \pm 1.2\%$  (at 95% confidence level), with an overall uncertainty of  $< \pm 3.0\%$  (at 95% confidence level), for doses in the range  $10^2$  -  $4 \times 10^4$  Gy (61). It has also been shown by Janovsk (34) that alanine film using polyethylene (vinyl acetate) as a binder covers the dose range up to  $10^5$  Gy (see Figure 11), with no variation between the response to gamma rays and electrons.

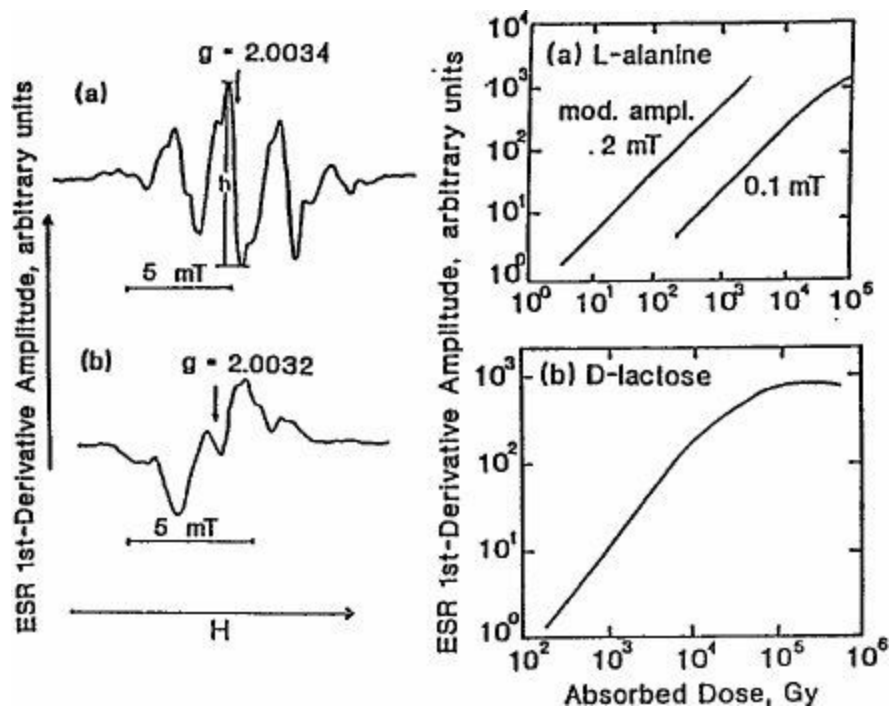

Figure 8. (Left) ESR First-Derivative Spectrum of Irradiated L-alanine (top) (The amplitude  $h$  is the usual measurement for dosimetry, which is a function of the absorbed dose) and D-lactose (bottom); (Right) Log-Log Plots of the Relative ESR Signal ( $h$ ) Versus the Absorbed Dose (41)

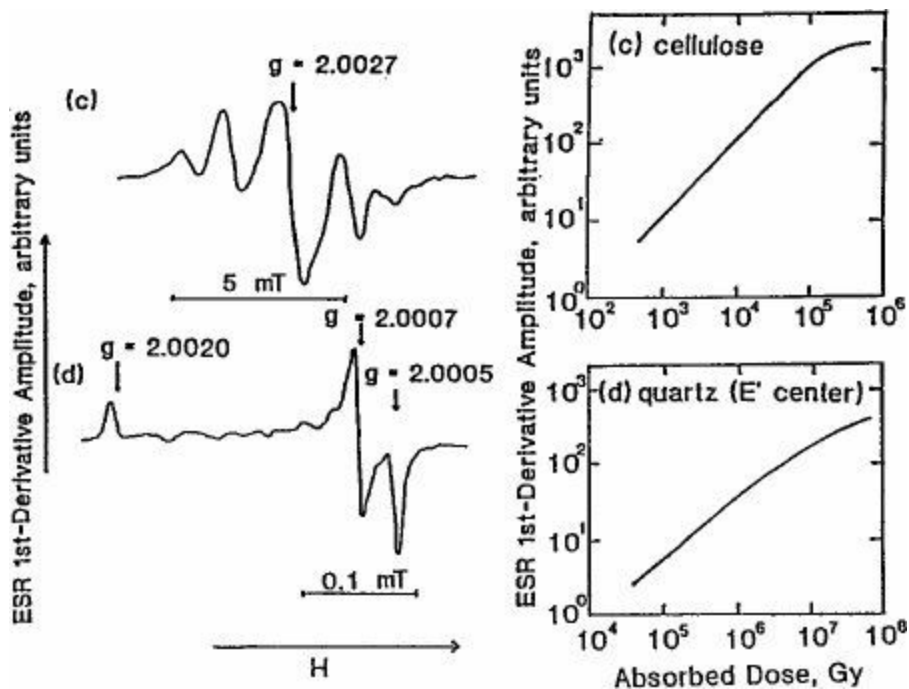

Figure 9. (Left) ESR First-Derivative Spectrum of Cellulose (top) and Quartz (bottom); (Right) Log-Log Plots of the Relative ESR Signal ( $h$ ) Versus the Absorbed Dose (41)



## Dosimetry Systems Gamma and X-ray

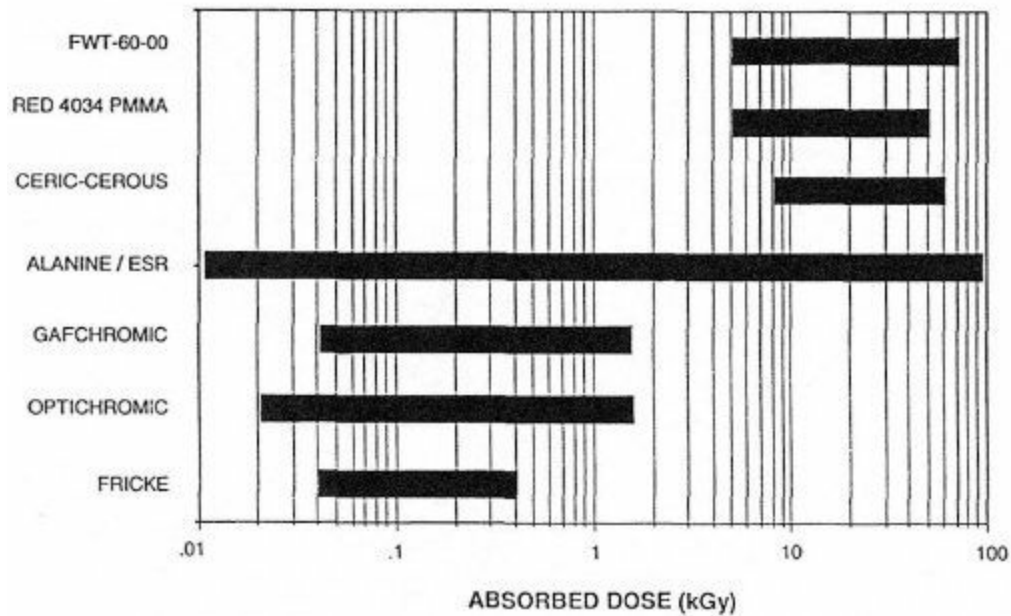

Figure 10. The broad dynamic absorbed dose range for alanine/ESR as compared with ranges for some other routine and transfer standard dosimetry systems commonly applied to medical device and food irradiation.

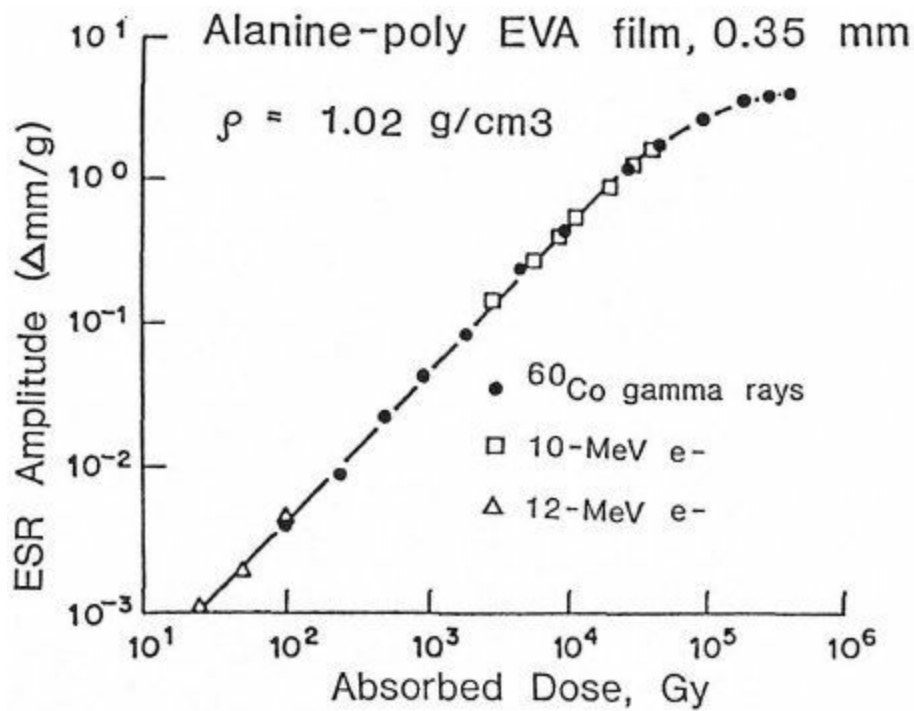

Figure 11. Response curve for a 0.35-mm thick alanine dosimeter using polyethylene-vinyl acetate as a binder (34). The film was irradiated over the dose range  $2 \times 10^1 - 5 \times 10^6$  Gy using gamma rays and electrons as indicated.

As will be discussed later, bone, tooth enamel, and skeletal tissue may also be used for dosimetry in several applications, including the detection of certain irradiated foods, nuclear

medicine studies, and the dating of paleontological organic samples (20,32,58). The broad range covered by ESR analysis of the hydroxyapatite component of such tissues, compared with that for alanine, is illustrated in Figure 12, for several important applications.

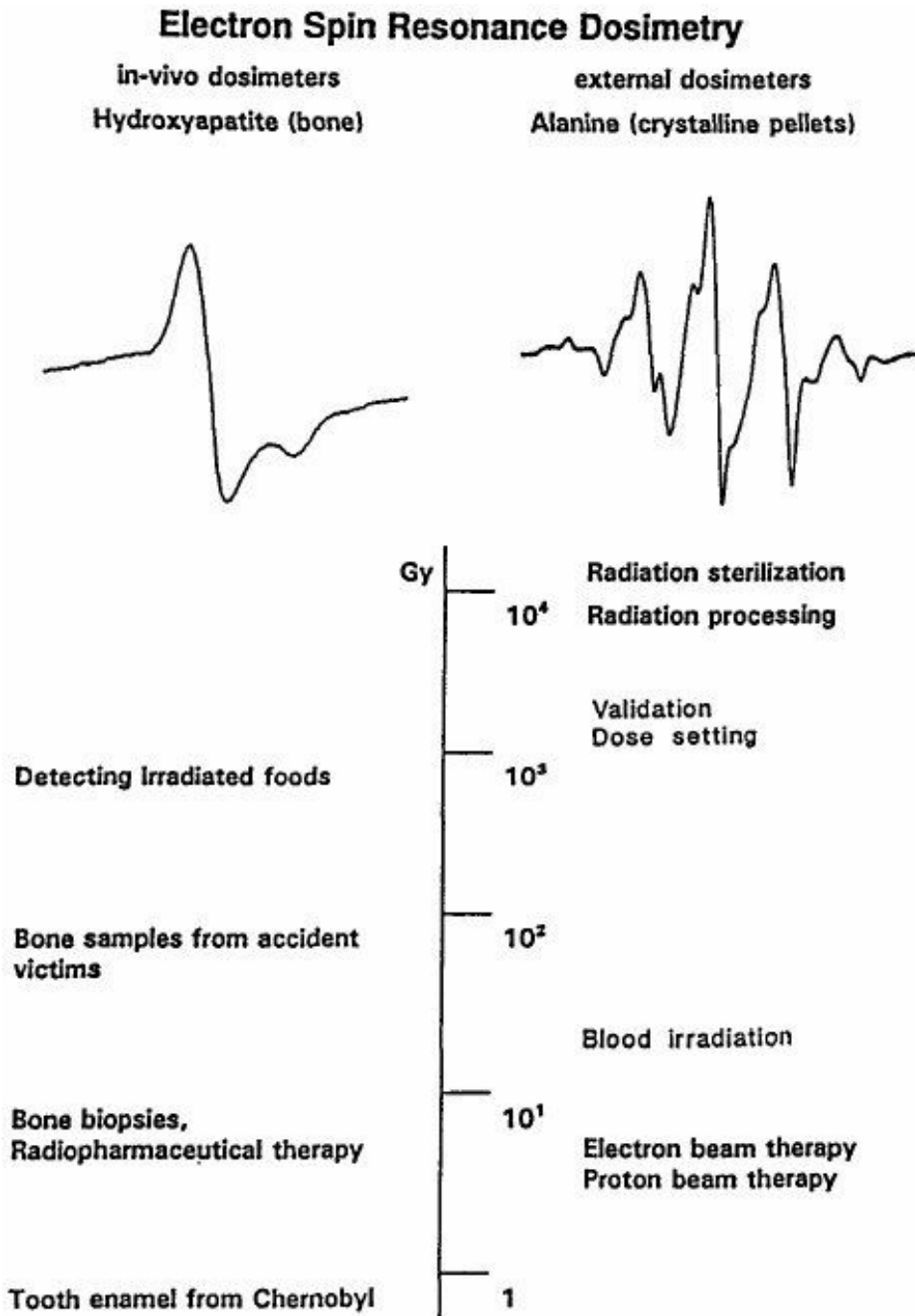

Figure 12. Examples of ESR Spectra for Bone and Alanine Dosimeters and Examples of Applications Over an Absorbed Dose Range 1 to  $> 10^4$  Gy.

# Alanine/ESR in Reference and Transfer Dosimetry

The main characteristics of alanine dosimetry systems are summarized in Table IV. For purposes of radiation processing dosimetry, some relevant properties that make alanine/ESR systems suitable for reference dosimetry and for interlaboratory transfer radiation measurements, considering the long delay times and different environmental conditions, are outlined in Table V.

**Table IV. Alanine/ESR**

- 
- Dose range  $10^0 - 10^6$  Gy
  - Long-term stability (years)
  - Non-destructive analysis
  - No read-out treatment
  - High accuracy and precision
  - Different geometries with a binder (pellets, rods, films, cables)
  - Inexpensive materials
  - Near-tissue-equivalence
  - Relatively insensitive to ambient parameters  
(optimum conditions of storage:  $50\% \pm 10\%$  r.h.)
- 

**Table V. Alanine/ESR — Key Properties for Long-Term Dosimetry (At High Doses)**

- 
- Pre- and post-irradiation stability (permanent radiation effect, no rate dependence)
  - Slight temperature dependence
  - Slight photosensitivity
  - Slight atmospheric effects (moisture, reactive gases, e.g.,  $O_2$ , ozone)
  - Inexpensive in large quantities, rugged, reproducible
  - Large dynamic range (dose, dose rate)
  - Easily calibrated
- 

It was on the basis of these advantages that alanine/ESR dosimetry, as performed at GSF/Munich, was first selected as the IAEA International Dose Assurance Service system (48,49,57,59). This service by the IAEA is now operated as a mailed dosimetry evaluation procedure by the IAEA Seibersdorf Dosimetry Laboratory, and is presently extended to 31 institutes from 22 Member States. Calibrated alanine dosimeters are mailed, at Member State request, primarily to industrial and pilot-scale facilities, where they are irradiated along with reference or routine in-house dosimeters to doses in the range of  $10^1-10^5$  Gy. They are then returned to Seibersdorf and are evaluated, so that the measured dose can be compared to the nominal dose administered at the radiation facility. Since 1985 results have shown improved precision and accuracy of the evaluation of industrial radiation processing doses, as long as suitable care is given to controlling the geometry of dose delivery and monitoring of the

temperature during irradiation is reported back to the dosimeter-issuing laboratory (42,48).

There are now attempts being made to develop alanine/ESR dosimetry for therapy level doses ( $10^1$ – $10^2$  Gy) (25,71). The question has even been asked as to whether this system, because of its key properties (see Table V), might replace the venerable Fricke dosimeter for clinical applications (25).

For such use at doses  $< 10$  Gy, the main limitation for accurate dose assessment is the influence of the background signal in the region of the magnetic field where ESR absorption measurement is made. Figure 13 shows typical ESR spectra of unirradiated alanine/paraffin samples from five different batches, showing on the right the differences in apparent dose reading due to background signals (71). Because of this effect at low doses, it is necessary to use an empirical method of subtraction of this apparent dose (see Figure 14), which represents a significant effect at the therapy dose levels (71). Dosimeter manufacturing procedures are currently under development to minimize this background signal variability.

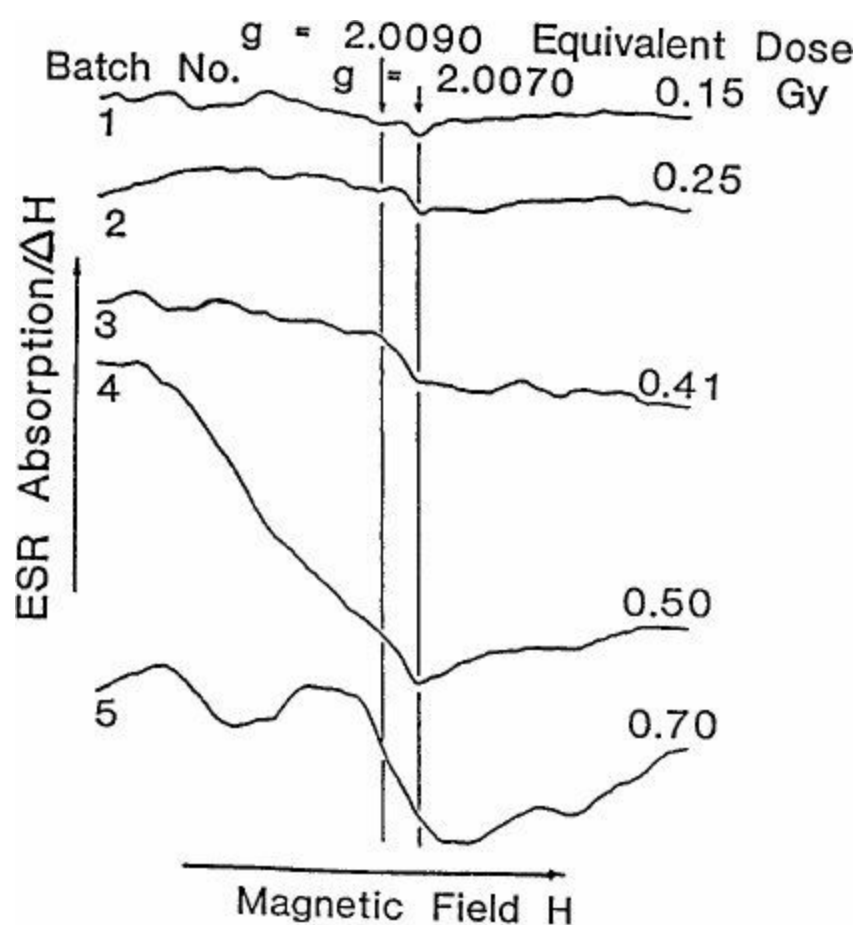

Figure 13. Examples of ESR spectra (total magnetic field scan 20 mT) of unirradiated alanine/paraffin dosimeters from different batches produced in the same laboratory (71). The right-hand numbers indicate the “artefact” equivalent doses represented by the amplitudes of these background spectra.

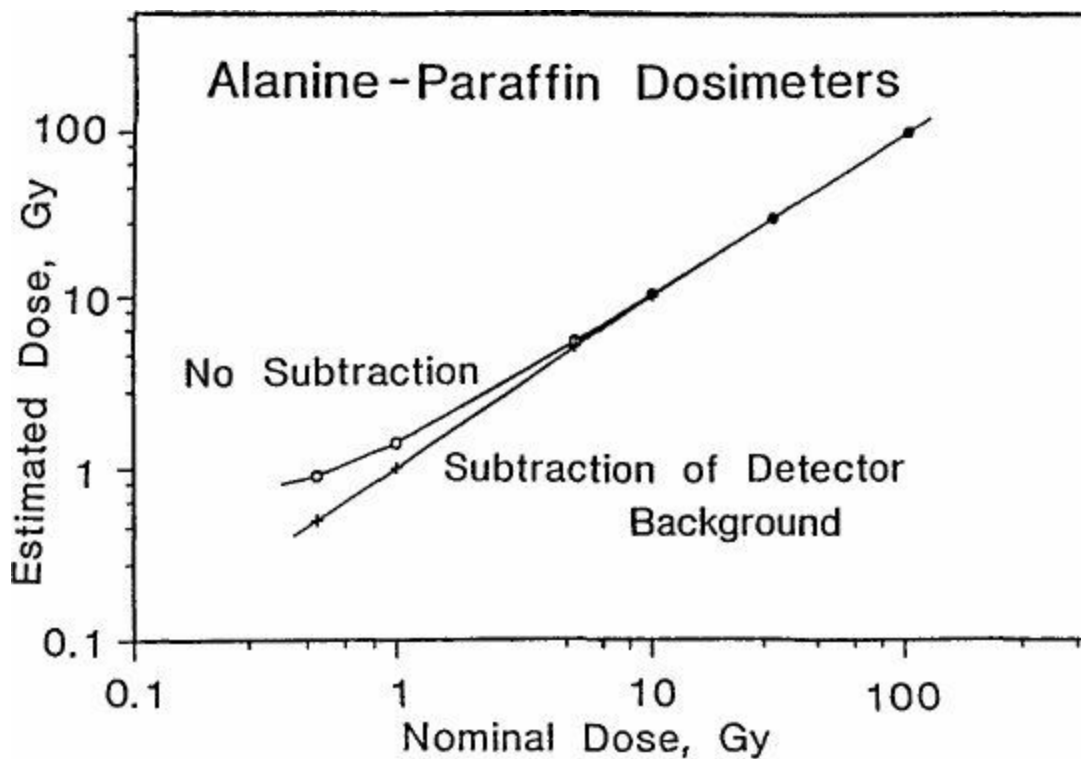

Figure 14. Estimated dose registered by reading irradiated alanine/paraffin dosimeters, as a function of the nominal dose, with and without correction for the kind of background spectral amplitude illustrated in Figure 12 (71). The corrected response (linear log-log function) is normalized according to the calibration at a dose of 1 kGy.

Another concern is the general perception that alanine is “tissue-” or “water-equivalent” in its radiation response characteristics (see Table IV). Figure 15 shows ratios of photon energy absorption coefficients ( $\mu_{en}$ ) and electron collision stopping powers ( $S_{coll}$ ), alanine-to-water (52). These calculations reveal that absorbed dose in alanine for typical irradiations by ionizing photons and electrons would have values three or four percent lower than the absorbed dose in water. However, when the calibration is made in terms of absorbed dose in water, corrections are required only if the practical irradiations requiring dose measurement (photons or electrons) encounter materials having significantly different absorption properties from those involved in the calibration (41).

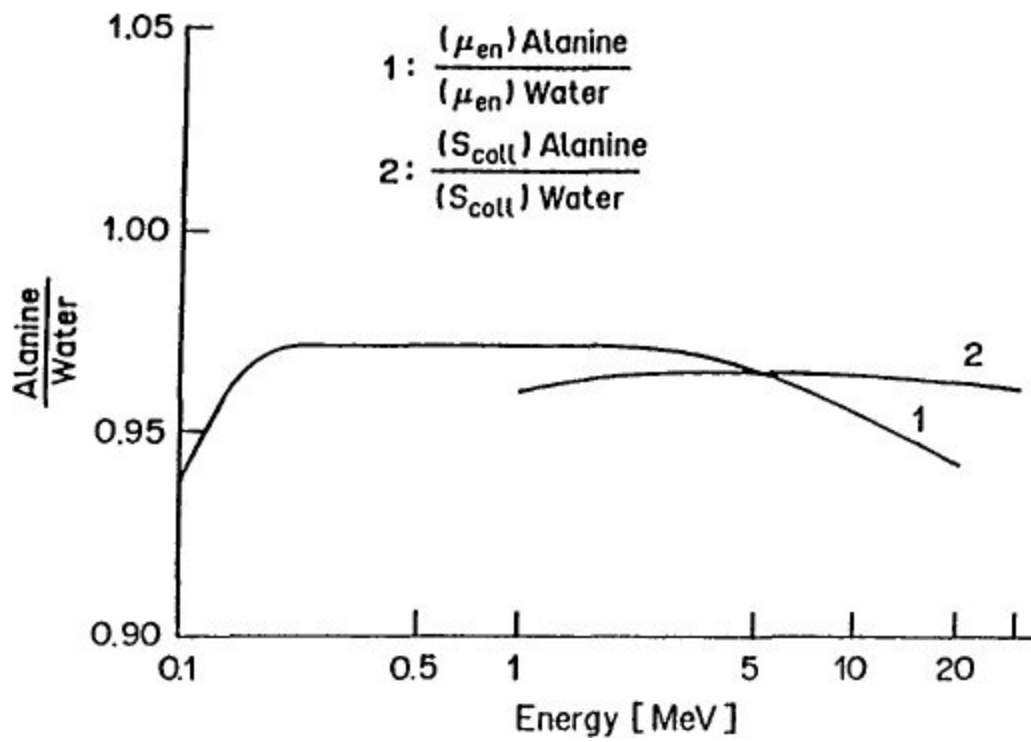

Figure 15. For the spectral regions indicated: Curve 1, ratio of calculated mass energy-absorption coefficients for alanine and water; Curve 2, ratio of calculated mass collision stopping power for alanine and water.

# Bone and Tooth Dosimetry

Another broad use of ESR spectrometry for dosimetry involves ESR measurement of irradiated bone or tooth enamel. Applications include the detection and the dose assessment of certain irradiated foods (fish, shell fish, and meats containing bone) (16,17,18,43,55,64), investigations of dose to residents near the Chernobyl reactor (33), measurements of dose to bone in nuclear medicine (19), and the dating of prehistoric human and animal (e.g., mammoth) skulls, their fossils, and of shells from 1000 years to 10 million years old (13,20,26). These specimens have been exposed over millennia to natural background radiation, and, upon further irradiation in the laboratory to a series of known doses, a careful curve fitting allows extrapolation to the time at which exposure to natural radiation began (27). In fact, ESR dating using radiation-induced E' centers in quartz has been successful with samples that are orders-of-magnitude older than carbonaceous samples that can be dated back to about 60,000 years by radiocarbon dating, namely geological specimens older than one billion years (26,31).

Bone and tooth dosimetry methods are made possible because of the radiation-sensitive and highly stable ESR signal induced in the radical carbonate ion,  $\text{CO}_3^{\cdot-}$ , present in irradiated hydroxyapatite. Figure 16 shows the radiation-induced ESR spectrum of a beagle bone following radiotherapy treatment by internally administering short-range  $\beta$  radiation from the radionuclide  $^{166}\text{Ho}$  (19). A typical ESR spectrum due to the hydroxyapatite center in bone is seen in Figure 17, for a chicken bone irradiated with  $^{60}\text{Co}$  gamma radiation (18). The ESR technique for the detection of irradiated foods is illustrated in Figure 18, and is similar to the use of the standard addition of laboratory doses applied in ESR dating (18). In this example, frog leg bones from two different locations were given the same unknown dose, and after laboratory doses and an exponential least-squares curve fit (17,18) had been applied, the unknown dose of 1 kGy could be identified.

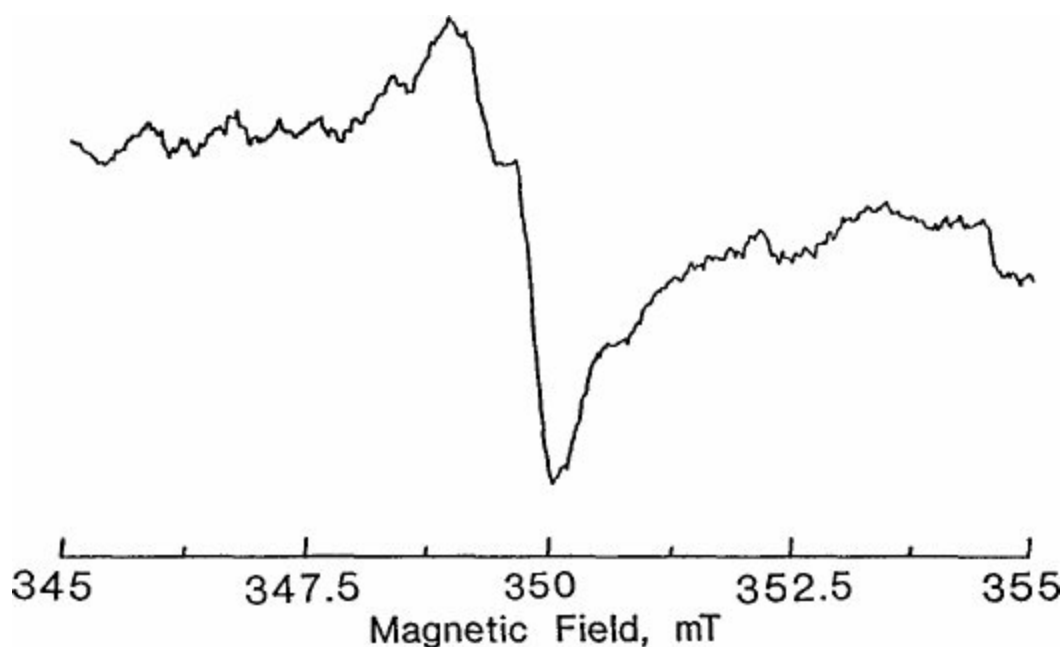

Figure 16. The ESR first-derivative spectrum for a fragment of a humerus cortical bone midshaft from a beagle that had been treated by  $^{166}\text{Ho}$  radiotherapy (a low energy  $\beta$ -ray emitter) (19). The estimated dose (measured at 349 mT) is 6 Gy.

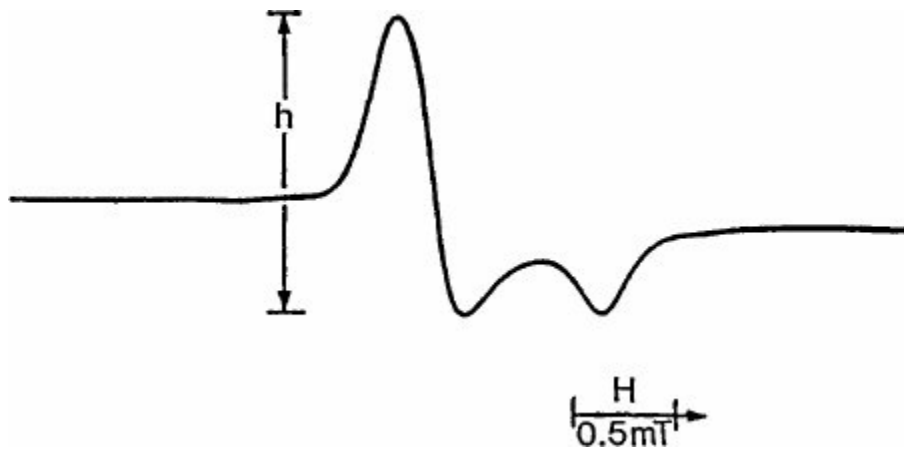

Figure 17. The ESR first-derivative spectrum of a chicken bone irradiated by  $^{60}\text{Co}$  gamma radiation (18). Detection of irradiated meat containing bone and evaluation of the dose depend on the functional relationship between the peak-to-peak amplitude,  $h$ , and the absorbed dose, established by administering a series of post-irradiation doses.



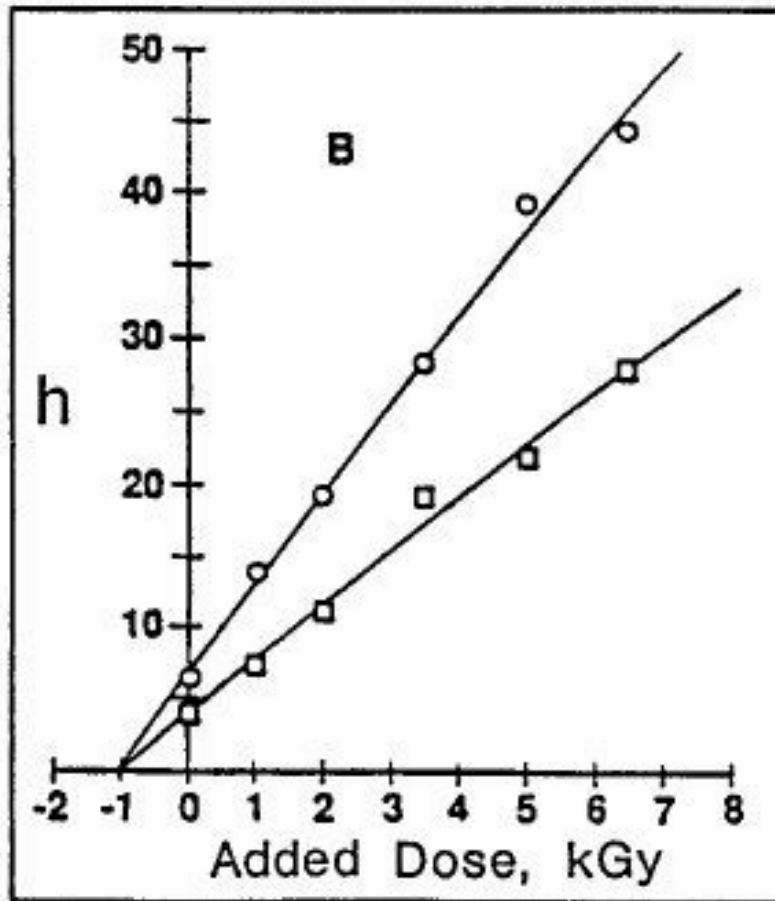
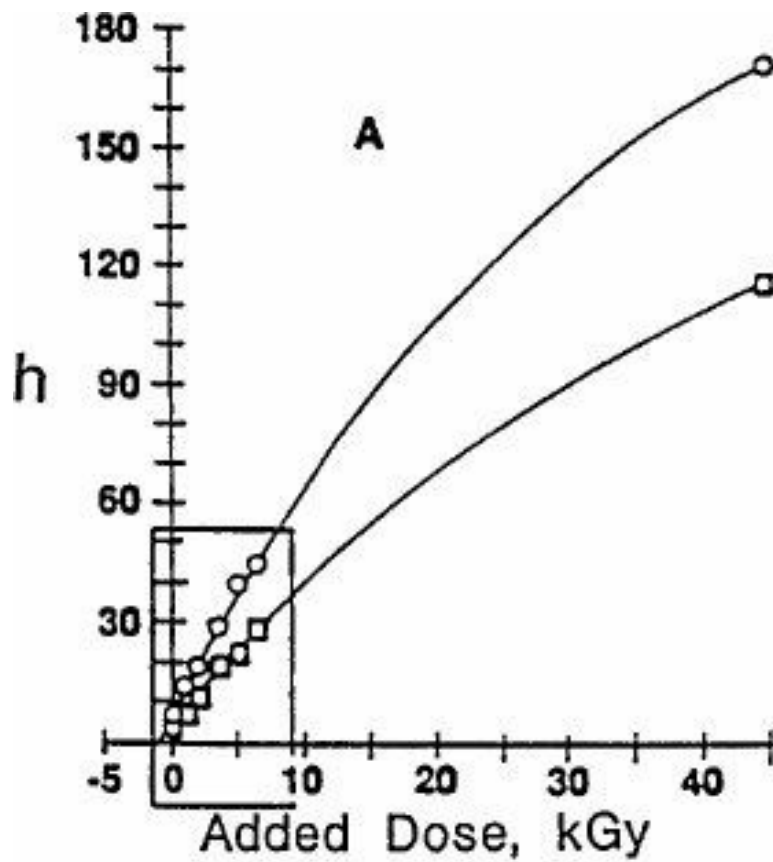

Figure 18. Plots of ESR peak-to-peak amplitude,  $h$ , as a function of added dose, for gamma-ray irradiated frog bones (18). The two curves are for two different frog bones given the same initial dose, which is estimated by exponential least-square curve fits to be 1 kGy. The curves in plot B are the enlargements of the boxed area in plot A.

# Sugar/ESR Dosimetry

Ordinary granulated sugar (sucrose) has been proposed for use as an emergency dosimeter (67). In fact, post-accident measurements have been made in the dose range of 0.05-40 Gy from household sugar collected from apartments at different sites near the Chernobyl reactor episode that took place on April 26, 1986 (46,47). This is one of the most sensitive ESR dosimetry systems, and yet one that has a wide dynamic range up to the usual sterilization doses. Figure 19 shows, for a sucrose/paraffin sample, the ESR spectral signal induced by an electron dose of  $2.8 \times 10^4$  Gy (44). For granulated sugar the response curve shape displays a linear response function between the ESR signal and dose at the lower dose range (see Figure 20). The radiation-induced signal is so stable that the use of sugar pellets may be proposed for broad-range routine dosimetry (66,67). However, some caution should be taken; recent investigations have found that sucrose dosimeter fabrication techniques (e.g., grinding and pressing) may produce free-radical ESR signals identical to the radiation-induced signal (24).

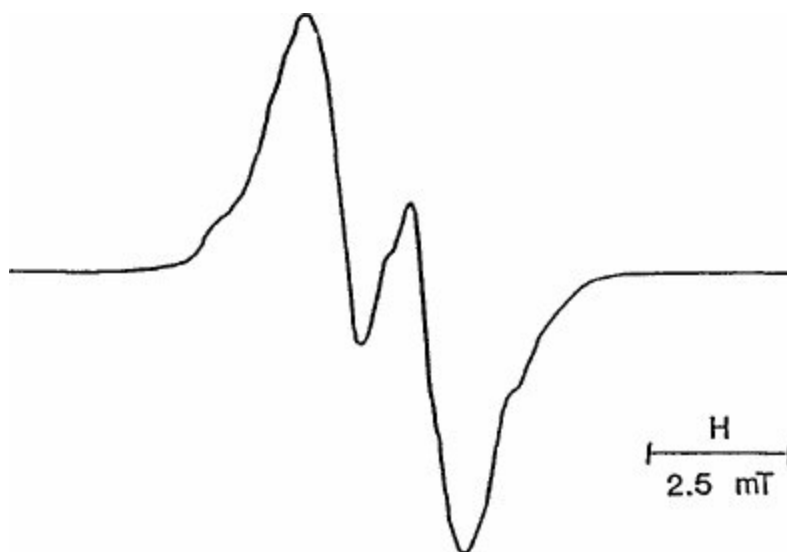

Figure 19. The ESR First-Derivative Spectrum for a Sucrose/Paraffin Sample Irradiated With Electrons From a 4-MeV Accelerator to an Absorbed Dose of  $2.8 \times 10^4$  Gy (44)

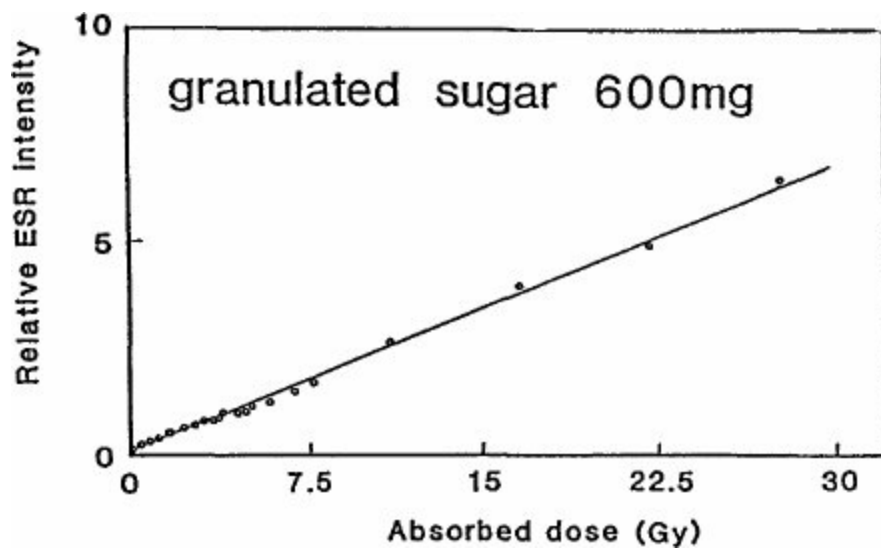

Figure 20. The Response Curve for a 600-mg Sample of Granulated Sugar (Sucrose) Irradiated By  $^{60}\text{Co}$  Gamma Radiation (46)

# ESR Imaging

The imaging of radiation dose distributions in two and three dimensions by ESR techniques has recently achieved relatively high spatial resolution (22,38,65). The method is similar to nuclear magnetic resonance imaging in that it combines the magnetic field gradients with spectral scanning over spatial ranges along the different spatial axes. The spectral-spatial scanning can be accomplished in either the X- (65) or L-band (38). It generally requires, however, customized controls of magnetic field, frequency, and amplitude modulation, and adaptation of the geometric arrangement in the spectrometer cavity, as well as added sets of gradient coils to generate sustained field gradients in two or three dimensions. This type of imaging also puts extra demands on spectral resolution (line width and its relation to the ESR signal) and the maximizing of field sensitivity for optimizing ESR signal-to-noise through signal averaging.

Profiles of radical concentration with depth due to electron-beam depth-dose penetration have been measured in this way in an alanine-paraffin block or rod dosimeter, and the resulting ESR absorption spectral-spatial images generated (14,44). Figure 21 (top) shows the experimental depth-dose (solid curve) for a degraded spectrum of 4-MeV electrons incident on the end of a 10-mm long dosimeter block along with the calculated depth-dose (dashed curve) for monoenergetic 4-MeV electrons incident on a semi-infinite material (44). At the bottom of the figure is a spectral-spatial 2-D image, where the ESR signal intensity is vertical (z axis), the depth-dose profile goes from back-to-front (y axis), and the magnetic sweep from left-to-right (x axis). For 2-D spatial imaging, another method is to use multiple sweeps and, by changing slightly the field direction for each sweep in the x-y dimensional plane of the test object, signal deconvolution can be made for all projections (29,30). This computerized tomographic method using multiple projections gives 2-D ESR images such as that shown in Figure 22 for a quartz glass tube irradiated by an isotropic field of  $^{60}\text{Co}$  gamma radiation (73). Relatively high spatial resolution in two and three dimensions can now be generated in a number of irradiated substances, such as alanine dosimeters or bone samples (29,30,38,44).

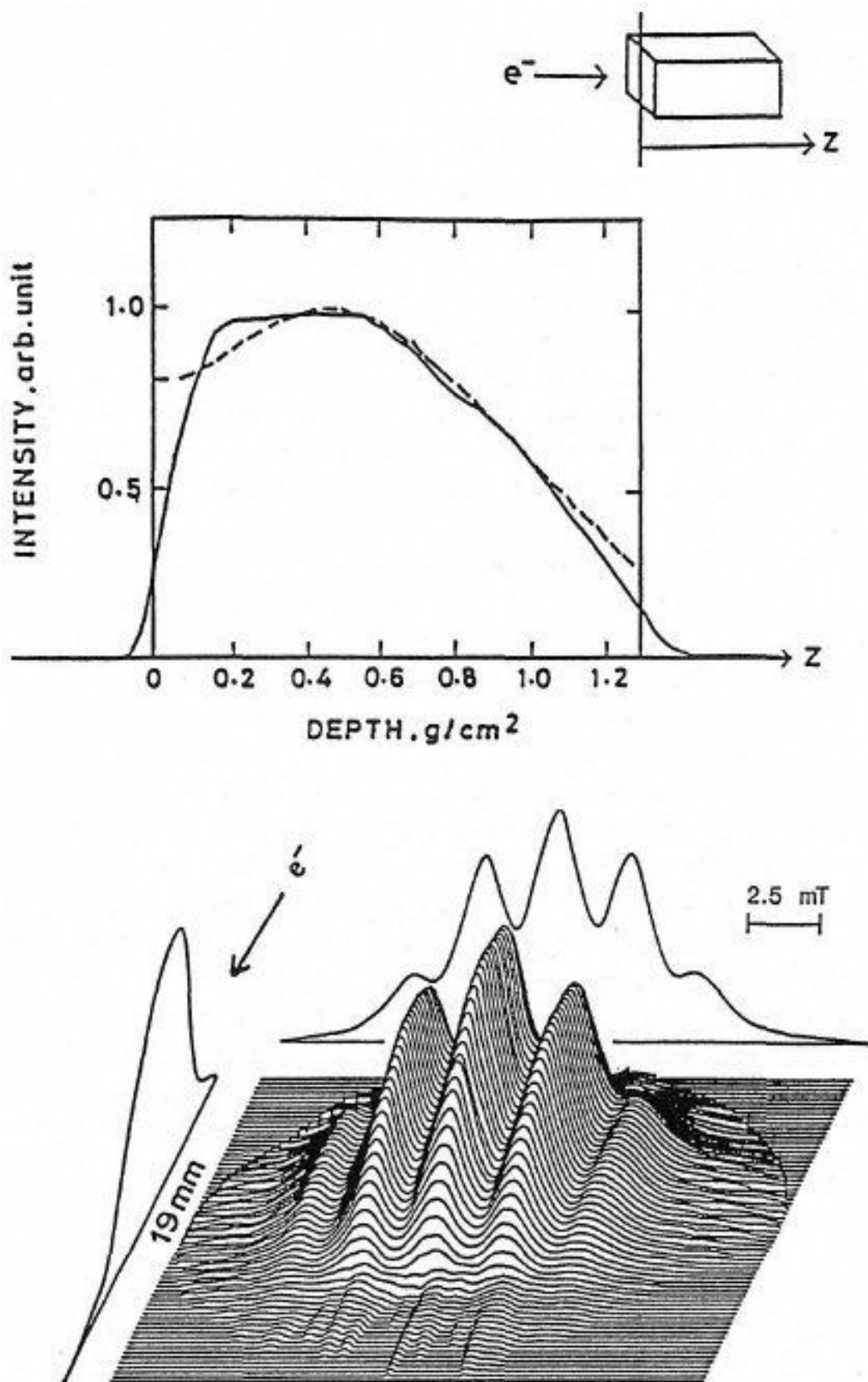

Figure 21. (Top) Calculated (dashed curve) and ESR-measured (solid curve) depth-dose profile for a 4-MeV electron beam incident from the left on a dosimeter block of alanine/paraffin (upper right inset) (44); (Bottom) the spectral-spatial image of the ESR absorption spectrum relative amplitude (vertical scale) as a function of penetration depth in the block (back-to-front). The absorbed dose at the maximum of the depth-

dose curve was  $2.8 \times 10^4$  Gy.

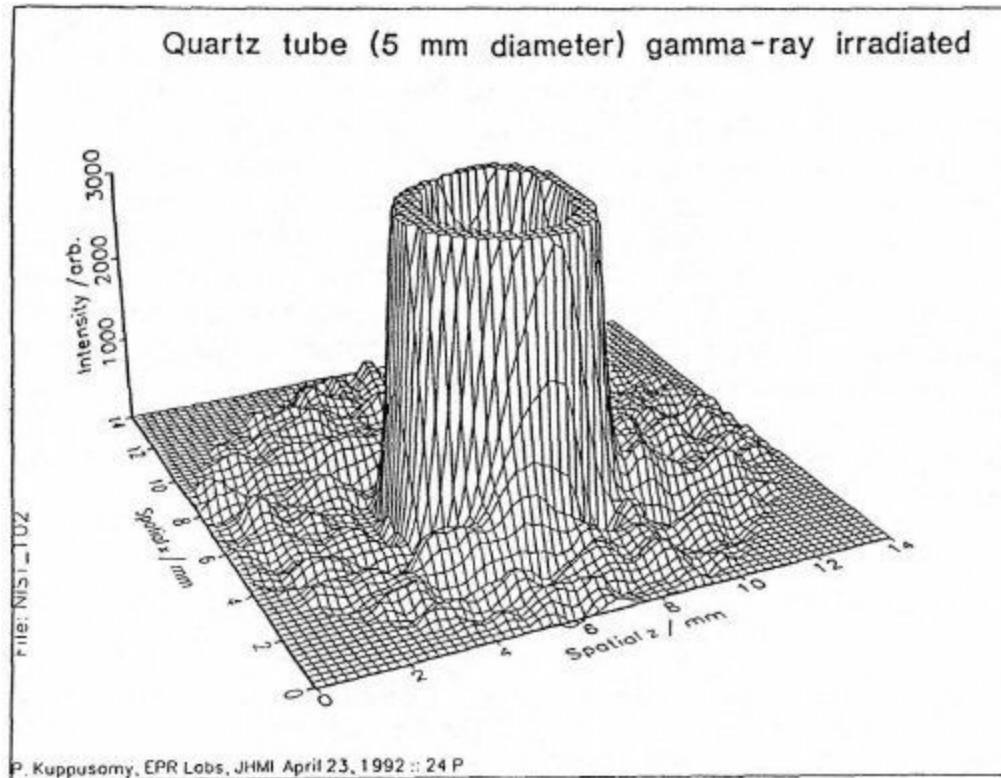

Figure 22. A two-dimensional (2-D; x-z coordinates) image of a quartz tube irradiated uniformly by an annular  $^{60}\text{Co}$  gamma-ray source arrangement around the axis of the tube (73). The vertical scale shows the relatively uniform distribution of the ESR intensity registered with a spatial resolution of 0.222 mm per division.

# Summary

Electron spin resonance (ESR) spectrometry has attracted attention in radiation processing. Not only is ESR analysis of alanine achieving success as a reference dosimetric system, but ESR also provides a means of evaluating short- and long-term effects of radiation on polymers, composites and ceramics, and in the post-irradiation analysis and imaging of absorbed dose in teeth and bone. The broad range of doses ( $10^{-1} - 10^8$  Gy) and dose rates (up to  $10^8$  Gy  $s^{-1}$ ) measurable with relatively high precision and accuracy, and the small size, ruggedness, and the expected inexpensiveness of new sensor materials, such as L- $\alpha$ -alanine pellets and films and other sensor materials (e.g., hydroxyapatite, sugar, quartz, cellulose, etc.), make ESR dosimetry attractive for radiation sterilization dosimetry, radiation treatment planning, nuclear medicine dosimetry, food irradiation, and the study of radiation effects on materials. Within the next few years, there may be a significant impact of this ESR-based analysis on international radiation standards practices and 2-D and 3-D imaging of radiation dose distributions, especially as the trend toward lowering the cost of the analytical equipment and simplifying its operation continues (20). ESR dosimetry may, in fact, be the future method of choice for interlaboratory transfer metrology, process validation, and measurement quality assurance.

Profound improvements in the practice of alanine/ESR dosimetry are currently being made. Mass-produced batches of rugged, low-cost alanine dosimeters are now on the threshold of becoming commercially available. There are also advanced, easy-to-use ESR spectrometers designed especially for dosimetry and requiring no manual instrumental adjustments or tedious dosimeter manipulations. New spectrometer capabilities may be summarized as follows: automated dosimeter transport, positioning, and changing; microprocessor-controlled reproducible instrument settings to minimize instrumental drifts (e.g., RF frequency control, microwave bridge tuning, detector bias current setting); continuous measurement and high sample throughput (as high as 400 dosimeter readings per hour); and automated data logging, evaluation of dosimeter results, and calibration history recall. These developments should result in greater dosimetric precision, ease of use, and cost effectiveness for large-scale dosimetry applied to radiation processing.

# References

1. Aldrich JE, Pass B. Determining radiation exposure from nuclear accidents and atomic tests using dental enamel. *Health Phys* 1988;54:469-471.
2. Alger RS. *Paramagnetic Resonance Techniques and Application*. New York: Interscience; 1968; 13-15.
3. Arnow CL. Benchtop ESR spectrometer 8200 utilizes permanent magnet. Skokie, IL: Micronow Instruments Report; Nov. 1991.
4. Azorin J, Gutiérrez A, Muñoz E, Gleason R. Correlation of ESR with lyoluminescence dosimetry using some sugars. *Appl Radiat Isotopes* 1989;40:871-873.
5. Baccarlo S, Buontempo U, Caccia B, Onori S, Puntaloni M. ESR study of irradiated ethylene-propylene rubber. *Appl Radiat Isotopes* 1993;44:331-335.
6. Bermann F, DeChoudens H, Descours S. Application à la dosimetric de la mesure par resonance paramagnétique électronique des radicaux libre créés dans les acides amines. *Advances in Physical and Biological Radiation Detectors*, STI/PUB/269. Proceedings of Symposium, Vienna 1970, Vienna: IAEA; 1971; 311-325.
7. Bradshaw WW, Cadena CG, Crawford EW, Spetzler HAW. The use of alanine as a solid dosimeter. *Radiat Res* 1962;17:11-21.
8. Bortolin E, Fattibene P, Furetta C, Onori S. ESR of  $Mg_2SiO_4:Tb$  TL phosphor. *Appl Radiat Isotopes* 1993;44:327-330.
9. Box HC, Freund HG. Paramagnetic resonance shows radiation effects. *Nucleonics* 1959;17(1):66-76.
10. Bushfield KW, Garrett RW, Hill DJT, O'Donnell JH, Pommery PJ. Detection of intermediates in irradiated polymers by electron spin resonance spectroscopy. *Polymer Preprints* 1988;29:126-127.
11. Chien JCW, Boss CR. Electron spin resonance spectra of low molecular weight and high molecular weight peroxy radicals. *J Am Chem Soc* 1967;89:571-575.
12. Chien JCW, Boss CR. Polymer reactions. V. Kinetics of auto-oxidation of polypropylene. *J Polymer Sci Past A1* 1967;5:3091-3101.
13. Chong TS, Ohta H, Nakashima Y, Iida T, Ieda K, Saisho H. ESR dating of elephant teeth and radiation dose rate estimation in soil. *Appl Radiat Isotopes* 1989;40:1199-1202.
14. Colacicchi S, Onori S, Petetti E, Sotgiu A. Application of low frequency EPR imaging to alanine dosimetry. *Appl Radiat Isotopes* 1993;44:391-395.
15. Coninckx F, Schönbacher H. Experience with a new polymer-alanine dosimeter in high energy particle accelerator environment. *Appl Radiat Isotopes* 1993;44:67-71.
16. Desrosiers MF. Gamma-irradiated seafoods: Identification and dosimetry by electron paramagnetic resonance spectroscopy. *J Agric Food Chem* 1989;37:96-100.
17. Desrosiers MF. Estimation of the absorbed dose in radiation processed food — 2. Test of the EPR response function by an exponential fitting analysis. *Appl Radiat Isotopes* 1991;42:617-619.
18. Desrosiers MF, McLaughlin WL, Sheahan LA, et al. Co-trial on ESR identification and estimates of  $\gamma$ -ray and electron absorbed dose given to meat and bones. *Int J Food Sci Technol* 1990;25:682-691.



19. Desrosiers MF, Avila MJ, Schauer DA, Coursey BM, Parks NJ. Experimental validation of radiopharmaceutical absorbed dose to mineralized bone tissue. *Appl Radiat Isotopes* 1993;44:459-463.
20. Desrosiers MF, Skinner AF (Eds.) *ESR Dosimetry and Applications*. Proceedings of 3rd International Symposium, Gaithersburg, MD. 1991; *Appl Radiat Isotopes* 1993;44:1-468.
21. Desrosiers MF, Puhl JM, McLaughlin WL. A new EPR dosimeter based on polyvinylalcohol. *Appl Radiat Isotopes* 1993;44:325-326.
22. Eaton GR, Eaton SS, Ohno K (eds.) *EPR Imaging and in vivo EPR*. Boca Raton, FL: CRC Press; 1991.
23. Ettinger KV, Eid AM, Forrester AR. Electron spin resonance readout for LiF doseimeters. *Radiat Prot Dosimetry* 1983;6:166-168.
24. Fattibene P, Desrosiers MF. NIST Gaithersburg 1993; Private communication.
25. Feist H, Regulla D, Wieser A. Is alanine/ESR dosimetry now an alternative to ferrous sulfate dosimetry? *Appl Radiat Isotopes* 1993;44:47-51.
26. Grün R. Present status of ESR dating. *Appl Radiat Isotopes* 1989;40:1045-1055.
27. Grün R, MacDonald PDM. Non-linear fitting of TL/ESR dose-response curves. *Appl Radiat isotopes* 1989;40:1077-1080.
28. Harrah, LA. ESR of radicals produced in Co-60 gamma-irradiated polystyrene. In: Adler G, ed. *Organic Solid State Chemistry*. New York: Gordon and Breach; 1969; 197-210.
29. Hochi A, Furusawa M, Ikeya M. Applications of microwave scanning ESR microscope: Human tooth with metal. *Appl Radiat Isotopes* 1993;44:401-405.
30. Ikeya M. Scanning and computer tomography — ESR microscopy. In: Blümich B, Kuhn W, eds. *Magnetic Resonance Microscopy*. Weinheim: VCH Verlagsgesellschaft; 1992; 133-149.
31. Ikeya M. From earth to space: ESR dosimetry moves toward the 21st century. *Appl Radiat Isotopes* 1993;43:1-5.
32. Ikeya M, Miki T, eds. *ESR Dating and Dosimetry*, Proceedings of 1st International Symposium, Yamaguchi; Tokyo: Ionics; 1985.
33. Ishii H, Ikeya M, Okano M. ESR dosimetry of teeth of residents close to Chernobyl reactor accident. *J Nucl Sci Technol* 1990;27:1153-1155.
34. Janovsk L. Progress in alanine film/ESR dosimetry. *High Dose Dosimetry for Radiation Processing*, STI/PUB/846. Proceedings of Symposium, Vienna 1990. Vienna: IAEA; 1991;173-187.
35. Judeikis HS, Hedgpeth H, Siegal S. Free radical yields in polytetrafluoroethylene as the basis for a radiation dosimeter. *Radiat Res* 1968;35:247-260.
36. Kojima T, Tanaka R. Polymer-alanine dosimeter and compact reader. *Appl Radiat Isotopes* 1989;40:851-857.
37. Kojima T, Haruyama Y, Tachibana H, et al. Development of portable ESR spectrometer as a reader for alanine dosimeters. *Appl Radiat Isotopes* 1993;44:361-365.
38. Kuppusamy P, Chzhan M, Vij K, et al. 3-D spectral-spatial EPR imaging of free radicals in the heart: A technique for *in vivo* imaging of tissue metabolism and oxygenation. Proceedings of National Academy of Sciences. Washington: NAS; 1993;90-111.
39. Kuroda S, Miyagawa I. ENDOR study of an irradiated crystal of L-alanine: Environment of the stable  $\text{CH}_3\text{CHCO}_2$  radical. *J Chem Phys* 1982;76:3933-3944.

40. Maier D, Schmalbein D. A dedicated EPR analyzer for dosimetry. *Appl Radiat Isotopes* 1993;44:345-355.
41. McLaughlin WL. ESR dosimetry. *Radiat Prot Dosimetry* 1993; 46 (in press).
42. McLaughlin WL, Boyd AW, Chadwick KH, McDonald JC, Miller A. *Dosimetry for Radiation Processing*. London: Taylor and Francis; 1989; 173-176, 190, 200.
43. Morehouse K, Desrosiers MF. Electron spin resonance investigations of gamma-irradiated shrimp shell. *Appl Radiat Isotopes* 1993;44:429-437.
44. Morita Y, Ohno K, Ohashi K, Sohma J. ESR imaging investigation on depth profiles of radicals in organic solid dosimetry. *Appl Radiat Isotopes* 1989;40:1237-1232.
45. Morton JR, Schneider CCJ. ESR dosimetry with magnesium sulfate. *Radiat Prot Dosimetry* 1993; 46 (in press).
46. Nakajima T. Sugar as an emergency populace dosimeter for radiation accidents. *Health Phys* 1988;55:951-955.
47. Nakajima T. Estimation of absorbed dose to evacuees at Pripyat-City using ESR measurements of sugar and exposure rate calculations. *Appl Radiat Isotopes* 1993;44 (in press).
48. Nam JW, Regulla DF. The significance of the International Dose Assurance Service for radiation processing. *Appl Radiat Isotopes* 1989;40:953-955.
49. Nette HP, Onori S, Fattibene P, Regulla DF, Wieser A. Coordinated research efforts for establishing an International Radiotherapy Dose Intercomparison Service based on the alanine/ESR system. *Appl Radiat Isotopes* 1993;44:7-11.
50. Nishimoto S-I, Mu Ye, Yiqun Lu, Kawamura T, Kagiya T. ESR spectroscopic characterization of the methyl viologen dosimeter in poly (vinyl alcohol) film. *Radiat Phys Chem* 1988;322:727-730.
51. O'Donnell JH, Pommery PJ. ESR studies of degradation in polymers. I.  $\gamma$ -irradiation of poly (styrene-co-methyl methacrylate) at 77° K. *J Polym Sci, Symposium No. 55* 1976:269-278.
52. Olsen KJ, Hansen JW, Waligorski MPR. ESR dosimetry in calibration intercomparisons with high energy photons and electrons. *Appl Radiat Isotopes* 1989;40:985-988.
53. Oommen IK, Nambl KSV, Sengupta S, Gundu Rao TK, Ravikumar M. Lactose and "Tris" lyoluminescence dosimetry systems and ESR correlation studies. *Appl Radiat Isotopes* 1989;40:879-883.
54. Pass B, Aldrich JE. Dental enamel as an *in vivo* radiation dosimeter. *Med Phys* 1985;12:305-307.
55. Raffi J, Evans JC, Agnel J-OL, Rowlands CC, Lesgards G. ESR analysis of irradiated frogs legs and fishes. *Appl Radiat Isotopes* 1989;40:1215-1218.
56. Regulla DF, Deffner U. Dosimetry by ESR spectroscopy of alanine. In: McLaughlin WL, ed. *Trends in Radiation Dosimetry*. Oxford: Pergamon Press; *Int J Appl Radiat Isotopes* 1982;33:1101-1114.
57. Regulla DF, Deffner U. A system of transfer dosimetry in radiation processing. *Radiat Phys Chem* 1983;22:305-309.
58. Regulla DF, Scharmann A, McLaughlin WL, eds. *ESR Dosimetry and Applications, Proceedings of 2nd International Symposium, Munich, 1988*; *Appl Radiat Isotopes* 1989;40:829-1246.

59. Regulla D, Bartalotta A, Deffner U, Onori S, Pantaloni M, Wieser A. Calibration network based on alanine/ESR dosimetry. *Appl Radiat Isotopes* 1993;44:23-31.
60. Rotblat J, Simmons JA. Dose-response relationship in the yield of radiation-induced free radicals in amino acids. *Phys Med Biol* 1963;7:489-497.
61. Sharpe PHG, Arber JM. Fading characteristics of irradiated alanine pellets: The importance of pre-irradiation conditioning. *Appl Radiat Isotopes* 1993;44:19-22.
62. Sollier TJL, Mosse DC, Chartier MMT, Joli JE. The LMRI ESR/alanine dosimetry system: description and performance. *Appl Radiat Isotopes* 1989;40:961-965.
63. Stachowicz W, Burlińska G, Michalik J, Dziedzic-Gocławska A, Ostrowski K. Applications of the EPR spectroscopy to radiation-treated materials in medicine, dosimetry, and agriculture. *Appl Radiat Isotopes* 1993;44:423-427.
64. Stewart EM, Stevenson NH, Gray R. Detection of irradiation in scampi tails — Effects of sample preparation, irradiation dose and storage on ESR response of the cuticle. *Int J Food Sci Technol* 1992;27:125-132.
65. Sueki M, Eaton SS, Eaton GR. Spectral-spatial EPR imaging of irradiated silicon dioxide. *Appl Radiat Isotopes* 1993;44:377-380.
66. Tchien A, Greenstock CL, Trivedi A. The use of sugar pellets in ESR dosimetry. *Radiat Prot Dosimetry* 1993;46:191-201.
67. Trivedi A, Greenstock CL. Use of sugars and hair for ESR emergency dosimetry. *Appl Radiat Isotopes* 1993;44:85-90.
68. Uribe RM, McLaughlin WL, Miller A, Dunn TS, Williams EE. Possible use of electron spin resonance of polymer films containing leucodyes for dosimetry. *Radiat Phys Chem* 1981;18:1011-1016.
69. Wieser A, Regulla, DF. ESR Dosimetry in the “gigarad” range. *Appl Radiat Isotopes* 1989;40:911-913.
70. Wieser A, Regulla, DF. Cellulose for high-level dosimetry. *High-Dose Dosimetry for Radiation Processing*, STI/PUB/846. Proceedings of International Symposium, Vienna 1990. Vienna: IAEA; 1991; 203-212.
71. Wieser A, Lettan C, Fill U, Regulla DF. The influence of non-radiation induced ESR background signal from paraffin-alanine probes for dosimetry in the radiotherapy range. *Appl Radiat Isotopes* 1993;44:59-65.
72. Williams JL, Dunn TS, Sugg H, Stannett V. Radiation stability of polypropylene. *Radiat Phys Chem* 1977;9:445-554.
73. Figure courtesy of Zweier JL, Kuppusamy P, Schauer DA. EPR Laboratories and Department of Medicine. The Johns Hopkins University School of Medicine, Francis Scott Key Medical Center, Baltimore, Maryland.

---

<sup>1</sup> In many texts referred to as electron paramagnetic response (EPR).

<sup>2</sup> The unit of quantity *absorbed dose* is the named unit, *gray* (Gy), defined as  $1 \text{ Gy} = 1 \text{ Jk}^{-1}$ . This unit is related to the older unit, rad, as  $1 \text{ Gy} = 1 \text{ rad}$ , or  $1 \text{ kGy} = 100 \text{ krad} = 0.1 \text{ Mrad}$ .

<sup>3</sup> Paramagnetic centers may also exist as free radicals trapped by transition metals, rare earth ions, or organic chelates or clathrates.

<sup>4</sup> The unit of the quantity, *magnetic field strength*, is the named unit, tesla (T), where tesla is related to the order unit, gauss (G),

as  $1 \text{ T} = 10^4 \text{ G}$ .



# Radiation Process Data Collection, Analysis, and Interpretation

Michael C. Saylor<sup>\*</sup>, Steven W. Baryschpolec<sup>\*\*</sup>, Lisa M. Hurwitz<sup>\*\*</sup>, and  
William L. McLaughlin<sup>\*\*\*</sup>

*\*Dunn Loring, Virginia, U.S.A.*

*\*\*Johnson & Johnson, U.S.A.*

*\*\*\*National Institute of Standards and Technology, U.S.A.*

# Introduction

For the past two decades, Johnson & Johnson has sponsored conferences that have been used as a vehicle for the dissemination of information, the promotion of concept, and the review of developments embedded in the history of radiation sterilization science and technology. The 1993 Kilmer Conference is yet another example of this progression.

A review of the published proceedings of conferences held in the 1970s and early 1980s reveals, for example, the detailing of analytical expressions governing the design and operation of gamma-based irradiation mechanisms (5), and the conceptualization of elementary aspects of process control algorithms in gamma (16) and electron accelerator-based radiation sterilization facilities (22). Hindsight allows us the opportunity to review one of the many reasons that some of these concepts have met with limited application and/or acceptance.

Prior to 1984, the capital expense limited radiation-based sterilization technology's access to affordable, state-of-the-art digital technology in the form of programmable logic controllers (PLCs), computers, and manufacturing-oriented programming languages. These components were utilized, however, in selected device manufacturing and pharmaceutical sectors. All of this changed as affordable digital data processing equipment became "cost-feasible" and desirable as an integral part of process quality control programs.

Technological advances in dosimetry, process equipment, computerization, and communications, while beneficial, continue to generate massive quantities of information whose value in sterilization and quality assurance program development can easily be diminished by improper planning, analysis, and presentation. This paper reviews key aspects of the role of radiation process data collection, analysis, and interpretation at present and in the near future as radiation sterilization technologies continue to evolve.

# Radiation Sterilization – Current Parameters

Much has been written regarding the technologies and techniques involved in radiation sterilization of medical products (8,12). In all cases, it is found that Good Manufacturing Practice (GMP) and/or Good Laboratory Practice (GLP) philosophies go hand-in-hand with the implementation of these technologies. Processes conducted in radiation sterilization require comprehensive documentation packages that allow compliance auditors to review records now and in the future. Comprehensive record keeping allows one to determine why, how, and by whom the work was done, who was in control, what processing parameters were controlled, what equipment was used, what results were obtained, what, if any, problems were encountered, and how these problems were overcome.

In all cases, validation of the process is a fundamental requirement (Figure 1). Collecting documented evidence helps provide assurance that a process will consistently produce a product meeting its pre-determined specifications (11) and is thus an active ingredient in manufacturing support programs.

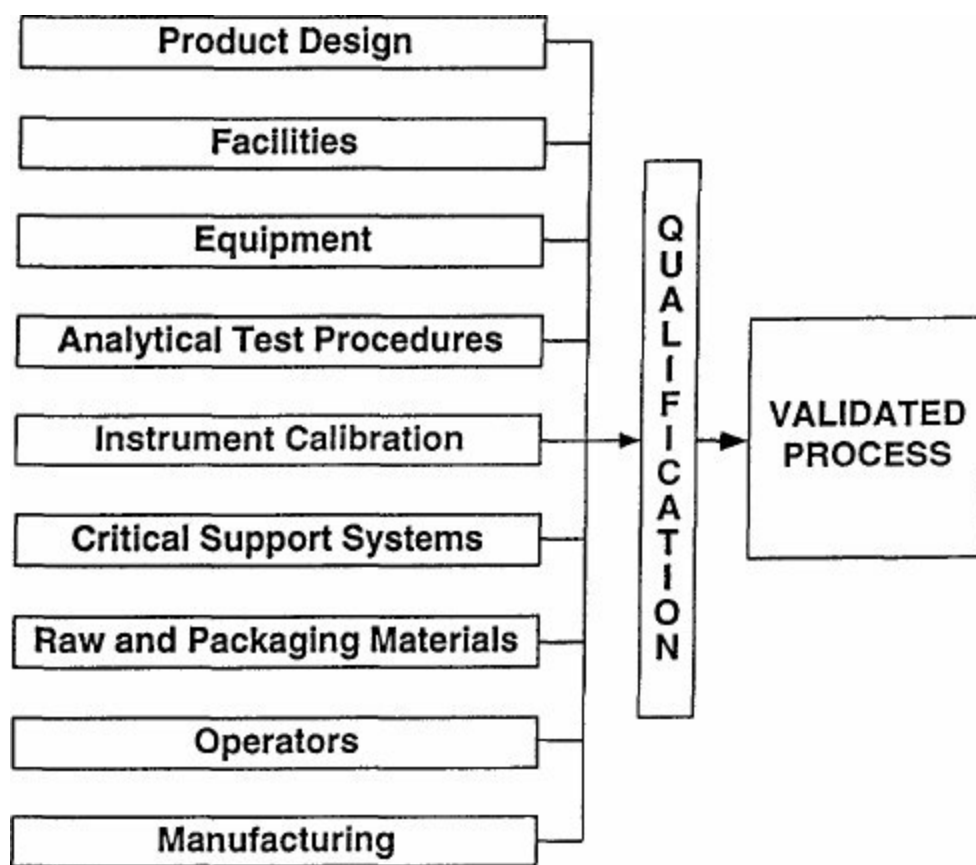

Figure 1. Simplified Block Diagram of the Main Features of a Sterilization Process Validation Program

For the purposes of this paper, we will focus our attention on aspects associated with the measurement of the direct absorption and scattering events associated with high energy electrons. These are introduced into the product either directly (electron accelerators) or indirectly through photon interaction at an atomic level (gamma and X-ray irradiators).

Energy deposition in a “load” of product is typically defined by the results of comprehensive dose mapping exercises involving individual dose points as distinct entities. Two approaches



can be taken in developing dose mapping strategies for radiation process qualification:

1. The “oracle” or “black box” approach, whereby one asks questions of the sterilization process system without being able to look “inside”; or
2. The “completeness” or “worst case” approach, whereby a challenge is made to the sterilization processing system that is deemed to be as demanding as any other product composition/geometry in a given class of process events.

Results of this and related qualification exercises (minimum dose selection via dose setting methodology, maximum dose selection via material compatibility testing results) define the upper and lower dose limits. These limits are established for a specific radiation sterilization process under the fixed conditions of composition, geometry, and density associated with the product load.

Dosimetry is thus employed as an indirect measurement of routine process efficacy and material degradation. It can be assumed to be reliable through the use of well-defined dosimetry systems (17,19, 21) and established system operating procedures (4).

“Dosimetric” release of irradiated products has helped the industrial irradiation business grow at a rapid pace over the past 15 years. However, it is important to realize that our primary release mechanism remains somewhat one-dimensional (1-D). Product release is usually based on two reported measurements of one operating parameter, namely measured absorbed dose limits.

# Role of Standards in Statistical Analysis

As previously mentioned, the principle release criteria in radiation processing is measured process minimum and maximum absorbed dose. It is not surprising that the bulk of industry and standards organization effort has been placed on addressing the measurement uncertainty associated with a given 1-D dosimetric technique.

Some current sources of information regarding statistical analysis of measurements come from ISO/IEC/OIML/BIPM (International Organization for Standardization, International Electrotechnical Commission, International Organization of Legal Metrology, and International Bureau of Weights and Measures, respectively) (15), the National Institute of Standards and Technology (NIST) (32), and the American Society for Testing and Materials (ASTM) (4). A brief opinion regarding these standards, documents and drafts is warranted at this time.

The ISO document (15) attempts to supply the end-user with statistical principles that cover a broad range of measurement applications including: production quality assurance/quality control (QA/QC), basic and applied research and calibration standards (both national and international), as well as regulatory compliance. As one might expect, a document covering such diverse topics for virtually all forms of measurement systems can pose a challenge to the end-user in terms of interpretation and translation into the realm of dosimetry system measurement uncertainties.

NIST has created a document that end-users can use to interpret U.S. national standard lab measurements, including those associated with radiation dosimetry results (32). ASTM Subcommittee E10.01 has formally addressed incorporation of relevant elements and terminology of the ISO document in its standard guide for estimating uncertainties in radiation process dosimetry data. The ASTM effort is currently in the final draft stage of development.

It should be noted that none of these technical notes and standards directly address the use and construction of process control charts as they apply to radiation sterilization operating parameters. This continues to be an area where our industry needs to invest in developing the appropriate interfaces with standards organizations.

# Developments in Dosimetric Technique

General dosimetry techniques are supported in the open literature, textbooks (19), and in standard practices and methods (4). There are three significant points to note in the development of dosimetry systems over the past 10 years:

1. Commercial emphasis has moved away from producing many different types of dosimetry systems to developing specific systems with significant levels of measurement “precision” ( $< \pm 1.5\%$ ). Alanine/ESR, dichromate, and GafChromic™ (28) radiochromic film are examples of such systems.
2. Development of dosimetry films capable of supporting 2-D dose mapping bears significance in our search for greater comprehension of the energy deposition process associated with radiation processing. GafChromic™, for example, has had increasing application in the area of multi-dimensional dose distribution determination (18,29,30,39).
3. The quest for dosimetry systems with expanded dynamic dose ranges has created interest in sectors beyond medical device sterilization (radiology, radiotherapy, industrial radiography, etc.).

# Multi-Dimensional Absorbed Dose Analysis

In reality, dose mapping represents 2-D and 3-D evaluation of the energy deposition profile associated with a given irradiation process (Figure 2). The principle reasons that dose map results have been viewed as 1-D entities in the past is due to the lack of affordable graphics display programs/equipment, the lack of regulatory requirements geared towards the use of process control charts (12,31), and end-user training. Yet one now finds small groups in our industry pursuing this avenue of data analysis with vigor (24).

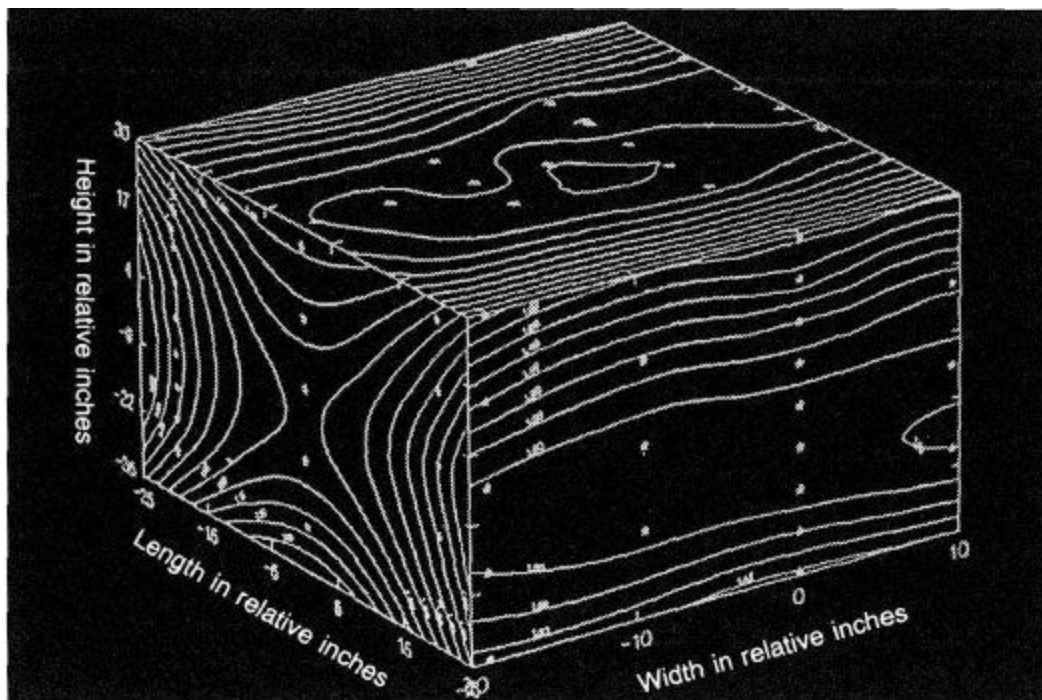

Figure 2. 3-D Representation of Dose Distribution Observed in a Cs-137 Gamma Irradiation Facility. (Courtesy of Titan Scan Systems, Ref. 24).

Industry's attitude towards high data-density dose mapping began to change during the late 1980s due in part to the appearance of high quality commercial radiochromic film media and the proliferation of high performance desktop microcomputers. The availability of fully-defined concepts and mathematics associated with the visualization of information and quantitative image analysis (35,36,38, 39), coupled with the demands made for visualization and image analysis software by other generalized large data set sectors such as physics, chemistry, meteorology, and economics (6,23,25,27) has led to inexpensive analysis techniques applicable to the radiation processing industry.

The utility of this approach to dose distribution determination is depicted in Figures 3, 4, and 5. Examples of large data set interpretation for gamma, x-ray, and electron beam applications exist in the literature (18,29), and the number of research and QA groups performing 2-D and 3-D analysis continues to grow.



Figure 3. Two-Dimensional (2-D) Radiochromic Film and Plate Scanning Dosimetry System  
Exposed radiochromic film can be seen in the lower left-hand corner of this photograph. (Courtesy of AECL Research, Ref. 30).

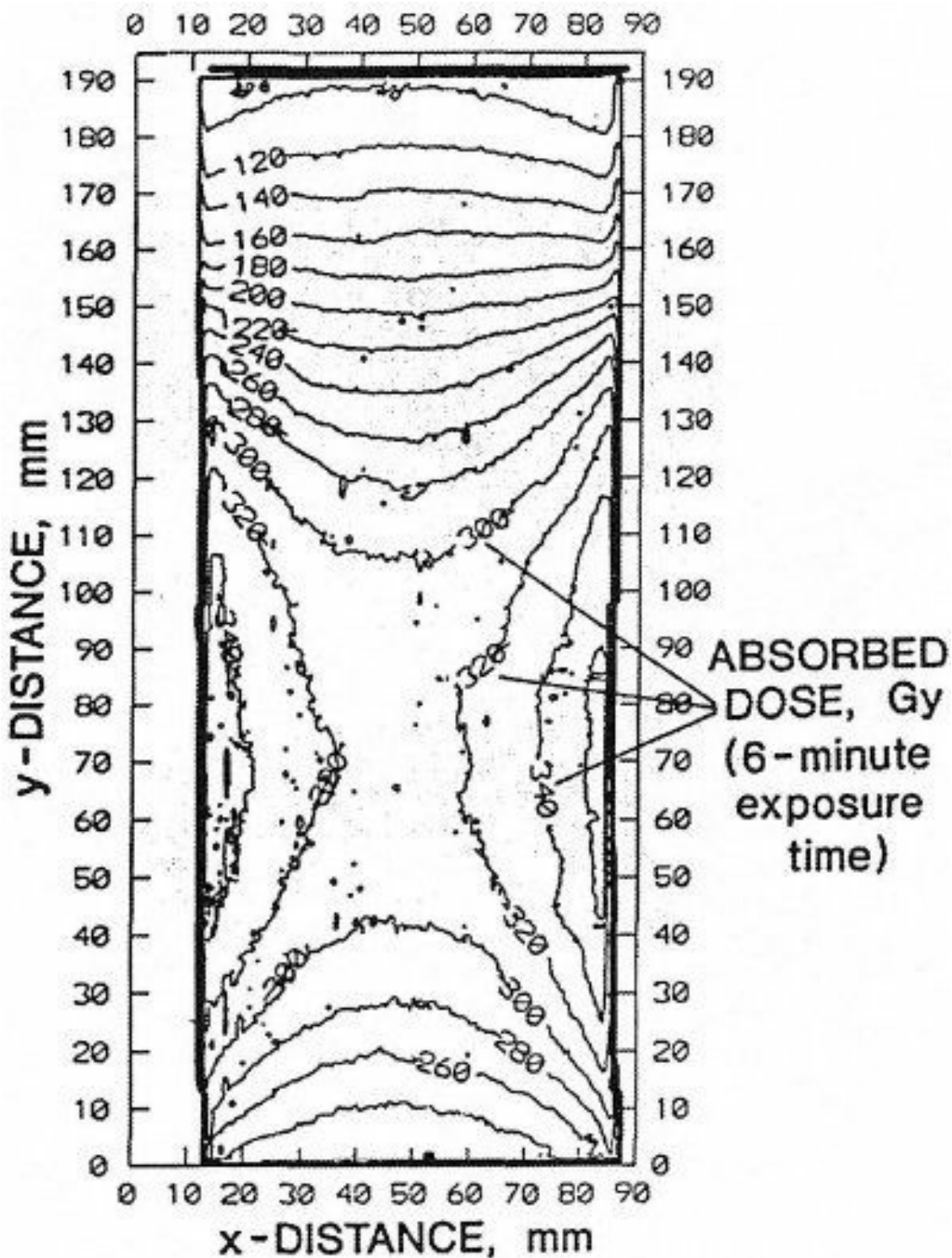

Figure 4. Two-Dimensional (2-D) Scanned Film Results Demonstrating the Absorbed Dose Gradients Along Two Central Axes of a Gamma-Based Calibration Source GafChromic™ radiochromic dosimetry media and NIST's HeNe laser-based scanning densitometer were used in this experiment (39).

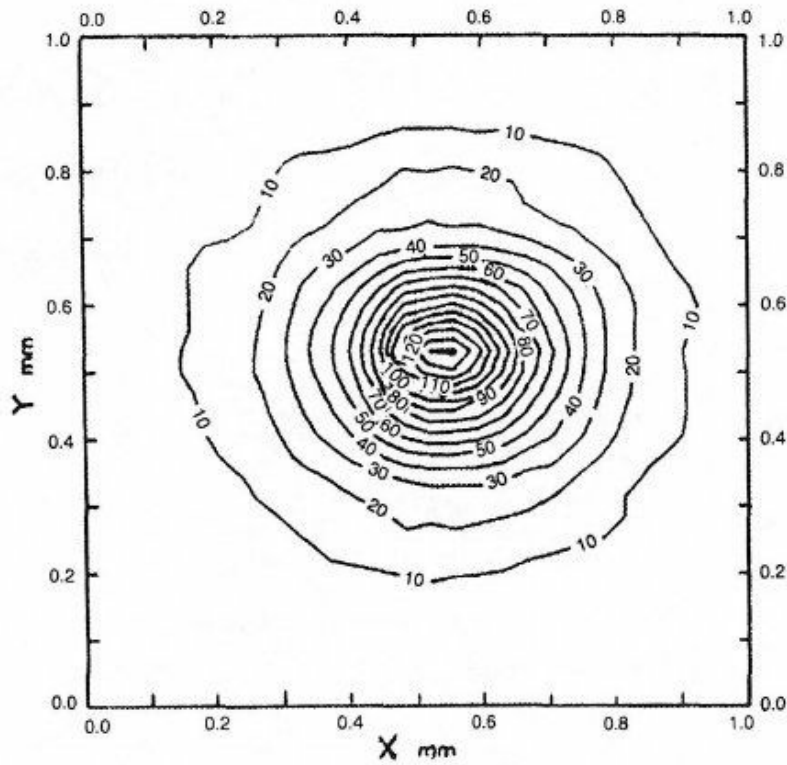
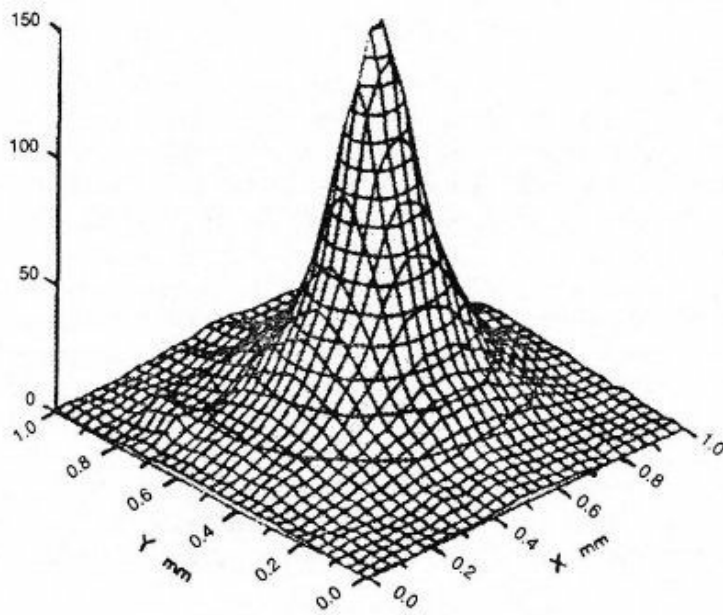

Figure 5. 2-D and 3-D Scanned Film Results Demonstrating the Absorbed Dose Gradients Associated with a Quasi-Point Radiation Source

# SSG's Model Dosimetry Data System

Johnson & Johnson's Sterilization Sciences Group (SSG) launched a comprehensive radiation support services program several years ago, providing assistance to operating facilities within the Johnson & Johnson Family of Companies. Services include: radiation dosimetry system calibration, assistance with dose map design, dosimetry system development and system evaluation, training, and on-site support.

Early on it was realized that the volume of radiation sterilization-related data generated throughout the Johnson & Johnson network would be massive. Without a comprehensive computer-based data collection and analysis program, much of the knowledge that could be gained by integrating data and results could be lost. Furthermore, the number and types of individual dosimetry systems that SSG would need to support (Figure 6) required flexibility in terms of dosimetry device and data system integration capabilities. It became obvious that a "Model System", if properly designed, could be of use to Johnson & Johnson affiliates involved in radiation research, processing, and on-site dosimetry system intercomparison exercises (Figure 7).

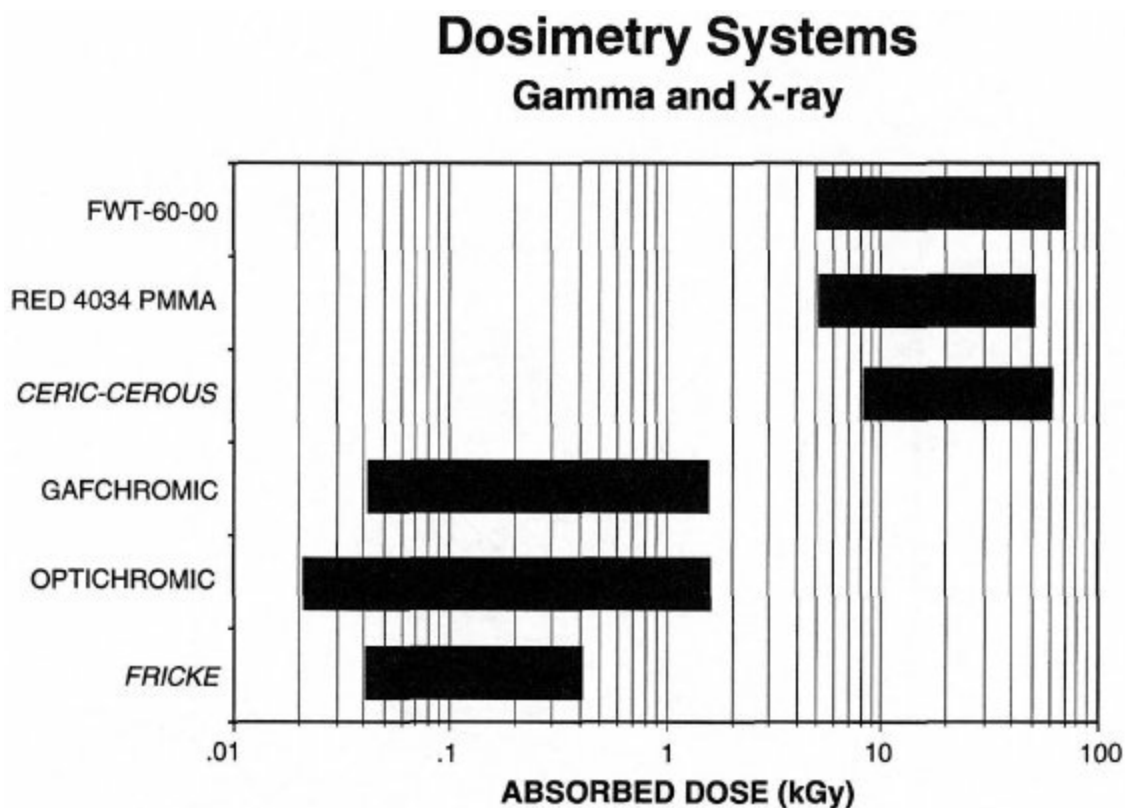

Figure 6. Functional Absorbed Dose Ranges for the Various Dosimeter Types Supported by the SSG Model System



## Calibration of Routine Dosimetry Systems

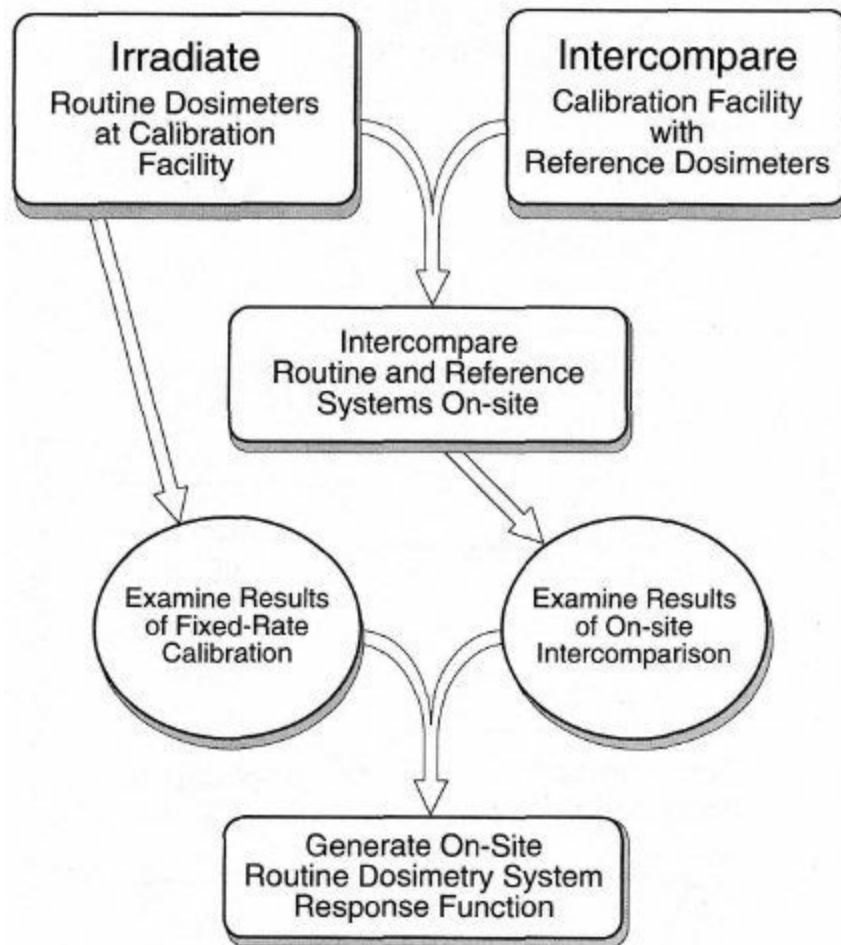

Figure 7. Flow Chart Corresponding to a Generalized Plan for On-Site Verification of Dosimetry System Response Function (Calibration Curve)

SSG began the process of automating in-house dosimetry data generation and collection by producing a statement of functional requirements and goals for a “Model System” (Figure 8). Details associated with this process are listed in Table I. Dosimetry systems and related instrumentation supported by the Model System are described in Table II.

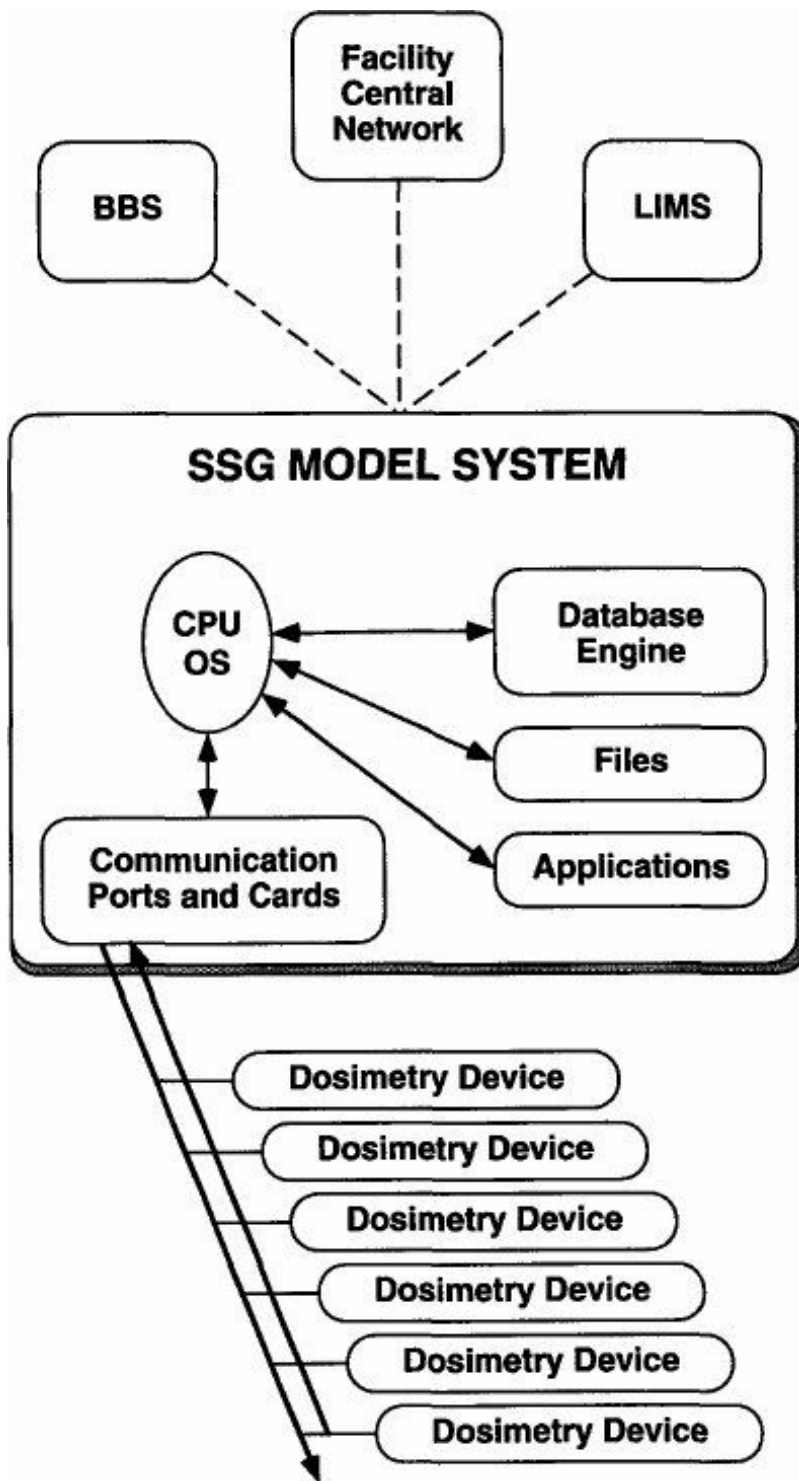

Figure 8. Block Diagram of the Main Features of Johnson & Johnson Sterilization Sciences Group (SSG) Model Dosimetry Data Collection System

Table I. Functional Requirements and Goals of the SSG Model System

- Enhance laboratory productivity
- Reduce or eliminate repetitive data transcription tasks
- Reduce technician-related errors
- Utilize event-driven man-machine interfaces
- Provide a user-friendly interface
- Allow for a network of instruments to access the data system

- Allow for real-time data acquisition on multiple dosimetry systems
  - Evaluate and purchase quality hardware and software whenever possible
  - Minimize the need for generation of customized programming code
  - Allow for expansion and modification as the commercial hardware and software sectors evolve
  - Provide for security and back-up mechanisms
  - Data collected must be transferable to commercial applications such as spreadsheets, database packages, word processors, graphics packages, etc.
  - Technology should be transferable to all other gamma irradiation facilities
  - Provide adequate user documentation and change control documentation
- 

**Table II. Analytical Devices Supported on the Network of Instruments**

---

- UV-Vis scanning spectrophotometer
  - Photometer (radiochromic films)
  - Photometer (radiochromic optical waveguides)
  - Digital thickness gage
  - Digital thermometer
  - Electrochemical cell
- 

The principle concepts behind automation of the SSG radiation dosimetry lab were that dosimetry devices should be connected to a single computer whose function was determined to be collection and storage of data (Figure 9), and that a database format of data storage and retrieval would be beneficial (20). Manufacturers of radiation process monitoring equipment and related systems are aware of the interface requirements for their process data collection systems and dosimetry data collection systems, and have designed their products with said interface in mind (9,24).

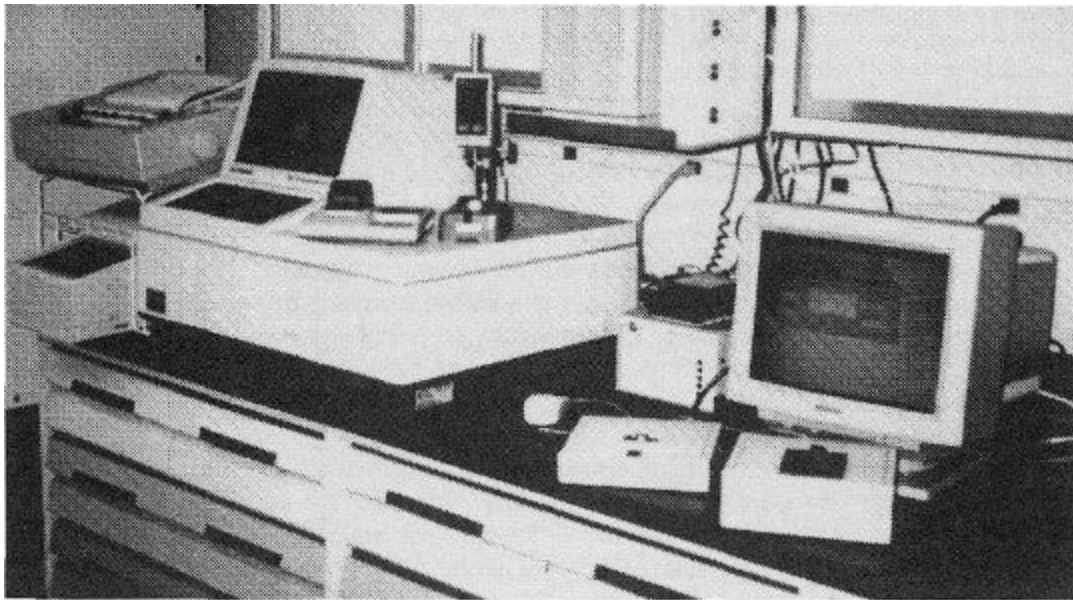

Figure 9. Dosimetry Data Collection Instruments Connected to the SSG Model System Prototype Data System

Software purchased and/or created by SSG allows for the production of appropriate reports. The data system is able to use more than one data collection device at a time. Further, the status of each piece of analytical instrumentation can be seen in a “windowed” format, allowing for event-driven interaction (Figure 10) and efficient end-user interface.

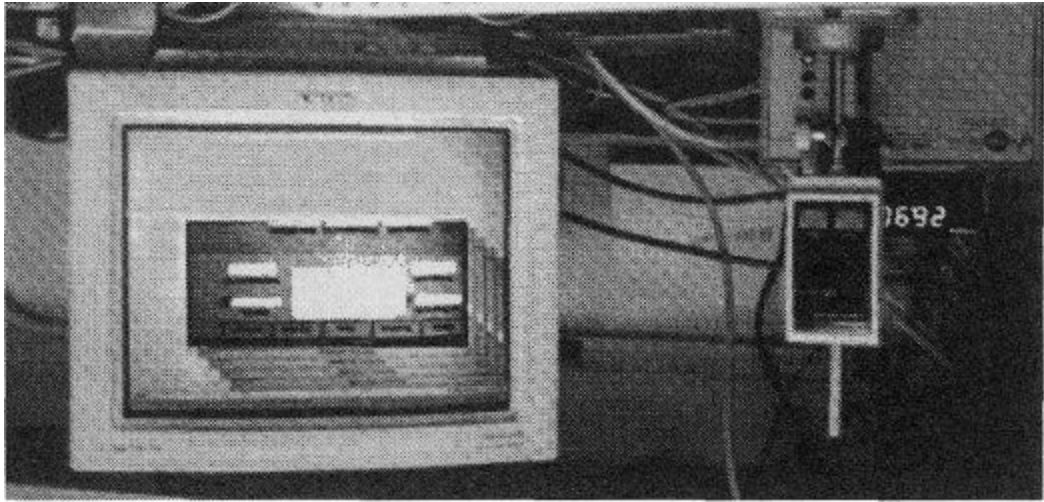

Figure 10. View of the SSG Model System’s Stacked Data Windows, Thickness Gage, and Temperature Monitor

To date, a prototype Model System has been assembled and is currently going through preliminary installation and operational qualification exercises (IQ, OQ). An example of the utility of this data system is discussed in the next section.

# SSG's Remote Bulletin Board System

The general acceptance of electronic message and data transfer systems encapsulated in stand-alone and networked computer systems can be seen in the following estimates (10):

- 40,000 public Bulletin Board Systems (BBS)
- 120,000 private (limited access) BBS's
- Over 1.3 million users on the Internet

Indeed, a "... culture has grown in the physics community ..." where "... electronic preprint archive and distribution systems ..." are replacing the informal nature of traditional message boards (33).

A remote BBS was established by SSG in order to facilitate data transfer from the prototype SSG Model System to researchers and QA groups throughout the Johnson & Johnson Family of Companies. Figure 11 illustrates an end result of a remote request to the technician operating the prototype Model System and SSG's Gammacell 220 irradiator.

The purpose of the experiment depicted in Figure 11 is to irradiate samples of a commercial manufacturer's experimental radiochromic dye film and produce data sets that could be used to determine the value of this type of dosimeter to radiation-related QA/QC functions. The remote query requests that unirradiated and irradiated films be evaluated in the visible range using SSG's scanning spectrophotometer and that all data corresponding to the scans and associated irradiation events be placed on the BBS in the form of a pre-defined worksheet template. The downloaded data file is then reviewed at the remote site using a variety of mathematical and graphical techniques, and a preprint graphic synopsis is forwarded to SSG for use in an executive project summary and for the group's company newsletter.

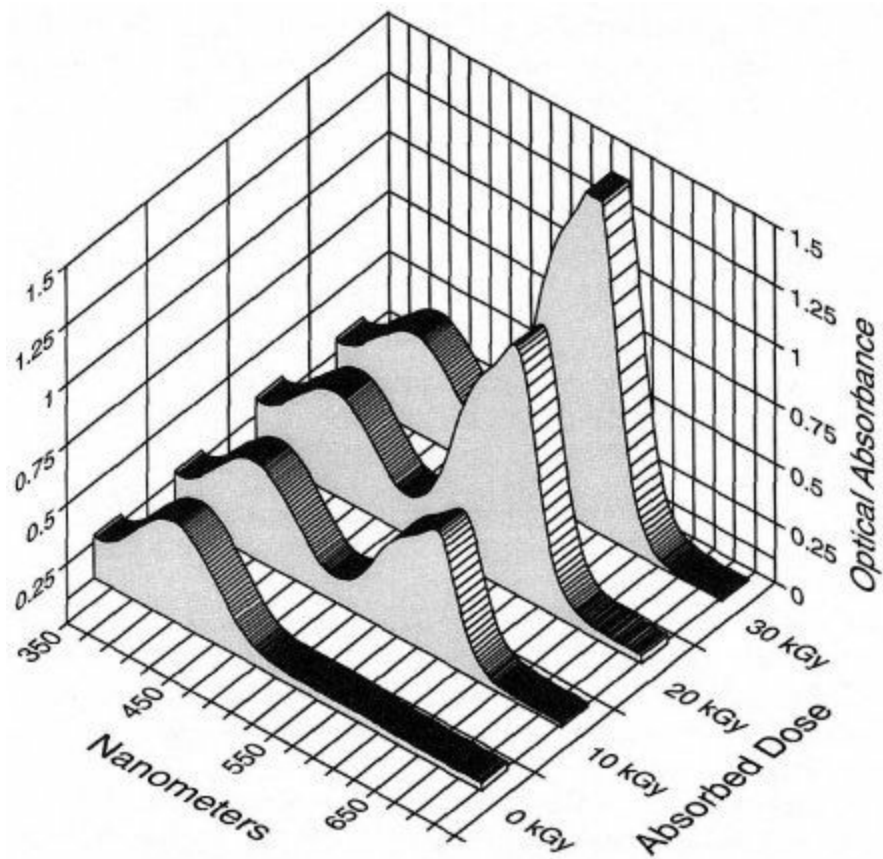

Figure 11. 3-D Representation of the Radiochromic Response of an Experimental Radiochromic Dye-Based Film

# Data System Development and Validation

## *Introduction*

One would be remiss if the necessity and value of data system validation were not studied in detail. Much of what was learned in developing SSG's prototype Model System was derived from developing an approach to data system validation for the final system configuration. Some of the significant details of this process are described in the next sections.

## *General Philosophy*

The objective in computer-based system validation, like any other validation effort, is to provide documentation that the system is doing, and will continue to do reliably and repeatedly, what it is intended to do. This ensures that both the hardware and software functions are properly designed, the process is monitored/controlled, and the resultant data are manipulated as intended.

The user of the system has the final responsibility for the validation of the system. The user may request assistance of other qualified personnel in the execution of the validation. This assistance may be from within the company or from outside qualified personnel.

## *Benefits of Automation*

Table III describes some of the perceived benefits derived from validating the automated data collection and analysis processes.

**Table III. Benefits Derived from Validation**

---

- Documentation objectives are identified
  - Company requirements are established up front
  - Regulatory considerations are addressed
  - Quality is built into the system
  - System maintenance efforts are minimized
  - Process quality and reliability are improved
  - Understanding of the process improves
- 

## *Barriers to Successful Automation*

Table IV describes some of the perceived hurdles that needed to be overcome in order to proceed with successful system development. Specifications, management commitment, and guidelines were felt to play significant roles in system development.

Validation of a computerized system demands resources in the form of time and personnel. If specifications for the system are not current or complete, the end user will not have his/her needs met. This could result in a longer validation period due to numerous programming changes followed by numerous revalidation exercises.

**Table IV. Barriers to Successful Process Data Automation**

---

- Inadequate specifications
  - Lack of management commitment
  - Lack of detailed formal guidelines
  - Lack of expertise on the part of end-users
  - Lack of functional intra-group interfaces
- 

Lack of detailed formal guidelines was also viewed as potentially problematic. The FDA “Blue Book” or “Guide to Inspection of Computerized Systems in Drug Processing” (37) provided some guidance. Unfortunately, this document does not adequately recognize the existence of a category of software that falls between operating systems and application software, namely, configuration software. Software that is modular and configurable to meet the requirements of the process is essential in process control and associated dosimetry applications.

The Pharmaceutical Manufacturers Association (PMA) Computer Software Validation Committee (CSVC), which was formed a few years after the FDA guideline was released, has published articles that highlight specific areas of the software development life cycle (7,26,34). These articles maintain consistency with statements in the FDA guideline and serve as a tool for the end-user in pursuing system validation.

Additional guidance is found in ANSI (2), ASTM (3), IEEE (13), and ISO documents (14).

### *System Validation*

Table V lists specific items related to process data system validation. One major task in this process is the generation of a validation protocol. This protocol must define the scope of the task, the activities to be performed, important milestones, reports required, and the responsible parties. Investigating existing technology (hardware and software) is also found to be an integral part of this process.

**Table V. Major Steps in Process Data System Validation**

---

- Formulation of a validation plan
  - Definition of functional requirements
  - Selection and qualification of vendors
  - Definition of the automated system specification
  - Development and testing of hardware
  - Development and testing of software
  - Performance testing of equipment installation
  - Performance testing of equipment operation
  - Integration of data system with related equipment
  - Definition of on-going monitoring policy
  - Definition of criteria associated with change control programs
-



The validation program for a computer system can be separated into four phases. Note that these phases reflect the life-cycle approach that has become widely accepted for software validation. These phases include:

1. Prequalification (design and specification);
2. Qualification (IQ, OQ);
3. Validation (testing); and
4. On-going Evaluation

System specification represents one of the most important documents in the validation program. This specification defines in detail what the system is designed to do and how it will accomplish its tasks.

Precise review must be performed in the development of this specification to ensure an accurate and complete description of requirements of the system. This time and effort are well spent during the early stages of the project. The tendency to underestimate the importance of the system specification and begin programming and purchasing equipment can generate costs that grow exponentially when correcting or adding features during system maintenance cycles.

*Change Control*

To preserve the validated status of the system, review mechanisms must be in place that enable recognition of significant system changes. Review of change and its effect on validation status are performed by representatives from appropriate areas (QA, QC, operations, etc.). If the change does affect the validation, then requalification must be performed and documented. Changes to software must be performed by trained and experienced personnel using industry-developed standards.

*Common Problems and Regulatory Concerns*

In addition to studying the validation process in-depth, SSG performed a review of audit results of computerized systems employed in the pharmaceutical industry. The results of this survey are displayed in Table VI and have been found to be informative in terms of developing the validation exercise and related protocols.

**Table VI. Survey of Common Violations Cited for Data and Process Control Systems**

- o Organizational responsibility not clearly defined
- o SOPs are absent, outdated or written but not approved
- o No formal method of system development life cycle
- o Lack of formal testing programs
- o Insufficient and inadequately documented preliminary testing
- o Insufficient and inadequately documented final testing
- o Inadequate change control
- o Insufficient audit trails and related mechanisms
- o Inadequate and/or undocumented training of end-users

- o Lack of a formal disaster recovery plan
  - o Lack of adherence to documented security policies
  - o Lack of incident reporting
  - o Lack of user documentation
-

# The Future

Regardless of the technical and political hurdles present in the development of high performance desktop computing and high speed communications (1), the future of radiation process control and related analysis lies in the areas of simulation (Monte Carlo and point-kernel analysis) and multi-dimensional dosimetric image analysis (29).

Approaches to parametric release of irradiated products will develop (12) in conjunction with the evolution of secondary standards practices in the measurement of absorbed dose and dose distribution. Parametric release algorithms will, however, be required to address the nuances associated with the phasing of distinct product lots into fixed photon or electron fields. As can be seen from the dosimetry results portrayed in Figure 12, such algorithms will indeed need to be robust!

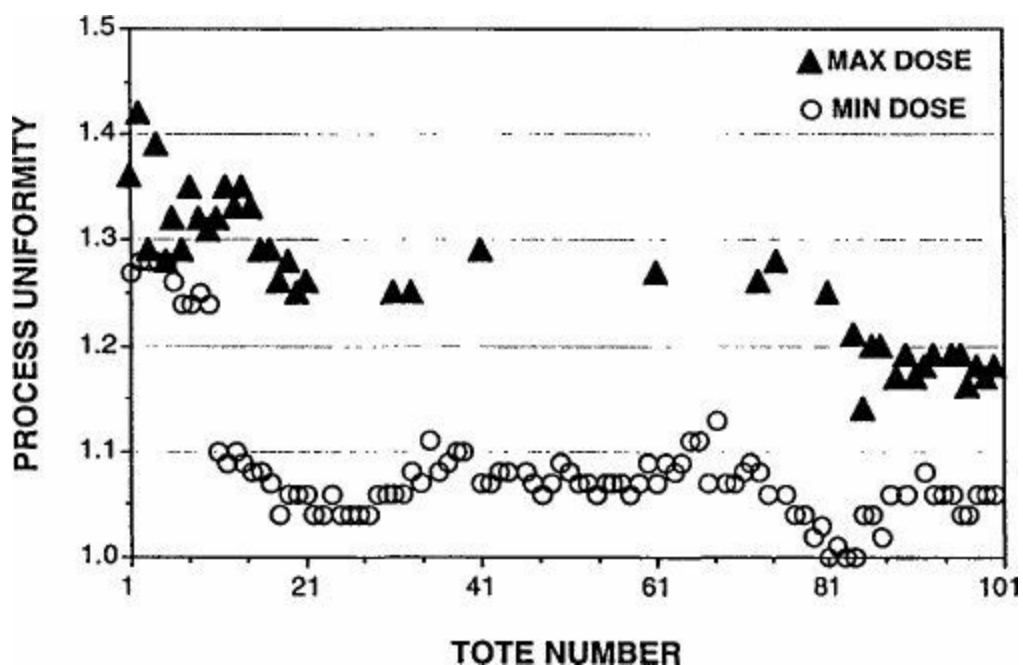

Figure 12. Results of Monitoring Minimum and Maximum Dose on a Per-Tote Basis for a 6-Pass Product-Overlap Gamma Irradiation Facility

## Concluding Remarks

It was noted in a previous Kilmer conference that Dr. Charles Artandi's sterilization studies coincided with a "revolution" in our industry (16). It is submitted to the reader of our paper that we, as sterilization scientists, are again caught up in a revolution of sorts, not one that is localized to the realm of health care but one spanning basic elements of human endeavor related to communication and the proper dissemination of information.

Coordinated, proactive industrial activities and enhanced national standards laboratory interfaces are essential if we are to continue to propagate and expand the utility of radiation sterilization techniques. Given our industry's traits of innovation, introspection, and self-regulation, this will occur.

# References

1. Anderson C. The Rocky Road to a Data Highway. *Science* 1993;260(5111):1064-1065.
2. ANSI. *Software Development and Systems*. New York: American National Standards Institute.
3. ASTM. *Annual Books of ASTM Standards Volume 14.01 (Analytical Methods — Spectroscopy; Chromatography; Computerized Systems)*. Philadelphia: American Society for Testing and Materials.
4. ASTM. *Annual Books of ASTM Standards Volume 12.02 (Nuclear (II), Solar and Geothermal Energy)*. Philadelphia: American Society for Testing and Materials.
5. Brynjolfsson A. Cobalt-60 Irradiator Designs. In: Gaughran ERL, Goudie AJ, eds. *Sterilization by Ionizing Radiation — Volume I*. Montreal: Multiscience Publications; 1974; 145-172.
6. Carlton RR, Adler AM. *Principles of Radiographic Imaging — An Art and a Science*. Albany: Delmar Publishers; 1992.
7. Chapman KG, Harris JR. Computer system validation—staying current; PMA's Computer Systems Validation Committee: Introduction. *Pharm Technol* 1989;13(5):60-66.
8. Cleland MR, O'Neill MT, Thompson CC. Sterilization with accelerated electrons. In: Morrissey RF, Phillips GB, eds. *Sterilization Technologies — A Practical Guide for Manufacturers and Users of Health Care Products*, New York: Van Nostrand Reinhold; 1993; 218-253.
9. Doyle Y, Gibson W. Nordion International Inc., Kanata, Canada. Private communication. May, 1993.
10. Edwards P, Edwards S. BBS start-up basics. *Home Office Computing* 1993; May:18.
11. Gillis JR. Validation of sterilization processes for medical devices. In: Gaughran ERL, Morrissey RF, eds. *Sterilization of Medical Products, Volume II*. Montreal: Multiscience Publications; 1981; 3-10.
12. Herring CM, Saylor MC. Sterilization with radioisotopes. In: Morrissey RF, Phillips GB, eds. *Sterilization Technology — A Practical Guide for Manufacturers and Users of Health Care Products*. New York: Van Nostrand Reinhold; 1993; 196-217.
13. IEEE. Standard for software test documentation. ANSI/IEEE Std 829-1983.
14. ISO 9000 International Standards for Quality Management. Quality management and quality assurance standards — Part 3: Guidelines for the application of ISO 9001 to the development, supply and maintenance of software. 2nd ed. 1991; 103-121.
15. ISO/TAG 4/WG3. Guide to the expression of uncertainty in measurement. First ed. 1992.
16. Masefield J. Advances made in cobalt-60 gamma sterilization. In: Gaughran ERL, Morrissey RF, eds. *Sterilization of Medical Products, Volume II*. Montreal: Mutiscience Publications; 1981; 202-209.
17. McLaughlin WL. Radiation measurements and quality control. *Rad Chem Phys* 1977; 9:147-181.
18. McLaughlin WL, Kahn HM, Farahani M, et al. Low-energy electron dose-distribution measurements with thin-film dosimeters. *beta-gamma* 1991;2+3:20-29.
19. McLaughlin WL, Boyd AW, Chadwick KH, McDonald JC, Miller A. *Dosimetry for Radiation Processing*. New York: Taylor and Francis; 1989.

20. Miastkowski S, Schnapp M. Two roads to windows databases. *Byte* 1993;18(7):136-138.
21. Miller A. Approval and control of radiation processes, EB and gamma. *Rad Chem Phys* 1988;31(1-3):385-394.
22. Nablo SV. Progress toward practical electron beam sterilization. In: Gaughran ERL, Morrissey RF, eds. *Sterilization of Medical Products, Volume II*. Montreal: Mutiscience Publications; 1981; 210-222.
23. Olsson LE, Arndt J, Fransson A, Nordell B. Three-dimensional dose mapping from gamma knife treatment using a dosimeter gel and MR-imaging. *Radiother Oncol* 1992;24:82-86.
24. Pageau G. Titan Scan Systems, Englewood, Colorado, Private communication. May, 1993.
25. Parker JA. *Image Reconstruction in Radiology*. Boca Raton: CRC Press; 1991.
26. PMA's Computer Systems Validation Committee (CSV). Validation concepts for computers used in the manufacturing of drug products. *Pharm Technol* 1986;10(5):24-34.
27. Russ JC. *The Image Processing Handbook*. Boca Raton: CRC Press; 1992.
28. Saylor MC, Tamargo TT, McLaughlin WL, Kahn HM, Lewis DF, Schenfele RD. A thin film recording medium for use in food irradiation. *Rad Chem Phys* 1988;31(4-6):529-536.
29. Saylor MC. Developments in radiation equipment including the application of machine-generated x-rays to medical product sterilization. In: Morrissey RF, Prokopenko YI, eds. *Sterilization of Medical Products, Volume V*. Morin Heights: Polyscience Publications; 1991;327-344.
30. Saunders C. AECL Research, Pinawa, Manitoba. Private communication. May, 1993.
31. Schilling ED. Control charts: A technique of process control. *Med Dev & Diag Ind* 1989;April:46-51.
32. Taylor BN, Kuyatt CE. *Guidelines for Evaluating and Expressing the Uncertainty of NIST Measurement Results*. NIST Technical Note 1297, 1993.
33. Taubes G. Publication by electronic mail takes physics by storm. *Science* 1993;259:1246-1248.
34. Teagarden CJ. A stepwise approach to software validation. *Pharm Technol* 1989;13(9):98-112.
35. Tufte ER. *The Visual Display of Quantitative Information*. Cheshire: Graphics Press; 1983.
36. Tufte ER. *Envisioning Information*. Cheshire: Graphics Press; 1990.
37. USFDA. Guide to Inspection of Computerized Systems in Drug Processing. Rockville, MD: US Food and Drug Administration; 1983.
38. VanZandt W. Scientific visualization: One step in lab analysis workflow. *Advanced Imaging* 1992;February:20-22.
39. Walker ML, Puhl JM, Soares CG, et al. Precision source profiling techniques for ionizing radiation sources. In: *Proceedings of Rad Tech '92 North America*. 1992; April 26-30.



# Diversity of Accelerator Technologies for Medical Product Processing

Theo Sadat, Ph.D. and Allison Ross

*MeV Industries S.A., France*



# Introduction

The only way to introduce energy into a product without significantly increasing its temperature is by using ionization technology. Ionization energy can be obtained in two ways: either by electromagnetic gamma ray or by the energetic electron, also convertible into x-rays. This ionization energy is used to modify molecular structures. In living cells, the molecular bonds are broken leading to destruction of the cell. In chemicals, however, modification can lead either to polymerization or to bond breaking. This energy has applications for sterilization of medical products. The sources of ionization energy are either radioactive Cobalt 60 or an electrical machine — the electron accelerator.

In this paper we shall discuss the different types of accelerators available today, their applications in the medical industry, and the current status of electron beam use in the world.

# Different Types of Accelerators

The accelerator is an electrical machine. When 'on' it produces high energy electrons yet when 'off' is perfectly safe. Electrons are particles with a negative charge which enables them to be accelerated by an electrical field. The higher the energy of the electrons after acceleration, the greater the penetrative power when the electron encounters material. Accelerators can be divided into three categories based on the energy of the output electrons:

- **Low energy accelerators** produce electrons between 100 and 300 keV.
- **Medium energy accelerators** produce electrons between 700 keV (0.7 MeV) and 5 MeV.
- **High energy accelerators** produce electrons with 10 MeV. This is the upper energy limit for industrial electron accelerators.

The machines can be used as a dual assembly, face to face, doubling the product penetration values and thus doubling the throughput.

The principal of operation of low and medium energy accelerators is that of electrostatic acceleration. Electrons are emitted from a filament or series of filaments and are accelerated through a single or multi-step voltage difference. These are continuous current machines.

The high energy machine (10 MeV) uses an alternating electrical field to accelerate the electrons to 10 million volts. The electrons are pulsed with this machine.

In the linear accelerators such as CIRCE and IMPELA, a radio frequency field is used. Other developments (i.e., Rhodotron) use a magnetic field.

Commonly used terminology includes:

- **Electron energy:** the higher the electron energy, the greater the penetrative power. 1 eV is the energy received by 1 electron when accelerated through 1 volt.
- **Power:** the higher the power the greater the throughput. Power is a measure of the electron energy delivered per second. Power 1 J/s = 1 watt. For industrial accelerators, the power is measured in kW.
- **Dose:** the energy absorbed by a material measured in kGy. 1 joule/Kg = 1 kGy.
- **Dose rate:** the rate at which the ionizing dose is received by the material. Measured in unit of dose/unit of time.

## *Low Energy Electron Accelerators*

Low energy accelerators produce electrons in high quantity, i.e., give a high power output and a high dose rate. The machine can be either a continuous current or scanning type. This type of machine is used for surface treatment as the electrons have a maximum penetration of 0.06 cm in a material of 1 g/cm<sup>3</sup>. The high dose is ideal for web products such as paper or material on a roll (web speeds of > 400 m/min at 25 kGy are possible). Sterilization of web medical products (i.e., bandages, wound dressing) is envisaged. These machines are self-shielded and can be easily installed in a factory line process.

The size of this machine can be as little as 2 meters high and 2 meters deep; the width depends on the web size. These machines are supplied by RPC Industries, U.S.A. (12), ESI Industries, U.S.A (23), and POLYMERPHYSIK, Germany (8). Dose depth curves for low energy

electrons are given in Figure 1.

Low energy electron accelerators are used in many other industries. The most notable include food packaging (shrink film), printing (ink drying), and silicone release coatings. Approximately 200 machines are in use worldwide.

### Medium Energy Electron Accelerators

Medium energy electron accelerators use the principle of acceleration between stepped voltage plates. This incremental voltage increase allows up to 5 MeV energy to be achieved. The machines produce a continuous current beam and are comprised of an accelerating column which is insulated by gas and enclosed in a pressure vessel. The beam is scanned over the product. The machine size varies linearly with the energy of the output electron. The penetration of the electrons at 5 MeV is approximately 2 cm in a product density of 1 g/cm<sup>3</sup> for single-sided treatment, 4 cm with double-sided treatment.

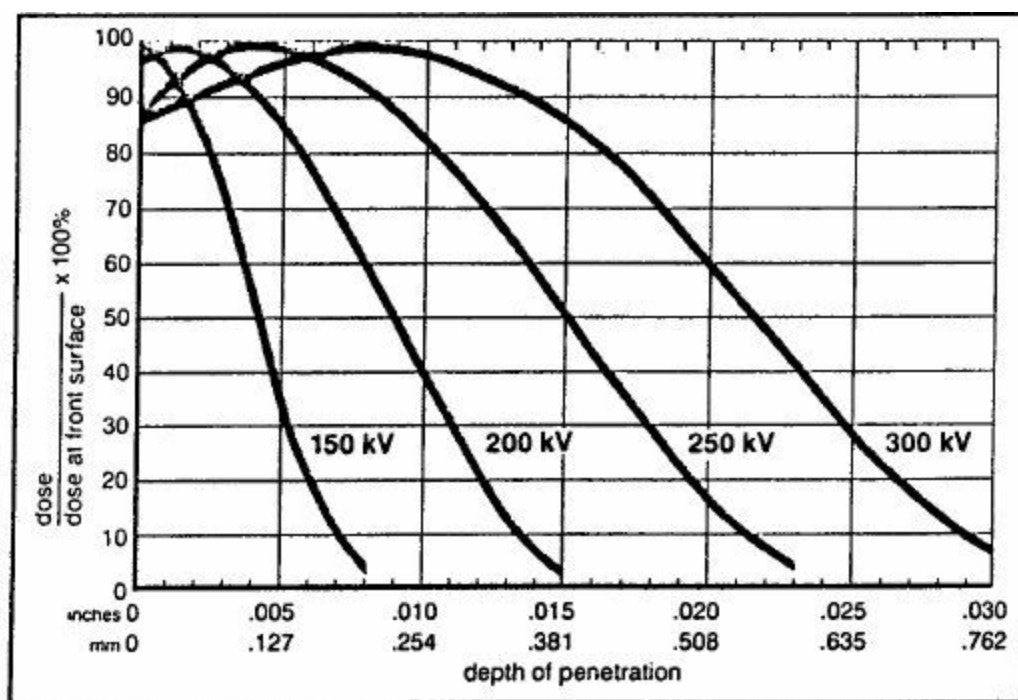

Normalized dose vs. depth for a material with mass density  $\rho = 1.0 \text{ g/cm}^3$ . The incident electron beam has passed through a 0.0006 inch (0.015 mm) thick titanium foil and 1.25 inches (31.75 mm) of air:

(Courtesy of RPC Industries)

Figure 1. Low Energy Electron Beam Dose Depth Curves — Single-Sided Treatment

Normalized dose vs. depth for a material with mass density  $\rho = 1.0 \text{ g/cm}^3$ . The incident electron beam has passed through a 0.0006 inch (0.015 mm) thick titanium foil and 1.25 inches (31.75 mm) of air.

The dose rate is high and the machine is a continuous current type. These machines are used to sterilize medical products either in line (e.g., syringes) or in contract service centers where the products are packed in a suitable manner. Machines using 5 MeV require an installation in biologically shielded housing or 'blockhouse' and concrete walls are necessary. Suppliers of these accelerators include Radiation Dynamics, Inc., U.S.A. (22) and Nissin High

Voltage, Japan (21). Approximately 350 medium energy machines are in use worldwide in industries such as medical sterilization, cable and wire, and tire manufacture. They can also be used to produce x-rays but the conversion efficiency is not sufficiently high enough to give an industrial throughput, especially where the required dose is high (6).

### High Energy Electron Accelerators

High energy electron beam accelerators are used by medical disposable manufacturers for sterilization of their product in the final shipping cases. The 10 MeV electrons have enough energy to penetrate up to 60 cm in a product of density  $0.15 \text{ g/cm}^3$  with double-sided treatment. Dose/depth curves for 10 MeV electrons are shown in Figure 2.

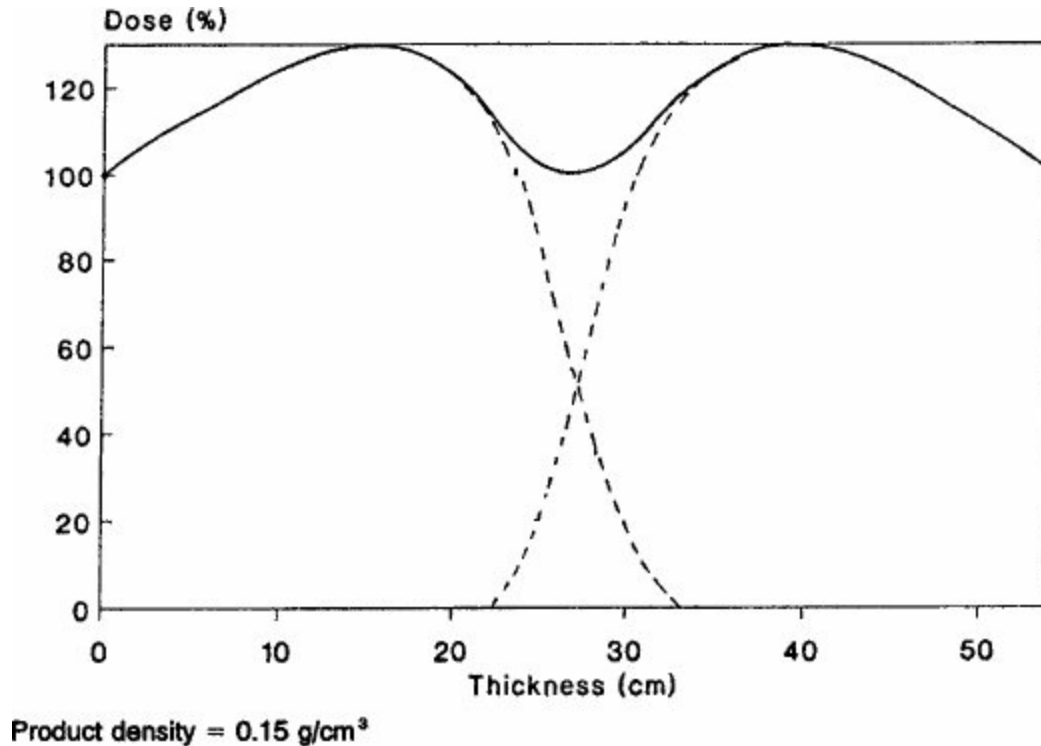

Figure 2. Depth/Dose Distribution Curve — 10 MeV E-Beam — Double-Sided Irradiation

The high energy machines tend to be compact. For example, the RF linac, 10 MeV 20 kW, occupies a floor space of  $7 \times 10$  meters. Figure 3 shows a typical layout of an RF linac. The RF linac comprises an electron gun, an accelerating tube (for 20 kW this is  $\sim 2$  meters long,  $< 0.5$  meters diameter), a modulator, and the scanning assembly and output window. The smaller size in comparison to the medium energy (e.g., 5 MeV) machines is due to the different technology used for accelerating the electrons.

High energy electron machines are used both in-house and at contract service centers. Particular advantages of these machines include high penetration of the electrons allowing full shipping cases to be sterilized; flexibility of product treatment (immediate change product to product); and the speed at which products are treated (product cases treated in seconds). This method of sterilization minimizes work in progress as the product is sterilized in approximately 10 minutes.

The first in-house manufacturing facility to use a high energy electron beam accelerator has been operational since 1992. It is possible to sterilize approximately  $1000 \text{ m}^3$  per working week

with 40 kW of power at this facility. Each product case is sterilized in less than 1 minute. This facility, described in detail in another paper (see “Design and Development of a Unique Electron Accelerator Facility”, Thierry Descamps) is completely computer controlled. All of the machine parameters are fed into a central computer, logged, and are linked to the factory house computer (17).

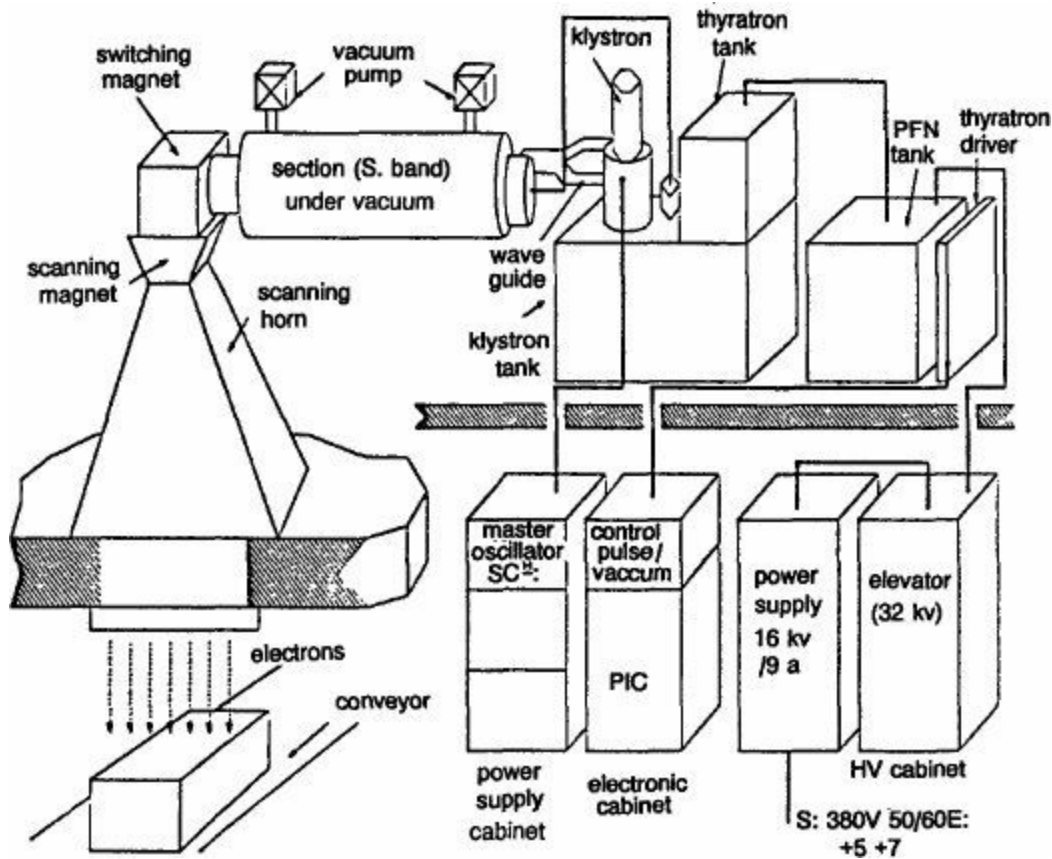

Figure 3. 10 MeV Linac — Typical Layout

There are a number of manufacturers of high energy electron beam accelerators. The current industrial machines are supplied by MeV Industrie, France (18), AECL, Canada (11), Scanditronix, Sweden, and TORIY, Russia. New developments are progressing by IBA, Belgium (10) and TITAN Scan Systems, U.S.A., as well as by others.

# Dose Distribution and Product Validation

The dose distribution in a product depends on the energy of the beam and on the density of the product. In a homogeneous product such as non-woven materials, it is possible to theoretically calculate the dose distribution. Following this the validation of a product is carried out using the dose mapping technique, placing dosimeters throughout the product box (13).

In a heterogeneous product, this dose mapping is very important, as the dose received at points throughout the box depends entirely on the variations in local density. It has been found that high energy electrons can even be used to sterilize items with high local density. For example, hand switching pencils have been sterilized by 10 MeV electrons. For a product comprised of 10 feet of copper cable and the pencil itself (switch, metal, probe), the maximum equivalent density was up to 8 g/cm<sup>2</sup> and average density was 0.2 g/cm<sup>3</sup>. The products are packed five deep in a packing case (see Figure 4). It can be seen from this Figure that good distribution can be achieved even where the product is highly heterogeneous.

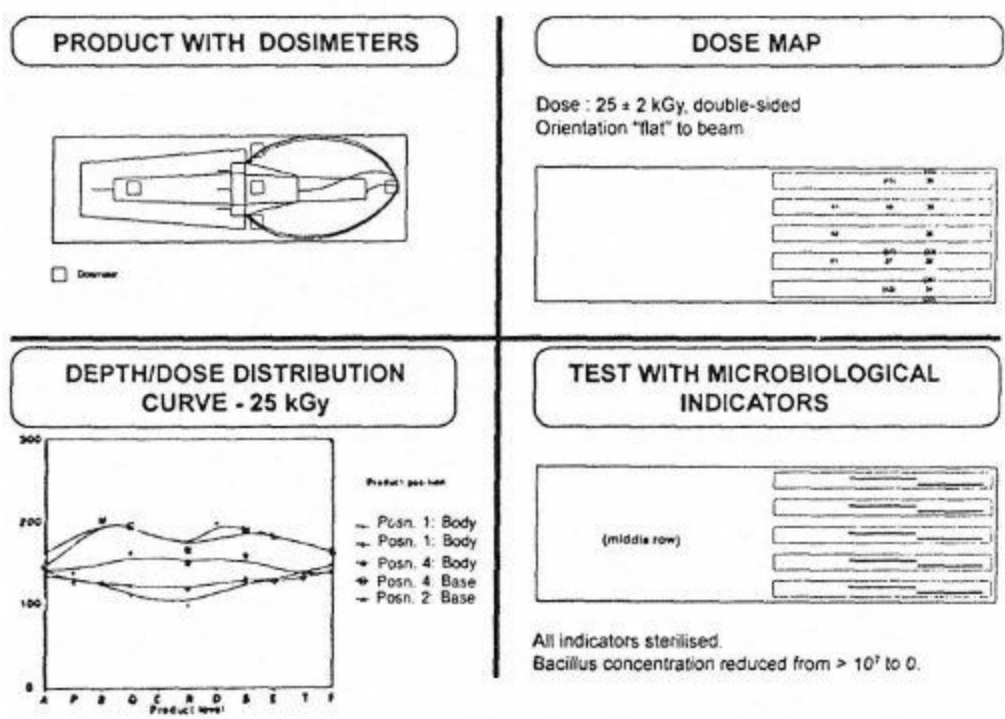

Figure 4. High Energy Electron Beam Used in the Sterilization of a Highly Heterogeneous Product

# Regulations for Electron Beam Sterilization

Many regulations have been finalized or are in the process of being finalized for the use of electrons in sterilization. A current list of regulations is given in Table I.

The regulations and recommended practices have been set by the Association for the Advancement of Medical Instrumentation (AAMI) (1), American National Standards Institute (ANSI) (1), and the International Standards Organization (ISO) (14). ISO has also developed Technical Committee (TC) 198 "Standard for Sterilization" which is currently being circulated for discussion. In Europe, the central body is the European Committee for Standardization (CEN). This body has produced a document for TC 204 for the sterilization of medical devices in which there is a guidance document for each method of sterilization (i.e., ethylene oxide, gamma, electron beam). These documents are currently at the proposal stage (5). Both CEN and ISO have agreed to encourage the transfer of projects from one to the other to ensure efficiency. The CEN is also working with the European Pharmacopoeia Commission (EPC) to rationalize all the independent standards of the individual European countries (i.e., La Pharmacopée Française (châp. IV.6) "Méthodes de Stérilisation" — Ministère de la Santé (15) in France and the U.K. Department of Health's "Quality Systems for Sterile Medical Devices and Surgical Products") (7).

**Table I. Current Status of Several Regulatory Documents for Electron Beam Sterilization**

Organization	Reference	Title	Current Status
International Standards Organization (ISO) (9)	TC 198	Sterilization of Health Care Products	
	Methods for validation and routine control – Gamma and Electron Beam Radiation Sterilization	ISO/DIS 11137 – Discussion document	Proposal: November 1992
European Committee for Standardization (CEN) (5)	CEN 204	Sterilization of Medical Devices	Proposal: November 1992
	prEN 552	Sterilization of Medical Devices – Validation and routine control of sterilization by irradiation	
	prEN 556	Sterilization of Medical Devices – Requirements for medical devices to be labeled 'STERILE'	

European Pharmacopoeia — Commission (EPC)	—	—	Agreement with CEN
Association for the Advancement of Medical Instrumentation (AAMI)/American National Standards Institute (ANSI) (1)	ST 31-1990	Guideline for Electron Beam Sterilization	Approved October 15, 1990 by ANSI
American Society for Testing and Materials (ASTM) (2)	E 10.01 L	Dosimetry for Radiation Processing Standard Practice for Dosimetry in an Electron Beam Facility for Radiation Processing at Energies between 100 and 300 keV	Draft II issued 1993
American Society for Testing and Materials (ASTM) (3)	E 10.01 M	Standard Practice for Dosimetry in an X-Ray (Bremsstrahlung) Irradiation Facility for Radiation Processing	In Draft
American Society for Testing and Materials (ASTM) (4)	E 10.01 T	Standard Practice for Dosimetry in an Electron Beam Facility for Radiation Processing at Energies Between 300 keV and 25 MeV	In Draft
Department of Health — U.K.(7)	GMP	Quality Systems for Sterile Medical Devices and Surgical Products 1990 Good Manufacturing Practice	Approved 1990
(La Pharmacopée Française IV.6 (Ministère de la Santé — France) (15)	—	IV.6 Méthodes de Stérilisation	Approved January 1986
International Atomic Energy Authority (IAEA)	—	—	IAEA offers a Dose Assurance Service (IDAS)

For dosimetry, the American Society for Testing and Materials (ASTM) in the U.S has also produced standards (2-4). The regulations for both electron beam and gamma sterilization are in the final stages both with the ISO and in Europe with the CEN (14,16).



# Dosimetry of Installation

Calibration of radiation doses for sterilization can be performed by calorimetry, aniline, or dichromate. For accelerators, these dosimetry systems can be used as a reference, traceable to a primary standard. The primary standard is a calorimeter; for example, the National Physics Laboratory in the U.K. (NPL) holds such a primary reference. Secondary calibration sources are held at accredited laboratories such as the National Institute for Standards and Technology, U.S.A. (NIST), RISO, Denmark, and NPL, U.K.

## *Routine Dosimetry*

To be able to calculate the dose given with the electron beam accelerator is necessary only to measure beam current, beam energy, and the scanning width. After validation of a product has been completed and the machine parameters established, the dose given to the product will always be identical where the same machine parameters and conveyor speed are used. Dosimeters that are routinely used for product traceability are “Far West Technology” Radiachromic dye, dose range: 0.5 kGy to 200 kGy, PVC and CTA dosimeters, and, at low doses, GAF chromic, dose range: 20 Gy to 300 kGy. The dimension of the dosimeters is also important since the smaller the linear energy transfer (LET), the greater the dosimeter dimension must be. The Radiachromic dye dosimeters used for electron beam are 1 cm<sup>2</sup> with a thickness of 2 mils.

# Installation

Medium and high energy electron beam accelerators are installed in a blockhouse whereas low energy machines are self-shielded. The product is brought to the beam on a standard conveyor. This conveyor is of variable speeds, and the part of the conveyor beneath the scanning horn has to be accurately controllable so that the dose given is regulated as a function of the conveyor speed. Cart conveyor systems are also used in which the track is in the floor. The blockhouse walls can be up to 2.5 to 3 meters thick depending on the energy of the output electrons.

With high and medium energy electron beam accelerators, it is often necessary to have a system for turning over the product boxes. Various systems have been employed at different sites and the technology is simple and well known. Where each product is identified by, for example, a bar code label, the product boxes can be traced throughout the sterilization process. In fact, it is possible for the process to be treated as a pallet process in which a pallet arrives, is depalletized automatically and each box is coded, and the product passes along a conveyor and through the beam for sterilization. At the end of the conveyor the same products are depalletized. The sterilized product therefore has the advantage of good dose distribution within each box and full control of the dose of each product box yet in effect, sterilized “as a pallet”.

It is possible that a dual machine system may be applicable for large production throughput. The machines can be installed so that the product passes between two machines which avoids the requirement of having to turn over the product. Figure 5 displays a dual high energy electron beam system in use at Mölnlycke Waremme.

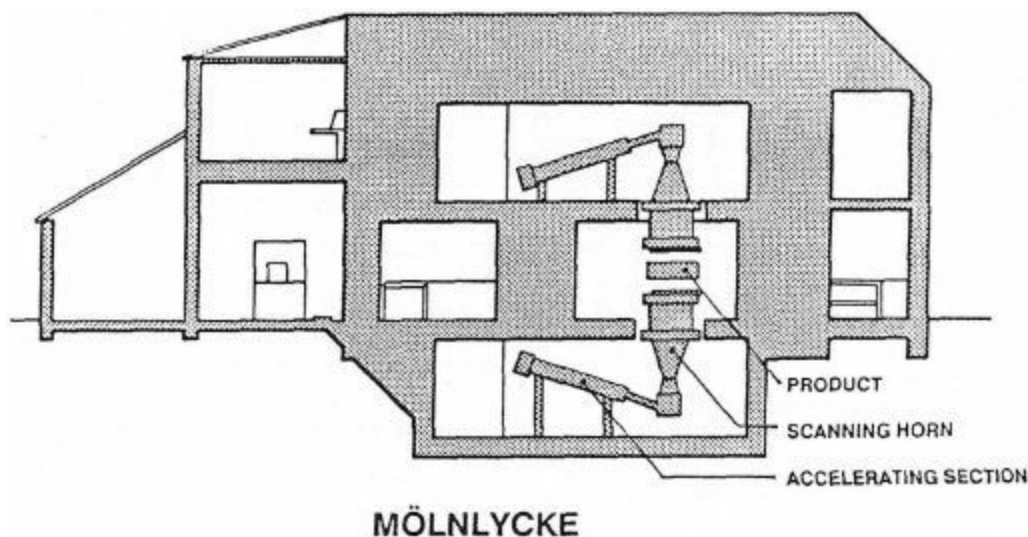

Figure 5. Sterilization Facility Equipped with a Dual High Energy Electron Beam System (Mölnlycke Waremme)

With the target in front of the scanning horn, it is possible to create x-rays from the electron beam. It is a simple operation to place the x-ray target in front of the beam; an operation which takes minutes and can be done automatically. However, the conversion efficiency is low, i.e., the power output of the x-rays is low; the target has to be designed to give the best conversion efficiency and has to be cooled to remove the energy not converted to x-rays.

Hence, the cost of using x-rays is high (6). X-rays are only necessary for high density products of significant thickness. It is therefore envisageable that the combination of electrons and x-rays will give a complete and economic sterilization facility.

### Cost Considerations

Figure 6 shows a cost comparison of the three sterilization processes: high energy electron beam, gamma ray, and ethylene oxide. The comparison was carried out by the Mölnlycke company when making a feasibility study for their new sterilization plant (20). Some major electron beam installations are listed in Table II.

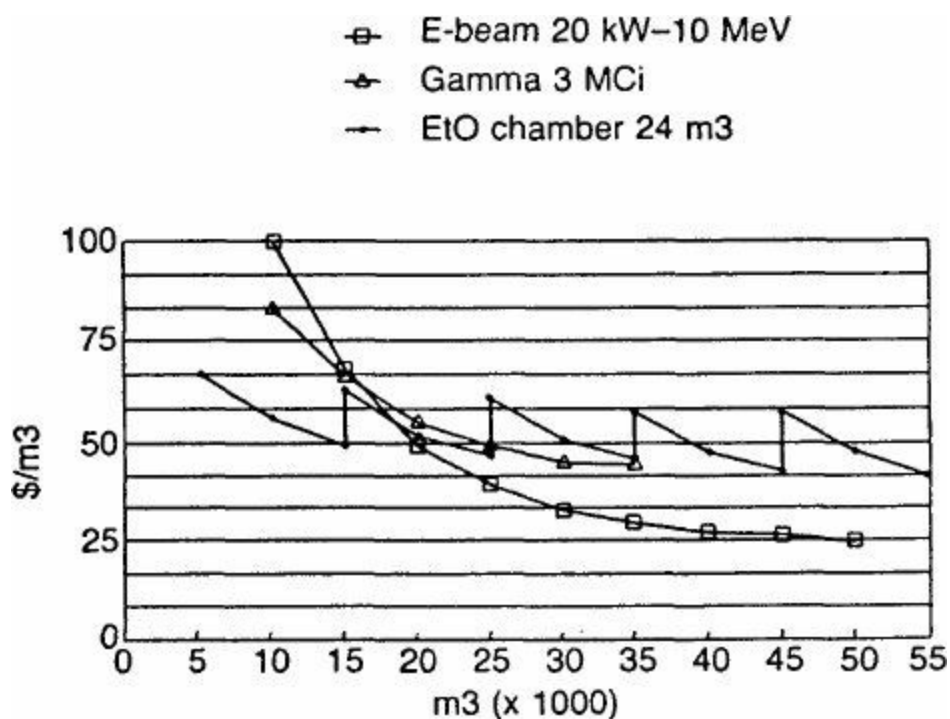

Figure 6. Cost Comparison of the Three Processes (Electron Beam, Gamma Ray, and Ethylene Oxide Sterilization Methods)

Table II. Major Electron Beam Facilities (24)

Contract	In House
<u>10 MeV</u>	
RISO, Denmark	Mölnlycke, Belgium (2 machines)
Caric Orsay, France	SPI, France
Caric Aube, France	Aerospatiale, France
STRIL AB, Sweden	Bundertorschungsanstalt fur Ernährung, Germany
E Beam Services, U.S.A.	Iowa State University, U.S.A.
IRT Corporation, U.S.A.	Irradiation Research Facility — Florida, U.S.A.
	HOGY, Japan
<u>&lt; 5 MeV</u>	
Beta Gamma Service, Germany	
ISOTRON, U.K.	Studer AG, Switzerland

JAERJ, Japan

Radia Industry, Japan

E Beam Services, U.S.A.

Medical Sterilizers Inc., U.S.A.

Polytype SA, Switzerland

3M, Netherlands

Acome, France

Pagendarm, Germany

WKP, Unterensingen

---

# Conclusion

Electron beam sterilization has advanced in the last 10 years to the point where industrial machines are now commonly used by manufacturers. The different types of accelerators (i.e., low, medium, and high) are used for sterilization of medical products in different applications which is determined by the penetrative availability of the output electron. There has been a continuing growth in the uses of these machines for sterilization (see Table II). With the advantages of safety, fast processing, flexibility, and the good distribution of dose, the use of electron beam accelerators, both in-house and at contract facilities, is a real solution for the sterilization of medical products.

# References

1. AAMI. Guideline for electron beam sterilization of medical devices. ANSI/AAMI ST 31-1990. Arlington, VA: AAMI; 1990.
2. ASTM. E10.01 L. Standard practice for dosimetry in an electron beam facility for radiation processing energies between 100 and 300 keV. 1993.
3. ASTM. E10.01 M. Standard practice for dosimetry in an x-ray (bremsstrahlung) irradiation facility for radiation processing. 1993.
4. ASTM. E10.01 T. Standard practice for dosimetry in an E-beam facility for energies between 300 keV and 25 MeV. 1993.
5. CEN. Validation and routine monitoring of sterilization by irradiation, prEN 552. Brussels: European Committee for Standardization; 1992. Sterilization of medical equipment. Requirements for labeling "STERILE", prEN 556. Brussels: European Committee for Standardization; 1992.
6. Cleland MR et al. X-ray processing — a review of status and prospects. 8th IMRP, China. September 1992.
7. Department of Health — U.K. Quality systems for sterile medical devices and surgical products. Good Manufacturing Practice. London: HMSO; 1990.
8. Holl P, Foll E. Electron beam for controlled environmentally friendly through-curing of lacquers, foils and adhesives. Radtech Europe. May 1993.
9. ISO. Sterilization of health care products — validation and routine control — TC 198 gamma and electron beam radiation sterilization. ISO/DIS 11137. Geneva, Switzerland: ISO; 1991.
10. Jongen Y et al. The Rhodotron: A new electron accelerator for industrial use. Radtech North America. April 1992.
11. Kerluke DR, McKeown J. The commercial launch of IMPELA. 8th IMRP, China. September 1992.
12. Klein A. New developments in electron beam processors and processing. Nitzl Conference, Germany. October 1992.
13. Miller A. Validation of products for radiation sterilization. 8th IMRP, China. September 1992.
14. Miller M. AAMI national and international standards program. In: Morrissey RF, Prokopenko YI, eds. *Sterilization of Medical Products, Vol. V*. Morin Heights: Polyscience Publications Inc; 1991; 104-118.
15. Ministère de la Santé — France. La Pharmacopée Française IV.6. Méthodes de Stérilisation. 1986.
16. Mukherjee RN. IAEA standards applicable for sterilization. In: Morrissey RF, Prokopenko YI, eds. *Sterilization of Medical Products, Vol. V*. Morin Heights: Polyscience Publications Inc; 1991; 119-124.
17. Sadat T, Morisseau D, Ross A. Computer control of linear accelerator processing in a medical facility. Radtech North America. April 1992.
18. Sadat T, Ross A, Pass S. Radiation techniques high energy industrial applications of electron beam processing. Radtech North America. April 1992.

19. Sadat T, Ross A. Electron beam sterilization of heterogenous medical devices. 8th IMRP, China. September 1992.
20. Sadat T. Dual linear accelerator system for use in sterilization of medical disposable supplies. Nucl Inst and Methods in Phys Res B 56/57. 1991; 1226-1228.
21. Taniguchi et al. A 5 MV 3 MA EB/X-ray processing system. 8th IMRP, China. September 1992.
22. Thompson CC. A new high-current dynamitron accelerator for electron beam processing. 8th IMRP, China. September 1992.
23. Zaino DC, Nablo S, Rangwalla IJ. Hybrid inerting of selfshielded electron beam processors. Radtech North America. April 1992.





# AAMI Dose Setting: Ten Years Experience

Joyce M. Hansen

*Baxter Healthcare Corporation, U.S.A.*

Ionizing radiation has been utilized for the sterilization of medical devices for the past 30 years and the question of what sterilization dose to use has always been a concern. For many years, several European countries have required a dose of  $\geq 25$  kilogray (kGy) provided that the device bioburden does not exceed an agreed upon maximum.

A major limitation of the radiation sterilization process is the radiation damage that can occur in materials; therefore, it is important that excessive sterilization doses be avoided. Because of this limitation, some medical device manufacturers in North America have felt that it was important to determine the sterilization dose that was required to achieve the desired sterility assurance level (SAL) for an individual medical device. Therefore, in 1976, the Association for the Advancement of Medical Instrumentation (AAMI) Radiation Working Group began developing guidelines to allow for the calculation and validation of sterilization doses.

The model evaluated by Tallentire (12,16-19) which related the frequency of contaminated items after exposure to increasing amounts of radiation, was the basis for the development of the AAMI dose setting methods. The AAMI Radiation Working Group developed the dose setting methods over a period of 8 years. During that time the dose setting methods went through several revisions based upon the results of computer simulations and actual use by AAMI members (4,5,10,13-15,21). The AAMI radiation guideline, which contained Methods B.1, B.2, B.3, and B.4, was published in 1984 (1).

# Experience with AAMI Dose Setting Methods

In 1989, the radiation guidelines were scheduled for revision as part of the normal 5-year AAMI review process. The Radiation Working Group reconvened and issued a call for comments to determine if the guidelines needed revision. In addition, it was decided that data obtained from the use of the AAMI dose setting methods was needed in order to review the results of their application by industry and to adduce evidence that might support their appropriateness or indicate the need for modifications. To accomplish this, a questionnaire was prepared and distributed to members of the Radiation Working Group. Receipt of replies was handled anonymously through the AAMI office. James Whitby, M.D., of the University Hospital at the University of Western Ontario, Canada, and I have finished the analysis of the results and they have been submitted for publication (9). Various aspects of the analysis are presented here.

Replies to the questionnaire were received from 18 manufacturers with information on the dose setting experience for 92 devices. A summary of the types of devices on which information was received is contained in Table I. The majority of devices were either plastic or plastic with another material such as metal or wire. It was interesting to note that all of the devices that contained a bioburden in excess of 1,000 colony forming units (CFU) per device were natural products and four of the nine devices that contained a bioburden between 100 to 1,000 CFU per device were natural products.

**Table I. Summary of Devices**

Category	No. of Devices
Plastic	41
Plastic & Other	18
Cellulosics	9
Glass & Rubber	5
Metal	4
Water Cup	2
Other	13

AAMI dose setting methods B.1 and B.2 were used for the majority of the devices (81.5%); those devices that were intended for distribution in Europe, where a minimum sterilization dose of 25 kGy is required, were validated by other methods (Table II). After the initial validation, AAMI dose setting methods B.1 and B.2 require the irradiation of 100 product units at a  $10^{-2}$  SAL dose on a periodic basis to verify that the sterilization dose is still valid over time. This test is commonly referred to as an audit. After irradiation, the 100 product units are sterility tested in culture media and incubated at 28-32°C for 14 days. If the sterility test results are acceptable (i.e., 2 positives per 100 product units), the sterilization dose at the appropriate SAL is still valid.

**Table II. AAMI Method Used For Sterilizing Medical Devices**

	No. of Devices
--	----------------

Method	(N = 92)
B.1	38
B.2	37
B.1 & B.2 Combined	3
B.4	2
Other	12

As shown in Table III, the majority of devices were tested quarterly and those devices that were not validated with an AAMI dose setting method were also not tested after irradiation to a  $10^{-2}$  SAL dose on a periodic basis.

**Table III. Audit Frequency**

Audit Frequency	No. of Devices (N = 92)
Annual	19
Semi-Annual	2
Quarterly	55
Monthly	1
Not Tested	15

There were a total of 806 audits, using 100 product units for each audit, performed at the  $10^{-2}$  SAL verification dose which ranged from 0.4 to 14.6 kGy. Of the 806 audits performed, only 18 (2.2%) failed to verify the  $10^{-2}$  SAL (i.e., > 2 positives per 100 product units). Including the 18 audits that failed, the overall number of observed positives was 357 in 80,600 product units tested (0.44%). Based on the audit frequency and the number of tests reported, there were 20 devices that had been tested on a quarterly basis over a period of time in excess of 3 years, of which eight devices had been tested over a period of 5 years with acceptable results. In addition, there were five devices that had been tested on an annual basis for 3 years with acceptable results (Table IV). Thus, these data indicate that AAMI dose setting methods can be used successfully over an extended period of time. These results also provide evidence to support the continued use of Population C for Method B.1 as a population of microorganisms that is equal to or exceeds the normal bioburden resistance distribution.

**Table IV. Audit Frequency and Number of Devices Tested**

Method	Audit Frequency	Time Span (Years)	No. of Devices
B.1	Annual	3	5
		2	4
B.1	Quarterly	>5	3
		3-5	5

		1-3	4
B.2	Quarterly	>5	5
		3-5	7
		1-3	12

Audit and SAL doses from the newly created Method 1 were calculated based on the average bioburden reported; these were then compared to the audit and SAL doses from the old Method B.1 reported by the device manufacturers. The comparison indicated that the majority of the users had been able to correctly determine the audit and SAL doses. There were a few instances, however, where it was obvious that the audit and SAL doses had been incorrectly calculated. In addition, it was noted that some audit and SAL doses had been calculated for products with an average bioburden of < 2 CFU (i.e., there were doses calculated which were less than the limits of the Method B.1 tables). This indicated the need for expansion of the Method B.1 tables to provide audit and SAL doses for average bioburdens of < 2 CFU.

Similarly, the new Method 1 audit and SAL doses were calculated based on the average bioburden reported and were compared to the old Method B.2 audit and SAL doses reported by the device manufacturers. The comparison provided some interesting information (Table V). For an average bioburden of < 10 CFU, the calculated Method 1 SAL dose was on average 2 kGy less than the actual Method B.2 SAL dose, and the difference in dose ranged from -4.9 to 0.7 kGy. This difference in dose could potentially be attributed to one or more causes:

- 1) an underestimation of the bioburden on the product;
- 2) an overestimation of the DS value (i.e., the estimated  $D_{10}$  value of the bioburden) due to the low number of contaminated items;
- 3) the overestimation of the DS value due to the minimum  $D_{10}$  value allowed (i.e., 1.6 kGy for Ultra Clean products or 2.0 kGy for all other products); or
- 4) the presence of resistant organisms in very low numbers.

**Table V. Average Bioburden and Comparison of Dose**

Average Bioburden (CFU)	Comparison of Dose
< 10	Method 1 < Method B.2
10-1,000	Method 1 = Method B.2
> 1,000	Method 1 > Method B.2

For an average bioburden > 10 and < 1,000 CFU, the calculated Method 1 SAL dose was generally equal to the Method B.2 SAL dose and the difference in dose ranged from -2.9 to 3.0 kGy. For an average bioburden > 1,000 CFU, however, the calculated Method 1 SAL dose was, on average, 2 kGy more than the actual Method B.2 SAL dose and the difference in dose ranged from -2.7 to 8.9 kGy. This difference in dose could potentially be attributed to two causes:

- 1) a potential overestimation of the bioburden on the product; or

2) the presence of a large number of organisms which have a resistance lower than Population C.

The SAL doses that were determined through the use of Methods B.1 and B.2 were less than 25 kGy. It should be noted, however, that there were a few products, currently sterilized at a  $10^{-3}$  SAL dose, that would exceed 25 kGy if sterilized at a  $10^{-6}$  SAL dose.

# Revisions to the AAMI Dose Setting Methods

As industry experience in using the AAMI dose setting methods has increased, many have suggested ways in which the AAMI dose setting methods might be improved (3,6,7,11,20). AAMI recently released a revised and updated version of its guidelines which incorporated many of these suggestions (2) and a discussion of a few of the revisions follows (8).

The basic structure of the document has changed in that the four dose-setting methods which were incorporated in Appendix B of the 1984 document (B.1 through B.4) have been renamed Methods 1 and 2 since they were moved from an appendix into the main text of the revised guideline. Although Methods B.3 and B.4 are still acceptable, they were not included in the revised guidelines because they have not been commonly used in the industry as evidenced by the survey. Method 3, as included in the revised guideline, is an entirely new method unrelated to any of the methods in the 1984 AAMI guidelines. This new method was specifically designed to address sterilization concerns related to small-volume production processes and clinical trials.

## *Method 1*

Method 1 is typically referred to as the bioburden method because it requires a determination of the product's bioburden — the number of viable microorganisms on the product prior to sterilization. Method 1 remains essentially unchanged in this requirement and provides the means by which the sterilization dose is determined. Bioburden is estimated using 10 product units from each of three lots in this method. A verification dose sufficient to sterilize the product's estimated bioburden to a SAL of  $10^{-2}$  is then determined. This is accomplished by using tables that provide verification doses appropriate for a theoretical bioburden resistance distribution. This is intended to represent a more resistant bioburden than is typically found on devices. This theoretical bioburden resistance distribution is called Population C.

Testing of the verification dose is performed using 100 product units which are subsequently tested for sterility. If the sterility tests are acceptable, a sterilization dose at the appropriate SAL can be determined using the same theoretical bioburden resistance distribution as for the verification dose.

For Method 1, the revised guidelines introduce a thorough revision of the tables used to determine verification and sterilization doses. In the 1984 guidelines, considerable interpolation was required to determine the verification and sterilization doses for intervening bioburden values not included in the tables. This may account for the incorrect determinations of verification and SAL doses that were observed in the survey. The revised guidelines, however, address this difficulty by creating tables in which both estimated product bioburden and SALs can be referenced to determine the verification and SAL doses, thus eliminating the need for interpolation. In addition, the new tables include bioburden levels  $< 2$  CFU and  $> 1,000,000$  CFU (i.e., doses which exceed 25 kGy).

As stated earlier, both dose setting Methods 1 and 2 require the irradiation of 100 product units at a  $10^{-2}$  SAL dose on a periodic basis to verify that the sterilization dose is still valid over time. After irradiation, the 100 product units are sterility tested in culture media and incubated at 28-32°C for 14 days. If the sterility test results are acceptable, the sterilization dose at the appropriate SAL is considered valid.

This audit procedure has been revised to require a quarterly audit of 100 product units. The 1984 AAMI guidelines stated that an audit “should be performed every three months, unless bioburden data indicate otherwise” (1) — intending that quarterly audits should be performed unless the bioburden data indicated that it should be conducted more often. However, many manufacturers interpreted this to mean that quarterly audits need not be performed if bioburden data are acceptable. Initial validation of the sterilization dose is conducted using only three production lots that do not include seasonal variations. The rationale for the AAMI requirement of quarterly auditing is intended to ensure that seasonal changes do not have an impact on the acceptability of the SAL dose.

In the 1984 AAMI guidelines, augmentation of the audit and SAL dose was required when unacceptable test results were observed with an audit. The amount of augmentation was accomplished by using a table that provided the amount based upon the number of positives observed and the sample item portion (SIP) of the device tested. In the revised guidelines, the augmentation of the audit and SAL dose is calculated based upon the number of sterility positives observed and bioburden test results.

### *Method 3*

As indicated earlier, Method 3 is an entirely new method which was specifically designed to address sterilization concerns related to small-volume production processes or clinical trials. This method can be used for small-volume production lots of < 1,000 products, for a single lot manufactured to fill a special order or for a clinical trial, or for release of the first lot of production. Use of the method is limited to products that have a bioburden of < 1,000 CFU.

Method 3 is a derivation of Method 1 and therefore follows essentially the same procedure. Estimation of bioburden is required as well as determination of a verification dose through the use of a theoretical bioburden resistance distribution (Population C, the same as that used for Method 1). For Method 3, the number of product units required to determine the bioburden and to conduct the verification test are based upon the size of the production lot and allows for the use of sample sizes which are less than those used for Method 1.

The verification test is performed using the appropriate number of product units and after irradiation at the verification dose the product units are sterility tested. If the sterility test results are acceptable (i.e., < 1 positive per the number of product units tested), then a  $10^{-6}$  SAL dose of 25 kGy is deemed acceptable.

## Other Topics

The new AAMI guidelines state that, "The use of biological indicators (BI's) for validation and process monitoring, or the use of sterility testing for release of product, are not recommended practice for radiation sterilization" (2). Biological indicators are not recommended for validation and process monitoring of radiation sterilization. This is primarily due to the existence of many organisms that have a higher resistance to radiation than the typical radiation biological indicator which contains spores of *Bacillus pumilus*.

The use of sterility testing is not recommended for release of radiation sterilized product predominantly due to the statistical significance of the sample size used for sterility testing. The typical sample size for sterility testing is 20 product units, which is sufficient only for demonstrating that the product has received a sterilization dose resulting in an SAL of  $10^{-1.3}$  (i.e., the log of 1/20). To substantiate a SAL of  $10^{-6}$  using a sterility test a minimum sample size of one million units would be required.



# Conclusion

In the past, a radiation sterilization dose of 25 kGy was considered to be an adequate Overkill Dose. As evidenced by the survey, there are products that would require doses in excess of 25 kGy to achieve a  $10^{-6}$  SAL. Therefore, the use of 25 kGy as an Overkill Dose is no longer acceptable without validation to prove the achievement of the desired SAL.

The AAMI dose setting methods are recommended practices developed for use with the majority of medical devices although there may be situations where other methods may be more appropriate. In addition, with continued use of the AAMI dose setting methods, the medical device industry may identify refinements of the methods and new procedures that will, in turn, become accepted industry practice. Some of the refinements that have already been identified and are currently being explored are:

- 1) Methods 1 and 2 — the reduction of the sample size required for an audit (i.e., 100 product units) and the frequency of audits (i.e., quarterly);
- 2) Method 2 — the reduction of the sample size required for the incremental doses (i.e., 20 product units);
- 3) Method 3 — the reduction of the sample size required for bioburden and verification testing;
- 4) Method 3 — the use of a more resistant population of isolates, for example, Population D (2), in place of Population C for determination of the verification dose; and
- 5) All Methods — guidance on how to determine product family categories to allow for the determination of a sterilization dose for a group of products as opposed to each individual product.

Although there are several refinements which have already been identified for the AAMI dose setting methods, the survey indicates that Methods 1 and 2 have been used with acceptable results over many years. The next step will be to gather information about the acceptability of the refinements that have been identified, or other refinements, and to gather data on the use of Method 3.

# References

1. Association for the Advancement of Medical Instrumentation. Process control guidelines for gamma radiation sterilization of medical devices. AAMI RS-3/84, Arlington, Virginia: AAMI; 1984.
2. Association for the Advancement of Medical Instrumentation. Guideline for gamma radiation sterilization. ANSI/AAMI ST32-1991, Arlington Virginia: AAMI; 1992.
3. Darbord JC, Laizer J. A theoretical basis for choosing the dose in radiation sterilization of medical supplies. *Inter J Pharm* 1987;37:1-10.
4. Davis KW, Strawderman WE, Masefield J, Whitby JL. DS gamma radiation dose setting and auditing strategies for sterilizing medical devices. In: Gaughran ERL, Morrissey RF, eds. *Sterilization of Medical Products*, Volume 2. Montreal, Canada: Multiscience Publications, Ltd.; 1981; 34-102.
5. Davis KW, Strawderman WE, Whitby, JL. The rationale and a computer evaluation of a gamma irradiation dose determination method for medical devices using a substerilization incremental dose sterility test protocol. *J Appl Bact* 1984;57:31-50.
6. Genova TF, Hollis RA, Crowell CA, et al. A procedure for validating the sterility of individual gamma radiation sterilized production batches. *J Par Sci Tech* 1987;41 1):33-36.
7. Genova TF, Hollis RA, Crowell CA, et al. A procedure for supplementing the AAMI B1 Method for validating radiation sterilized products. *J Par Sci Tech* 1987;41(4):126-127.
8. Hansen JM, Shaffer HL. A guide to revised AAMI methods for radiation sterilization. *Med Dev Diag Ind* 1993;15(1):108-119.
9. Hansen J, Whitby JL. Gamma radiation sterilization practice in the U.S.A. (submitted to *J Applied Bact*, May 1993).
10. Herring CM. Radiation sterilization at American Hospital Supply Corporation. *Radiat Phys Chem* 1979;14:55-59.
11. Herring CM, Owens WM. Experiences with the AAMI dose-setting methods for gamma sterilization. *Med Dev Diag Ind* 1984;6(6):50-55.
12. Khan AA, Tallentire A, Dwyer J. Quality assurance of sterilized products: Verification of a model relating frequency of contaminated items and increasing radiation dose. *J Appl Bact* 1977;43:205-213.
13. Masefield J, Davis KW, Strawderman WE, Whitby JL. A North American viewpoint of selection of radiation sterilization dose. In: Gaughran ERL, Goudie AJ, eds. *Sterilization of Medical Products by Ionizing Radiation*. Montreal, Canada: Multiscience Publications Ltd; 1978; 322-330.
14. Masefield J, Owens WM. Current North American practices in gamma sterilization. In: Harris LE, Skopek AJ, eds. *Sterilization of Medical Products*, Volume 3. Australia: Johnson & Johnson Pty. Ltd.; 1982; 290-311.
15. Summary of the AAMI Intercompany Experiments, Memo to AAMI participants to summarize data. 1/10/80.
16. Tallentire A, Dwyer J, Ley FJ. Microbiological quality control of sterilized products: Evaluation of a model relating frequency of contaminated items with increasing radiation treatment. *J Appl Bact* 1971;34:521-534.

17. Tallentire A. Aspects of microbiological control of radiation sterilization. *Int J Radiat Ster* 1973;1:85-103.
18. Tallentire A, Khan AA. Tests of the validity of a model relating frequency of contaminated items and increasing radiation dose. In: *Radiosterilization of Medical Products 1974*. Vienna, Austria: International Atomic Energy Agency; 1975; 3-14.
19. Tallentire A, Khan AA. The sub-process dose in defining the degree of sterility assurance. In: Gaughran ERL, Goudie AJ, eds. *Sterilization of Medical Products by Ionizing Radiation*. Montreal: Multiscience Publications Ltd; 1978; 65-80.
20. van Asten J. The reliability of dose setting systems. *Radiat Phys Chem* 1990;35(1-3):361-363.
21. Whitby JL, Gelda AK. Use of incremental doses of cobalt 60 radiation as a means to determine radiation sterilization dose. *J Par Drug Assoc* 1979;33:144-155.



# DISCUSSION

## Radiation Sterilization

## **Comments by Dr. Tallentire, University of Manchester, U.K.:**

The contribution and role of Johnson & Johnson in pioneering radiation sterility for medical products has been acknowledged at this meeting. Since that time there has been an almost exponential expansion of the process to a point where radiation sterilization is now considered by some to be a mature industry. As seen today, this maturity has not stifled innovation. Four of the papers presented during this session were typical of the innovative thrust — two were related to process technology, while the other two were related to process control. The fifth paper presented in this session updated us on the use of techniques for dose selection. This is particularly timely since the draft CEN standards which have been produced for sterilization by radiation permits the use of AAMI dose setting methods as one option for selecting a sterilizing dose. The bulk of experience using the AAMI dose setting methods resides in the U.S. and North America and there is very little experience in Europe. It has been extremely revealing to me to get an insight and glimpse into where these methods are going.

## **Question for Mr. Saylor, Virginia, U.S.A.:**

I was somewhat concerned about your remark that there are some aspects of radiation sterilization that are unique. One of the problems with radiation sterilization is general acceptance. We regard it as unique yet I do not think that it is. Is what we are doing in radiation sterilization truly unique or do we expect the same type of control for heat and ethylene oxide sterilization?

## **Answer by Mr. Saylor:**

From my perspective, the aspect of radiation sterilization that makes it unique is the fact that it is very easy, relative to the other forms of sterilization techniques, to make an enormous number of direct measurements of energy deposition, i.e., the measurement of process lethality.



## **Question for Ms. Hansen, Baxter Healthcare Corporation, U.S.A.:**

What method do you recommend for prosthetic implants and expensive products manufactured in limited quantities?

## **Answer by Ms. Hansen:**

Method 3 was developed for this purpose because it uses relatively small sample sizes.

## Question for Ms. Hansen:

If you look at the manufacturing of products of less than 1000 products per lot down to as low as seven products per lot, how many samples should you monitor?

## **Answer by Ms. Hansen:**

The minimum number of samples that we came up with was three for bioburden and three for resistance testing. If that number of sample sizes is still too high, perhaps a family grouping of products can be prepared. Also, a replacement for the implant may be able to be developed as a control that can go through the regular manufacturing process and be used to test for bioburden and for resistance. In addition, we are continuing to improve Method 3.

## **Comment by Dr. Tallentire to Ms. Hansen:**

Method 3 is performed to estimate a sterilizing dose from a smaller number of samples and as of yet has not been tested in the world. In using this method, one should realize that in going from a verification dose with Method 1 of  $10^{-2}$  to as little as  $10^{-1}$ , sensitivity will be lost in determining the sterilizing dose. Therefore, are you giving the appropriate guidance that you should be by using this particular method?

## Answer by Ms. Hansen:

One of the things that we took into account in developing the methodology was the fact that there would be potential loss in the determination of what the true resistance is. This was done primarily from the standpoint that when assessing products such as implants, the bioburden may be less than 5 or 10 CFU per item. The basis for the actual sterilization dose is based on 1000 CFU per item, however. We have taken that into account when we were trying to develop Method 3 and we believe that it does give you an actual sterilization dose which can provide a sterility assurance level of  $10^{-6}$ .

## Question for Ms. Hansen:

What is the track on Method 3? Are clean devices more apt to fail than high bioburden devices for the verification test?

## **Answer by Ms. Hansen:**

We have already observed this situation with the methodology due to the fact that we are dealing with a very low number of samples. We are currently looking at changing Method 3 to use Population D, instead of Population C, because it is a much more resistant organism population to test against.



## Question for Ms. Hansen:

Do you consider the uncertainty by which a given sterilization dose calculated by AAMI methods is measured?

## **Answer by Ms. Hansen:**

Because of the way in which the verification tables were constructed, especially for Method 1, we have taken it to the extreme where we have doses set in 10th kGy. There is a set variable tolerance that is allowed in irradiating the sublethal doses, but it is a very tight tolerance. You can meet those tolerances if you utilize a very well-controlled cobalt facility. In some instances when we have tried to transfer this dose setting method to electron beam processing, we have been very successful in meeting those uncertainty measurements.

## **Question by Dr. Tallentire to Ms. Hansen:**

In moving from the AAMI methods of 1984 to the AAMI methods of 1989, the tolerances have been widened. What is the impact of the tolerance changes on the determination of the sterilization dose?

## Answer by Ms. Hansen:

The change in tolerance was from  $\pm 0.5$  kGy to  $\pm 1$  kGy, which was primarily due to the computer simulations that were performed prior to the 1984 method being issued. A comparison utilizing the population resistance distribution and different bioburden levels was performed to determine what kinds of results would be obtained. There did not appear to be any difference between the use of an uncertainty of  $\pm 0.5$  or  $\pm 1$  kGy. The other reason for the change was the difficulty in many instances for some laboratories to meet the  $\pm 0.5$  kGy tolerance level.

## **Question for Ms. Hansen:**

We have a large number of difficult product types which are gamma irradiated for which the doses have been validated according to former AAMI Method B-1. Revalidation has been done once a year due to the fact that we would come into a serious capacity problem if we did it on a quarterly basis.

## **Answer by Ms. Hansen:**

One aspect of the AAMI dose setting methods which is being examined is the need for periodic frequency on a quarterly basis. This is primarily due to the fact that we assume that additional data are not available to support or maintain the sterilization doses over time. If a company had 3 to 5 years of quarterly auditing data, they would probably not need to continue to do quarterly auditing but could possibly continue to do bioburden monitoring and perhaps perform annual audits. Companies that have a large variety of products manufactured in the same environment from the same types of materials can combine them into one product category, determine a sterilization dose for that product category, and maintain that over time. That would be a way for companies who have a large number of products to continue to validate their sterilization doses.

## Question for Ms. Hansen:

Dose setting Method 1 depends on measurement of bioburden which is governed to a large degree by the accuracy of the bioburden determination. Isn't there a need for controlled and defined methods of bioburden determination?

## **Answer by Ms. Hansen:**

AAMI has instituted a Microbiological Technology Information Report that is to be used in conjunction with the AAMI dose setting methods. Appropriate bioburden methodologies must be developed and there are validation methods incorporated into the Microbiological Technology Information Report. These methods are the same as those currently being developed by the ISO working group.



## Question for Mr. McLaughlin, National Institute of Standards and Technology, U.S.A.:

The British National Physical Laboratory and the French counterpart, LMRI, have set an upper limit of 50 kGy for their transfer alanine dosimeters. It's generally accepted that alanine dosimeters can be used up to  $10^{-5}$  Gy. Why this discrepancy?

## **Answer by Mr. McLaughlin:**

The response curve begins to lose linearity below 50 kGy and approaches saturation at about 200 kGy. Thus, the shape of the curve causes the precision to be greatly diminished. I failed to mention that in the region of doses where validation takes place, the system is linear and it does fill the void of measuring doses between 0.5 kGy and sterilization doses of 25 kGy.

## **Question for Mr. Sadat, MeV Industrie, S.A., France:**

What changes in product configuration for packaging need to be made when changing from ethylene oxide to E beam sterilization?

## **Answer by Mr. Sadat:**

I believe that when changing from ethylene oxide to E beam sterilization the number of products in the box is increased and therefore 10 to 15% of volume is saved.

## **Question Mr. Sadat:**

What techniques are used to control the ozone and nitrogen oxide product in the radiation room with a high power facility to comply with environmental regulations?

## **Answer by Mr. Sadat:**

The ozone inside of the facility can be removed down to a concentration of less than 1 ppm. The technique is only dilution. A pump with 60,000 cubic meter per hour will change all the volume inside the radiation room about 6 times per hour.

**General Discussion**  
**Robert F. Morrissey**  
*Johnson & Johnson, USA*





# GENERAL DISCUSSION

## **Question for Dr. Korczynski, Abbott Laboratories, U.S.A. and Dr. Enzinger, Upjohn Company, U.S.A.:**

Would you please define media fill. Is this only the filling process or does it include all manufacturing steps from compounding to closure of the containers for aseptically manufactured products?

## **Answer by Dr. Korczynski:**

Wherever possible, a media fill should try to encompass the entire operation from the batch process through filling to capping.

## **Answer by Dr. Enzinger:**

At Upjohn, we try to have an exact simulation of the manufacturing process so we take the media fill through the filtration process. We hold the media in a manufacturing tank for 14 days and then check to see if the media fill is sterile. At that time, the manufacturing tank is taken to the filling line and is aseptically connected; the filling operation is then run. Subsequent to filling we take it through the capping operation and then put the media into incubation for 14 additional days. The number of contaminants is then counted based on turbidity in the container.

## **Question for Dr. Korczynski:**

If one definition of total quality is safety of the product, is the addition of a preservative to facilitate sterility assurance an acceptable quality attribute?

## **Answer by Dr. Korczynski:**

You generally would not consider a preservative to enhance the sterility assurance of the operation. The purpose of a preservative is to facilitate storage and stability in the hands of the person in the field if one has a multi-usage dosage form. It is expected that a preservative would be included in a multi-usage dosage form in a small volume parenteral.

# Question for Dr. Korczynski and Dr. Enzinger:

Can data from media fills be quoted as SAL?

## **Answer by Dr. Korczynski:**

I think that the answer to that question is going to require some revision of thought. In actuality, I don't think that sterility assurance level is the appropriate term for media fills. It is probably more appropriate where you have measurable quantitative inactivation kinetics. I think it is better to talk about contamination rates and address the permissible number of positive units to yield at least a 10% or less contamination rate in the batch and to avoid the use of sterility assurance levels.

## **Answer by Dr. Enzinger:**

I think, precisely speaking, media fills are a measure of the process contamination rate. How that correlates to the product contamination rate is difficult to determine, especially when the product is inimical to microbial growth or when there is a preservative in the product. If you consider media fills as a process contamination rate, it would be a worst case estimate of what the sterility assurance level for a product is.



## Question for Dr. Enzinger:

For small organisms such as *Pseudomonas cepacia* that may pass through a 0.2  $\mu\text{m}$  filter, how do you assure a sterility assurance level of  $10^{-6}$  in the filtered bulk?

## **Answer by Dr. Enzinger:**

You are referring to a nominal pore size when talking about a 0.2 micron filter. There are populations of pores that are both smaller and larger than 0.2 microns. In the filtration mechanism, capture can occur on the surface of the filter if the product is larger than the pore. Capture can also occur within a tortuous path if the organism is smaller than the pore and you can to a certain degree add adsorption to the filter. This means that in many cases small microorganisms, smaller than a nominal pore size or even a virus, may adsorb to the filter. This adsorption phenomena will be very dependent on the type of product which you are passing through the filter. Through various experiments at Upjohn, we have not seen any passage through the filter regardless of the type of product that we were evaluating.

# **Question for Dr. Wartenberg, UMDNJ — Robert Wood Johnson Medical School, U.S.A.:**

Do you see any application of your hazard evaluation methods to the issue of sterility assurance levels and probability of infection?

## **Answer by Dr. Wartenberg:**

I think that the methods could be adapted and then applied to that type of problem. I think the first issue is to determine what you want to look at, whether it is the probability of infection or another concern.

# Question for Mr. Young, Baxter Healthcare Corporation, U.S.A.

How do ISO and CEN standards interact? Will ISO standards replace CEN standards or vice versa?

## **Answer from Mr. Young:**

It is unlikely that CEN standards will replace ISO standards because the CEN standards have been developed for a specific need within Europe to address the European directives. I think that there is a good working arrangement between people all over the world. Whether or not the ISO and CEN standards will be fully harmonized on the first pass is yet to be determined. Although both the CEN and ISO standards are coming closer and closer to each other, my guess is that there will be CEN standards to support the directives in Europe and there will be ISO standards that will be published to support the international requirements. What I really hope for is that in the first revision of these documents we have a joint working group to address sterilization requirements on a global basis.

## **Question for Mr. Saylor, Virginia, U.S.A.**

Why should our industry become more proactive than it already is?

## **Answer by Mr. Saylor:**

There is nothing wrong with the status quo per say. Times are changing rapidly and we are faced with dealing with an enormous quantity of information. For example, as we try to apply 50 and 100 kW accelerators to processing we are going to have to rely on enormous volumes of data to tell us what is going on with the process. Within our own industry, however, there does not appear to be an enormous amount of experience or expertise in the area of large data set analysis. I think that by becoming more proactive and studying the problem now, we will have headed off any problems that may appear later on.